



2015 Northern California
SAILING CALENDAR
AND YRA MASTER SCHEDULE

A Complete Racing Guide

Latitude 38 Publications

Pick one up. It's **FREE!**



The **UNRATED**



'Soozal' King 40



'Whiplash' MC 38



J/70

World-beating rigging available on

ADVANTAGE

Easom Racing and Rigging Wants To Be Your Rigging Company

Easom Rigging is the greatest 'unrated' advantage you can have for your 2015 racing season.

PHRF, One-design, offshore or inshore there isn't a boat on the ocean we can't make faster. The difference is the experience we bring from the grand prix circuit to share with customers large and small.

We put our best into every project we do. Call us for a fast, efficient, cost-effective rigging makeover today.

**Specialization Makes Us
More Effective and
More Affordable**



Easom Racing and Rigging

1150 Brickyard Cove Rd. Suite B1
Point Richmond, CA 94801

(510) 232-SAIL (7245)

www.easomrigging.com



'Eight Ball' Farr 30

San Francisco Bay!



CONTENTS

Welcome to the YRA	6
YRA Contact Information	8
2014 Season Winners	10
Sponsoring Clubs	12
Yacht Club Alphabet Soup	14
Additional Associations	14
PHRF Committee	16
New Equipment Requirements	18
Beer Can Racing	20-24
Midwinter Series	26-27
Shorthanded Circuit	28
One Design Fleets	31
Fleet Schedules	30-32
Women's Circuit	34-35
Caribbean Circuit	36
Pacific Ocean Events	38
YRA Racing Areas	39-40
South Bay Marks	42
Central Bay Marks	44-45
North Bay Marks	46
Racing Rules	47
NCPHRF Application How-To	48-56
YRA Races	49-55
PHRF Application	57
Race Signal Flags	58
Monthly Calendar Pages	59-81
Youth Sailing	60-70
Lake Circuit	72-78
College Sailing	80
SF Bay Current Charts	82-85
Weekend Currents	86-88
Sunrise/Sunset Times	87
<i>Latitude 38</i> Contact Information	87
VHF Radio Channel Uses	90
Advertisers Index/Alpha Index	90

COVER PHOTO: Leslie Richter / www.rockskipper.com
 Graphic Design: *Latitude* / Colleen Young

Questions concerning the 2015 YRA Calendar should be addressed to the YRA office at (415) 771-9500 or the appropriate class association.

Check the monthly edition of *Latitude 38* and www.latitude38.com for calendar updates.

WE
FLY
K
O
O



**READY
TO GO THE
DISTANCE**

- :: Uncompromising Attention to Detail
- :: Unparalleled Customer Service
- :: Unlimited Possibilities

Long before the excitement of the race or the relaxation of the cruise, a lot of thought and years of experience go into making sails that are easy to trim and offer **Speed, Durability** and **Value**. Creating sails that deliver on all fronts demands the very best design and engineering expertise, the finest materials and construction, and the ongoing support for which Doyle is known.

Contact your local Doyle loft to find out how you can have it all.

Better Engineered Sails.



DOYLE

www.doylesails.com

DOYLE SAN FRANCISCO

Bill Colombo

Josh Butler

(510) 523-9411

THE YRA WELCOMES YOU TO THE 2015 RACING SEASON

Welcome to the YRA's 2015 Racing Season! As always, we've got the best racing value and lots of racing opportunities for everyone, whether you sail a multihull, a classic woody or a one-design boat, sail on the ocean or under PHRF in the Bay.

This publication serves as your reminder that it's time to renew your PHRF certificate and time to sign up to race! You can renew your PHRF certificate online at www.yra.org. No form is needed for a straightforward renewal. If you have changes to make, contact the YRA office for more information. An application for a new certificate is included in this publication.

For 2015, the YRA Racing Season offers four different racing options:

- YRA Spring & Summer Series: Each is a three-day series, generally with two races each race day. Divisions for one-design boats, sport boats and PHRF boats.
- OYRA: Nine fully-crewed ocean races this year, with divisions for shorthanded crews.
- Wooden Boat Series: A full schedule of in-the-Bay racing for Bears, Birds, IODs, Folkboats and Knarrs.
- Weekend Regattas: The Great Vallejo Race, the Westpoint Regatta, the 2nd Half Opener and the Season Closer. YRA's four marquee events with divisions for all types of racers.

You can find information on the different racing opportunities in this publication and on the YRA website. When you're ready to sign up, visit www.yra.org to enter electronically.

We encourage everyone to get a YRA membership and sign up to race. Your membership support and participation in the YRA all goes to help us do everything we do. And we do a lot:

- Administer the local PHRF database; more than 400 certificates were issued in 2014.
- Coordinate with the U.S. Coast Guard to process event permits; more than 900 permits in 2014.
- Maintain racing buoys on the Bay.
- Host the US Sailing Area G Appeals Committee.
- Advocate for sailing and racing in the Bay Area.
- Offer great racing.

As always, we want to thank the YRA member yacht clubs and their race committees who are sponsoring this year's YRA races. We couldn't do it without you and your support. We know each YRA skipper and crew thanks you as well.

Be sure to follow us on Twitter and Facebook to keep up with all the latest YRA news. You can find us on Twitter at YRAofSFBay and on Facebook at the YRA of SF Bay page.

Get those certificates renewed, get your entries in, and we look forward to seeing you out on the starting line for every race you're scheduled to sail!

Fair winds to all,

Charles Hodgkins, Chairman of the Board, chairman@yra.org
Laura Paul, Executive Director, info@yra.org
Yacht Racing Association of San Francisco Bay
1070 Marina Village Parkway, #202-G, Alameda, CA 94501
Phone (415) 771-9500 • Fax (415) 276-2378
info@yra.org • www.yra.org



Charles Hodgkins



Laura Paul

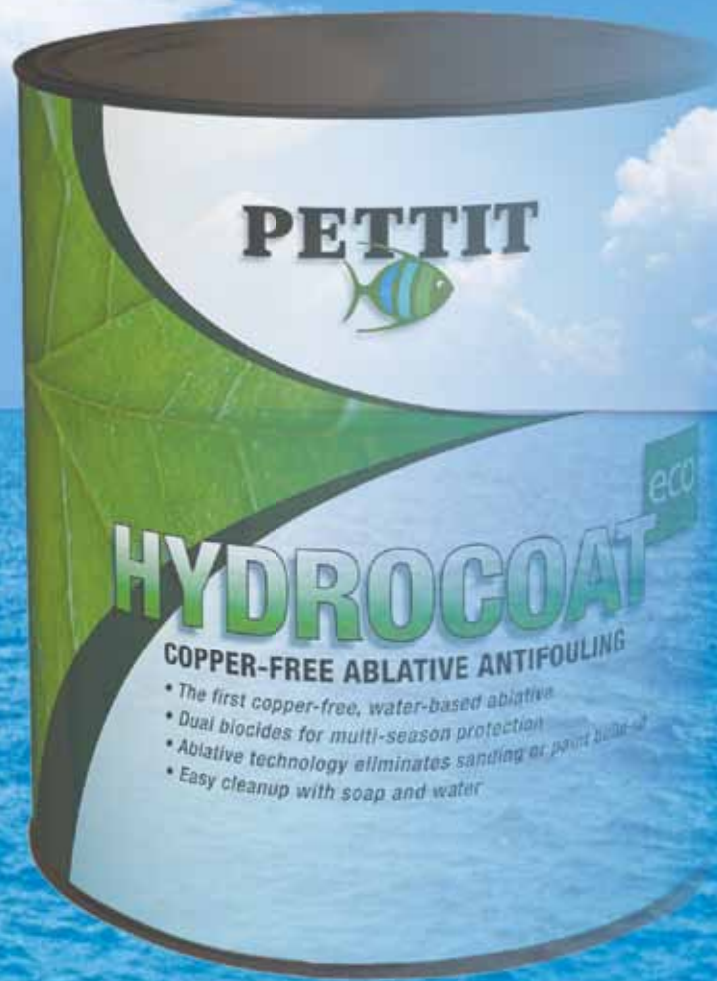

AIR AND SEA WILL NEVER KNOW.

All you sceptics who believe you can't get real fouling protection without heavy loads of copper and solvent, meet the mind changer. Hydrocoat ECO. Water-based Hydrocoat ECO is a new clean world of solvent-free antifouling. It contains the breakthrough additive Econeal that reduces copper by 100% yet delivers 100% of the copper effectiveness. It's all about maximum protection with minimum impact. It's a clean new day.



HYDROCOAT eco

Copper-Free Ablative Antifouling

www.pettitpaint.com • 800-221-4466



Oakland Yacht Club

**CELEBRATING
100 YEARS
1913-2013**

2015 Racing Events

Sunday Brunch Series

**January 4, January 18
February 1, February 15
March 1**

First Gun 12:00
Brunch (9am to 1pm)
New racers always welcome.

Rites of Spring

Saturday, March 14

*Singlehanded, Doublehanded
and Women-Only Full Crew.*

Sweet Sixteen

Wednesday Night Series

**April 29 • May 6-27
June 3-17
July 15-29 • August 5-26
September 2**

First Gun 18:00
*Challenging courses in protected waters.
Great food, fun and prizes at the
clubhouse afterwards.*

Oktoberfest

Saturday, October 3

*Celebrate the spirit of Lederhosen and Drindl
in a race around Treasure Island to the
clubhouse and have beer, brats and prizes!*

- Please join us on race day for a cocktail or meal
- Awards given after every race
- Guest docks available

See our website for race details and entry forms
www.oycracing.net

Sail, Motor, or Drive to OYC
N37 47.008, W122 15.096
1101 Pacific Marina, Alameda, CA 94501
Phone: (510) 522-6868
Fax: (510) 522-7378
email: oycracecom@gmail.com
Accepting new member applications.

YRA CONTACTS

BOARD OF DIRECTORS

CHAIRMAN OF THE BOARD* 2014-2015: Charles Hodgkins
Hm (510) 504-4076, chairman@yra.org

IMMEDIATE PAST CHAIRMAN* 2014-2015: Gerry Brown
Wk (408) 245-6560, mintaka.4@gmail.com

SECRETARY* 2014-2015: Bob Naber
Hm (510) 769-0309, k38bob@aol.com

TREASURER* 2014-2015: Bobbi Tosse
Hm (925) 939-9885, Fax (925) 906-9282, bobbii@jfcbat.com

EXECUTIVE DIRECTOR: Laura Muñoz
Wk (415) 771-9500, Cell (415) 994-4711,
Fax (415) 276-2378, info@yra.org

**Executive Committee*

MEMBER AT LARGE 2014-2015: Paul Kamen
Hm (510) 540-7968, Fax (510) 540-6324, pk@well.com

MEMBER AT LARGE 2014-2015: Tom Reed
Hm (415) 789-1903, dwntrs@aol.com

SERIES PRESIDENTS

In The Bay Series (Includes HDA/ODCA): Don Ahrens
Hm (415) 412-4979, ahrens.don@gmail.com

Ocean Series/OYRA: Andy Newell
(408) 391-0963, andy.newell@sbcglobal.net

Wooden Boat Series (WBRA): Robert Thalman
Hm (415) 479-3281, Fax (415) 499-8077, bobthalman@aol.com

WBRA, YRA REPRESENTATIVE: Don Wilson
Hm (510) 527-1619, windansea@sprintmail.com

COMMITTEES

BUOYS: Nick Salvador
Hm (510) 406-5169, nick.salvador@gmail.com

PHRF: (415) 771-9500, phrf@yra.org
See page 16 for PHRF (Performance Handicap Racing Formula) committee.

RACE MANAGEMENT: Nancy DeMauro
(415) 630-0002, ndemauro@hotmail.com

US SAILING

DIRECTOR, AREA G: John Siegel
Hm (408) 234-0422, jasiegel@earthlink.net

AREA REGIONAL ADMINISTRATIVE JUDGE: John Christman
Hm (510) 797-5524, Cell (510) 410-6771,
Fax (510) 790-3273, john.christman@jc2tech.com

ARO, AREA G: Nancy DeMauro
(415) 630-0002, ndemauro@hotmail.com

APPEALS COMMITTEE

John Christman, Hm (510) 797-5524, Cell (510) 410-6771,
Fax (510) 790-3273, john.christman@jc2tech.com

Mike Gross, (831) 476-2054, mike.gross@charter.net

Paul Kamen, Hm (510) 540-7968, Fax (510) 540-6324, pk@well.com

Tom Roberts, Hm/Wk (415) 898-7802, tensleyrob@aol.com

John Siegel, (408) 234-0442, jasiegel@earthlink.net

Latitude 38 has made every effort to ensure the accuracy of all information, but please confirm your schedule with your fleet captain and look in the monthly Latitude 38 Race Calendar or on www.latitude38.com for changes. Due to space limitations, not all information could be included.



CAN A BOATYARD PREDICT THE FUTURE?

The future can be tricky to predict, but what Bay Marine Boatworks can do is guarantee your complete satisfaction when you bring your boat to us for maintenance and repair.

All too many boatyards promise you the moon, and in the end you find yourself paying for it. Here is our promise to you: We will inspect the work you require on your boat, and from that inspection we'll tell you exactly what we will do to fix it, how much it will cost, and when we will finish the work. All three of these commitments are guaranteed.

Even though the future is unknown, we do guarantee that when you make the important decision to bring your boat to Bay Marine Boatworks, you will find that we will do whatever it takes to make you absolutely satisfied when you leave the yard.

our mission is to guarantee absolute satisfaction to every customer



310 West Cutting Blvd., Point Richmond, CA 94804

Tel. 510.237.0140

office@baymarineboatworks.com

www.baymarineboatworks.com

CONGRATULATIONS 2014 SEASON WINNERS

YRA Spring Series

PHRF 1: *Mintaka 4*, Farr 38, Gerry Brown, BYC
PHRF 2: *Nancy*, Wyliecat 30, Pat Broderick, SSS
Olson 25: *American Standard*, Robert Gunion, BYC
Santana 22: *Oreo*, Garth Copenhaver, SSS

YRA Summer Series

PHRF 1: *Mintaka 4*, Farr 38, Gerry Brown, BYC
PHRF 2: *Shameless*, Schumacher 30, George Ellison, BYC
Olson 25: *American Standard*, Robert Gunion, BYC
Santana 22: *Oreo*, Garth Copenhaver, SSS
Cal 20: *Can O'Whoopass*, Richard vonEhrenkrook, SFYC

OYRA Series

PHRO 1: *Elan*, Express 37, Jack Peurach
PHRO 2: *Whirlwind*, Wyliecat 30, Dan Benjamin, OYC
SHS 1: *Racer X*, J/105, Mary McGrath, EYC
SHS 2: *Nancy*, Wyliecat 30, Pat Broderick, SSS
Multihulls: *Raven*, Corsair F-27, Truls Myklebust, BAMA

YRA-WBRA

Bear: *Smokey*, Stephen Robertson, StFYC
Bird: *Oriole*, Hugh Harris & Jock MacLean, SFYC
Folkboat: *Polperro*, Peter Jeal, BVBC
IOD: *Fjaer*, Richard & Mark Pearce, SFYC
Knarr: *Flyer*, Chris Kelly, RYC

SSS

Singlehanded Monohull: *Elise*, Express 27, Nathalie Criou, RYC
Singlehanded Multihull: *Tri N Fly*, F-27 trimaran, David Morris, HMBYC
Doublehanded Monohull: *Arcadia*, Modified Santana 27, Gordie Nash/Ruth Suzuki, RYC
Doublehanded Multihull: *Roshambo*, Corsair 31R trimaran, Darren Doud/Chris Lewis, SSS

Small Boats

El Toro Seniors: *Cygnus*, Art Lange, FSC/HPSC
El Toro Juniors: Josselyn Verutti, SCYC
Mercury: *Fast Break*, Randy Smith, SFYC
Vanguard 15: Al Sargent, StFYC
Laser: *Seaweed Magnet*, Emilio Castelli, SRSC
Laser Radial: Laird Henkel, No YC

And More...

BAADS: Cristina Rubke, Liberty/Hansa 12, BAADS
BAMA Cup: *Ma's Rover*, Corsair F-31, Mark Eastham, BAMA
BAMA Fast Cat: *Shadow*, ProSail 40, Peter Stoneberg, StFYC
Etchells: *Imp*, Dale Hoffman
Express 27: *Wile E Coyote*, Dan Pruzan, EYC
Express 37: *Golden Moon*, Express 37, Kame Richards, EYC
Islander 36: *Califia*, Tim Bussiek, SSS
J/105: *Blackhawk*, Ryan Simmons, SFYC
J/111: *MadMen*, Dorian McKelvy, StFYC
J/120: *Chance*, Barry Lewis, StFYC
Melges 20: *Kuai*, Daniel Thielman, CYC
Melges 24: *Insolent Minx*, Zhenya Kirueshkin-Stepanoff, SCYC
Moore 24: *Paramour*, Rowan & Vikki Fenell, RYC
Open 5.70: *Frolic*, Marc Finot, SeqYC



LESJIE RICHTER / WWW.ROCKSKIPPER.COM

Go get 'em in 2015!



ENCINAL YACHT CLUB PRESENTS SUMMER SAILSTICE 2015

A Global Celebration of Sailing

SATURDAY
JUNE 20

- ☀ Sailstice Small Boat Races
- ☀ Compete in boat building contest
- ☀ Cruise in to EYC Sailstice Festival
- ☀ Music, food, activities
- ☀ Join the 'Estuary Stroll and Sleepover'

Learn more and sign up to win from over 400 prizes at
www.summersailstice.com/sf

EYC 2015 CALENDAR

JUNIOR SAILING PROGRAM

Year Round: (510) 769-0221

JACK FROST MIDWINTERS

January 10, February 21, March 14, November 14

BAYS OPTI REGATTA

February 14-15

MERCURY SERIES

March 7, April 11, May 9, June 6

SMALL BOAT SPRING & SUMMER SERIES

March 21 through September 19

FRIDAY NIGHT ESTUARY

SPRING & SUMMER TWILIGHT SERIES

April 10 through September 11

ESTUARY CUP

April 12

PCISA SILVER CHAMPIONSHIPS

April 25-26

COASTAL CUP TO SANTA BARBARA

Starts June 3-4

SUMMER SAILSTICE

June 20

SVENDSEN'S SUMMER SPLASH

July 11-12

GRACIE & GEORGE REGATTA

August 23

MILLIMETER NATIONALS

September 12-13

COMMODORE'S CUP

September 13

NORCAL HS PUMPKIN REGATTA

October 17-18



See website for complete calendar of EYC events

Guests are invited to visit the Club, in Alameda, by land, sea or the web
ACCEPTING MEMBERSHIP APPLICATIONS

For Race, Berthing, Dining & Membership Information, call (510) 522-3272

www.encinal.org



YOUR SAILING RESOURCE!

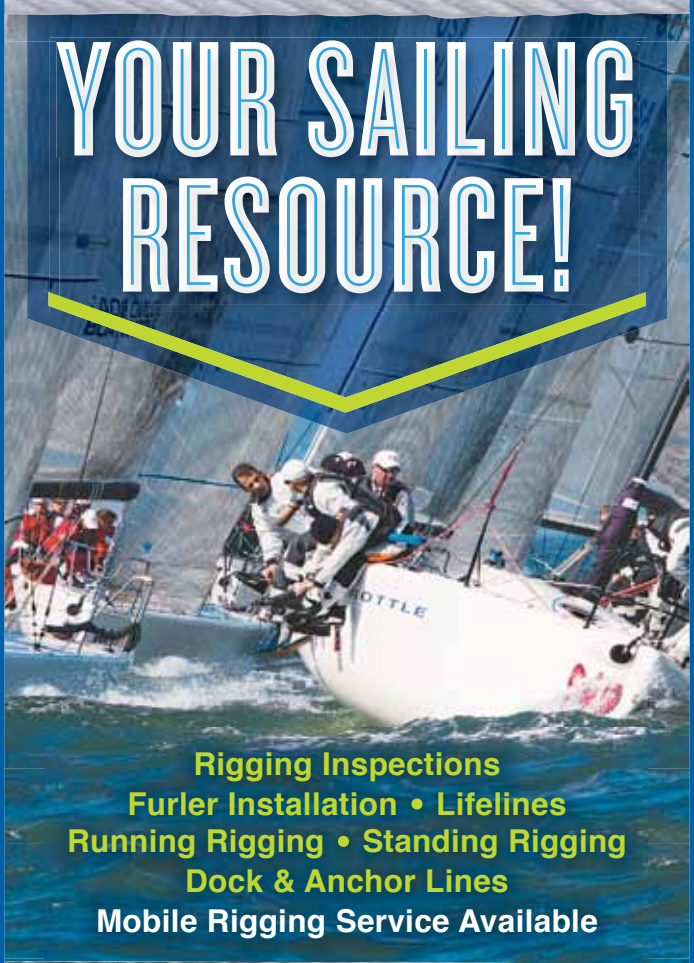

Rigging Inspections
Furler Installation • Lifelines
Running Rigging • Standing Rigging
Dock & Anchor Lines
Mobile Rigging Service Available



888-447-RIGG (7444)

Drop off your rigging orders at the store nearest you!

Or visit our Onsite Rigging Locations in:

- Alameda, CA** • 730 Buena Vista Ave. • (510) 521-4865
- Newport Beach, CA** • 3433 Via Lido • (949) 645-1711
- San Diego, CA** • 1250 Rosecrans St. • (619) 255-8844
- Seattle, WA** • 1827 15th Ave. W., Ste. A22 • (206) 926-0356

www.westmarine.com/rigging

SPONSORING CLUBS

- BERKELEY YACHT CLUB (BYC)** • (510) 843-9292
Bobbi Tosse c/o BYC, 1 Seawall Drive, Berkeley 94710
- CORINTHIAN YACHT CLUB (CYC)** • (415) 789-9206
Donal Botkin c/o CYC, 43 Main Street, Tiburon 94920
- ENCINAL YACHT CLUB (EYC)** • (925) 930-0247
Doug Perry c/o EYC, 1251 Pacific Marina, Alameda 94501
- GOLDEN GATE YACHT CLUB (GGYC)** • (415) 346-BOAT
Dennis Bush c/o GGYC, 1 Yacht Road, San Francisco 94123
- HALF MOON BAY YACHT CLUB (HMBYC)** • (650) 728-2120
Steve Smith c/o HMBYC, PO Box 52, El Granada 94018
- RICHMOND YACHT CLUB (RYC)** • (510) 237-2821
Doug McVae c/o RYC, PO Box 70295, Pt. Richmond 94807
- ST. FRANCIS YACHT CLUB (StFYC)** • (415) 563-6363
Melanie Roberts c/o StFYC, On the Marina, San Francisco 94123
- SAN FRANCISCO YACHT CLUB (SFYC)** • (415) 789-5647
Lisa Turner c/o SFYC, PO Box 379, Belvedere 94920
- SAUSALITO YACHT CLUB (SYC)** • (415) 331-9147
Chuck Cihak c/o SYC, PO Box 267, Sausalito 94966
- SEQUOIA YACHT CLUB (SeqYC)** • (650) 364-9643
Rick Dalton c/o SeqYC, 441 Seaport Court, Redwood City 94063
- SOUTH BEACH YACHT CLUB (SBYC)** • (650) 302-1187
Gerard Sheridan c/o SBYC
Pier 40 On the Embarcadero, San Francisco 94107
- VALLEJO YACHT CLUB (VYC)** • (707) 643-1254
Dave Nadolne c/o VYC, 485 Mare Island Way, Vallejo 94590



Thanks to all yacht clubs, advertisers and race committees for their support!

MARTHA BLANCHFIELD

PHOTO BY: JOY SAILING



MOVING FORWARD

More technology. More expertise. More service.
The same sailmaking team—

Santa Cruz Sails is now Ullman Sails



Ullman Sails San Francisco & Monterey Bay

Santa Cruz, CA | 831.454.0868 | dhodges@ullmansails.com

Synthia Petroka
510.454.0868

Robin Sodaro • 415.332.4117
rsodaro@ullmansanfrancisco.com

CLIP AND SAVE! ✂

PIRATES + LAIR 2015 SAVINGS! 5 — 10 — 15 SALE

5% OFF—Club and Team Orders*

Save 5% off any custom yacht club or racing team order over \$150.

*Valid for one order per customer in 2015.

10% OFF—Regattas

Save 10% on Pirates Lair regatta merch at any regatta with the Pirates Lair pop-up tent. Long Beach Race Week and The Great Vallejo Race are on the list! You must present this coupon to a PL pirate to receive the discount, so cut out and save!

15% OFF—Online Store

Use coupon code 15LAT38 for 15% off at store.pirateslair.com. Expires 12-31-15.

CLIP AND SAVE! ✂

Gill Hanes

CUTTER & BUCK

GILDAN
ACTIVEWEAR

PORT AUTHORITY



PIRATES + LAIR 888.SAIL.BUM

WWW.PIRATESLAIR.COM

©2014 Mount Gay Distilleries Ltd., Mount Gay® Barbados Rum, 40% Alc/Vol., Imported by Rémy Cointreau USA, Inc., New York, N.Y. Eclipse Design® Be Confident. Drink Responsibly.

YACHT CLUB ALPHABET SOUP

ABYC	Alamitos Bay Yacht Club	LYSA	Lake Yosemite Sailing Association
AYC*	Alameda Yacht Club	MBYC	Mission Bay Yacht Club
AeoYC*	Aeolian Yacht Club	MMBA	Master Mariners Benevolent Association
BAADS	Bay Area Association of Disabled Sailors	MPYC*	Monterey Peninsula Yacht Club
BAMA*	Bay Area Multihull Association	MYC*	Marin Yacht Club
BBYC*	Ballena Bay Yacht Club	NHYC	Newport Harbor Yacht Club
BVBC*	Bay View Boat Club	NOSA	Newport Ocean Sailing Association
BYC*	Berkeley Yacht Club	OPYC*	Oyster Point Yacht Club
BenYC*	Benicia Yacht Club	OYC*	Oakland Yacht Club
CBYC	Cabrillo Beach YC	PCYC	Pacific Cup Yacht Club
CGRA	Columbia Gorge Racing Association	PICYA	Pacific Inter-Club Yacht Association
CMA	Cal Maritime Academy	PYSF	Peninsula Youth Sailing Foundation
CN	Club Nautique	PresYC*	Presidio Yacht Club
CPYC*	Coyote Point Yacht Club	RYC*	Richmond Yacht Club
CSC*	Cal Sailing Club	SBYC*	South Beach Yacht Club
CYC*	Corinthian Yacht Club	SCYC*	Santa Cruz Yacht Club
CalYC	California Yacht Club	SDY	San Diego Yacht Club
DSC*	Diablo Sailing Club	SFYC*	San Francisco Yacht Club
EYC*	Encinal Yacht Club	SJYC*	San Jose Yacht Club
EikYC*	Elkhorn Yacht Club	SLYC	San Leandro Yacht Club
EmYC*	Emeryville Yacht Club	SPYC*	Sierra Point Yacht Club
FLYC*	Folsom Lake Yacht Club	SRYC*	San Rafael Yacht Club
FSC	Fremont Sailing Club	SSC*	Stockton Sailing Club
FYC*	Fresno Yacht Club	SSS*	Singlehanded Sailing Society
GCYC*	Gold Country Yacht Club	SYC*	Sausalito Yacht Club
GGYC*	Golden Gate Yacht Club	SeqYC*	Sequoia Yacht Club
HLBC	Huntington Lake Boat Club	StFYC*	Saint Francis Yacht Club
HMBYC*	Half Moon Bay Yacht Club	TISC	Treasure Island Sailing Center
HRYC	Hood River Yacht Club	TIYC*	Treasure Island Yacht Club
HYC	Humboldt Yacht Club	TPYC	Transpacific Yacht Club
IYC*	Island Yacht Club	TYC*	Tiburon Yacht Club
InvYC*	Inverness Yacht Club	Tahoe YC*	Tahoe Yacht Club
LAYC	Los Angeles Yacht Club	VYC*	Vallejo Yacht Club
LBYC	Long Beach Yacht Club	WSC*	Whiskeytown Sailing Club
LGYC*	Los Gatos Yacht Club		
LMSC	Lake Merritt Sailing Club		
LTWYC*	Lake Tahoe Windjammers Yacht Club		
LWSC	Lake Washington Sailing Club		

*YRA Member Clubs

ADDITIONAL ASSOCIATIONS

- **BAADS:** Bay Area Association of Disabled Sailors (415) 281-0212, www.baads.org
- **BAMA:** Bay Area Multihull Association
Bob Naber, sfbchair@sfbama.org, Ross Stein, racechair@sfbama.org, www.sfbama.org
- **BAYS:** Bay Area Youth Sailing
www.bayarea-youthsailing.com
- **MMBA:** Master Mariners Benevolent Association (415) 364-1656, www.mastermariners.org
- **NCORC:** Northern California Ocean Racing Council
www.norcalorc.org
- **PICYA:** Pacific Inter-Club Yacht Association
Lynda Myers, (415) 602-9961, lyndapicya@gmail.com, www.picya.org
- **SSS:** Singlehanded Sailing Society
Jim Quanci, (866) 724-5777, racechair@sfbaysss.org, sail@sfbaysss.org, www.sfbaysss.org
- **U.S. COAST GUARD** (Marine Event Permits):
(415) 399-3440, Fax (415) 399-3480, www.uscg.mil
- **US Sailing:**
15 Maritime Dr., Portsmouth, RI 02871
(401) 683-0800, (800) USSAIL1, info@ussailing.org, www.ussailing.org

FRICTION DEVICES



MXL SNATCH RINGS

Optimal Weight To Working Load Ratio

MXL soft blocks are ideal for applications where lines are under heavy semi-static loads. Featuring higher working loads than standard blocks of the same size, the MXL improves onboard performance. Used as a snatch block, it can be easily installed and removed in a few seconds. It is also a great product to keep as a spare for any emergency situation.

Model	Max Line Ø	Height	Weight oz	WL lbs
MXL6	8mm - 5/16"	35mm - 1 3/8"	.70	1,985
MXL8	10mm - 3/8"	45mm - 1 3/4"	1.41	3,086
MXL10	14mm - 9/16"	55mm - 2 5/32"	2.89	3,968



FRX RINGS

Reliability, Light Weight And Versatility

FRX Rings are ideal for applications where lines are under heavy semi-static loads, or to defect lines throughout the boat. Rigged with a soft attachment, the FRX ensures light weight and effective angle deflection for multiple applications onboard.

Model	Ø A	Ø B	WL lbs	Weight oz
FRX 6	13/16"	9/32"	881	.07
FRX 10	5/16"	3/8"	1,763	.17
FRX 15	3/8"	19/32"	3,527	.42
FRX 20	9/16"	25/32"	7,054	1.09
FRX 25	21/32"	63/64"	11,023	2.01

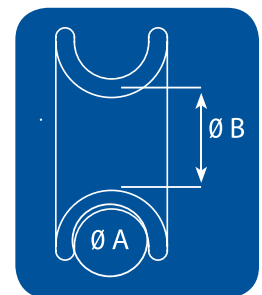
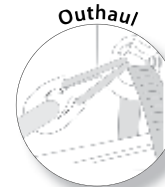

www.wichardamerica.com

Wichard Inc

Tel: +1 (401) 683-5055 | Fax: +1 (802) 655-4689 | Email: info@wichard-usa.com

Wichard
When Life Depends On It

License #0E32738

TWIN RIVERS MARINE INSURANCE

AGENCY, INC.

"Your Marine Insurance Specialists"

**7 Marina Plaza • Antioch, CA 94509
At The Antioch Marina**

Latitude 38° -01'10" N • Longitude 121° 49'10" W • Buoy 4 Red



Your
Twin Rivers
Policy Comes With
An Agent!



www.BoatInsuranceOnly.com
(800) 259-5701

Insurance made simple, affordable and effective.

Representing...

TRAVELERS

ace seguros

INTERNATIONAL
MARINE
UNDERWRITERS

CHUBB
PERSONAL
INSURANCE

SEAWORTHY
Insurance Company
A Berkshire Hathaway Company

insured.

AIG

RED SHIELD
INSURANCE COMPANY

MARKEL INSURANCE COMPANY

Years of unbeatable experience to
match your needs to the right product.

Worldwide Coverage

West Coast □ Hawaii □ Alaska □ Mexico
East Coast □ Caribbean □ Pacific □ Atlantic

PHRF COMMITTEE 2015

If you have a custom or modified sailboat, your boat may need to have its rating reviewed and assigned by the local volunteer PHRF committee. With your boat's measurements, the committee will provide a fair rating so you can quickly join the Bay Area racing scene. From evening beer can racing to offshore regattas to just about every other keelboat race on the Bay, a PHRF rating will make it easy to sign up and start sharpening your skills on the race course. You can fill out the rating form on page 57 with help from detailed instructions provided on page 48.

The YRA also wants to thank the committee members below for their tireless efforts at supporting fun, fair racing on San Francisco Bay.

Antrim, Jim

Wk (510) 223-9680, Fax (510) 262-0303,
jka@antrimdesign.com

Colombo, Bill

c/o Doyle Sails, Wk (510) 523-9411, Cell (510) 773-8015,
Fax (510) 523-9433, bcolombo@doylesails.com

Dees, Brooks

Wk (510) 691-2009, bdyd@comcast.net

Gurrola, George

Hm (510) 843-9417, ggurrola@comcast.net

Honey, Stan

Hm phone/fax (650) 328-3428, Wk (650) 961-7825,
Cell (650) 269-3428, stanhoney@msn.com

Richards, Kame

Pineapple Sails, Hm (510) 522-3109, Wk (510) 522-2200,
Fax (510) 522-7700, kame@pineapplesails.com

Sodaro, Robin

Hood Sails, Hm (415) 381-1223, Wk (415) 332-4104,
Cell (415) 279-4104, Fax (415) 332-0943, hoodsails@aol.com

Wijsen, Seadon

seadon.wijsen@northsails.com

Administrative Support: Laura Muñoz

1070 Marina Village Pkwy., #202-G, Alameda, CA 94501
Wk (415) 771-9500, Fax (415) 276-2378, phrf@yra.org



Strictly Sail Pacific

April 9-12, 2015

Jack London Square • Oakland, CA

THE WEST COAST'S ONLY

All-Sail BOAT SHOW!

MORE BOATS! The best selection of brands at the best prices in one location

New model introductions

FREE Sailboat rides

Shop and save on a huge selection in the sailing gear and accessories pavilion

Daily seminars from top names in sailing

Live music & special entertainment for all ages

Visit StrictlySailPacific.com
for tickets and show details



Find us on:
facebook



#SSPAC15



NEW EQUIPMENT REQUIREMENTS FOR ALL IN-THE-BAY YRA RACES

These requirements are for races held within San Francisco Bay. Please note that OYRA races have separate requirements which can be found at www.norcalorc.org/gear.

- 1.1 These Minimum Equipment Requirements establish uniform minimum equipment and training standards for a variety of boats racing in San Francisco Bay under YRA. These regulations do not replace, but rather supplement, the requirements of the U.S. Coast Guard, the Racing Rules of Sailing (RRS), the rules of Class Associations and all applicable rating rules.
- 1.2 The safety of a boat and her crew is the sole and inescapable responsibility of the “person in charge,” as per RRS 46, who shall ensure that the boat is seaworthy and manned by an experienced crew with sufficient ability and experience to face bad weather. S/he shall be satisfied as to the soundness of hull, spars, rigging, sails and all gear. S/he shall ensure that all safety equipment is at all times properly maintained and safely stowed and that the crew knows where it is kept and how it is to be used.
- 1.3 A boat may be inspected at any time by an inspector or measurer of the Organizing Authority. If she does not comply with these regulations her entry may be rejected, or will be liable to disqualification, or such other penalty as may be prescribed by the race protest committee.
- 1.4 All equipment required shall function properly, be regularly checked, cleaned and serviced, and be of a type, size and capacity suitable for the intended use and size of the boat and the size of the crew. This equipment shall be readily accessible while underway and, when not in use, stored in such a way that deterioration is minimized.
- 1.5 A boat’s heavy items such as batteries, stoves, toolboxes, anchors, chain and internal ballast shall be secured.
- 2.1 A boat shall have a manual bilge pump of at least a 10 GPM capacity.
- 2.2 A boat shall carry a sturdy bucket of at least two gallons (8 liters) capacity with lanyards attached.
- 3.1 Each crewmember shall have a U.S. Coast Guard approved Type III or Type V life jacket intended for small boat sailing or other active boating.
- 3.2 A boat racing between sunset and sunrise shall carry navigation lights that meet U. S. Coast Guard requirements mounted so that they will not be obscured by the sails nor be located below deck level.
- 3.3 A boat shall carry fire extinguisher(s) that meet U.S. Coast Guard requirements, when applicable.
- 3.4 A boat shall carry a sound-making device that meets U.S. Coast Guard requirements, when applicable.
- 3.6 A boat shall carry U.S. Coast Guard flares meeting day-night requirements not older than the expiration date. Alternately, non-pyrotechnic distress signals (distress flag for day, SOS light for night) which meet USCG requirements may be substituted.
- 3.7 Beginning January 1, 2015, it will be required for a boat to have a throwing sock-type heaving line of 50’ (15m) or greater of floating polypropylene line readily accessible to the cockpit.
- 3.8 A boat shall carry a Coast Guard approved Type IV throwable device.
- 3.9 A boat shall have a VHF radio which may be handheld or fixed mount.
- 3.10 A boat shall have a magnetic compass independent of the boat’s electrical system suitable for steering at sea.
- 3.11 A boat shall have at least one means to navigate (charts, GPS) which is appropriate for the race area and the characteristics of the boat.
- 3.12 A boat shall carry one anchor, meeting the anchor manufacturer’s recommendations based on the yacht’s size, with a suitable combination of chain and line.
- 3.13 A boat shall carry a first aid kit and first aid manual suitable for the likely conditions of the passage and the number of crew aboard.
- 4.1 Annually, two-thirds of the boat’s racing crew shall practice man-overboard procedures appropriate for the boat’s size and speed. The practice shall consist of marking and returning to a position on the water, and demonstrating a method of hoisting a crewmember back on deck, or other consistent means of reboarding the crewmember.



Greg Gorsiski, Artist

Join the fun!

RICHMOND YACHT CLUB

REGATTAS

BIG DADDY *April*
 GREAT PUMPKIN *October*
 BIG DINGHY *April*
 EL TORO STAMPEDE *October*
 OPTI MIDWINTERS *Jan, Feb & Dec*
 MULTI HULL INVITATIONAL *September*
 SMALL BOAT MIDWINTERS *Jan, Feb, Mar & Dec*
 29er NATIONALS *July*
 LITTLE DADDY *January*
 TOTALLY DINGHY *September*
 WOMEN'S 420 *Jan & Feb*
 MEN'S 420 *Jan & Feb*
 BEER CAN races with over 25 boats *April - Sept*
 A world renowned JUNIOR PROGRAM *All year long*



richmondyc.org

510.237.2821

EMAIL rycharbor@richmondyc.org

PERFORMANCE MATTERS

J/Boats and Performance Brokerage



Nobody knows race boats like Sail California.

Buying or selling, we know the market for one design, ORR, PHRF, TP52, custom built... you name it!

If you're looking for a winning season, contact:

SAIL *California*

www.sailcal.com

Alameda
(510) 523-8500

Norman Davant
norman@sailcal.com
Rod Kux
rod@sailcal.com
Drew Harper
drew.harper@me.com
Garrett Greenhalgh
soulofsailing@gmail.com

2015 BEER CAN SERIES

The 2015 Beer Can Series Schedule follows. Beer can races are great venues for sailors to learn racing skills, try out new crew, bring the family, socialize, and have fun.

If your club has a beer can series you would like to list here next year, please email your schedule and contact information to colleen@latitude38.com, or fax it to (415) 383-5816, by November 12, 2015.

BALLENA BAY YACHT CLUB

Friday Night Grillers: 3/20, 4/3, 4/17, 5/1, 5/15, 5/29, 7/10, 7/24, 8/7, 8/21, 9/4, 9/18.

(510) 865-2511, race@bbyc.org, www.bbyc.org

BAY VIEW BOAT CLUB

Monday Night Madness. Spring: 4/13, 4/27, 5/11, 5/25, 6/8, 6/22 (make-up). Fall: 7/20, 8/3, 8/17, 8/31, 9/7, 9/21 (make-up). Terry Mahoney, (408) 210-0517,

racing.bvbc@gmail.com, www.bayviewboatclub.org

BENICIA YACHT CLUB

Thursday Nights: 4/2-9/24. Joe Kallios, (707) 628-2914, race@beniciayachtclub.com, www.beniciayachtclub.com

BERKELEY YACHT CLUB

Every Friday Night: 4/3-9/18. Paul Kamen,

(510) 540-7968, pk@well.com, www.berkeleyyc.org

CAL SAILING CLUB

Sunday morning races year-round; Thursday evening JY15 races April-October, weather and tides permitting. For members only.

racing_chair@cal-sailing.org, www.cal-sailing.org

CORINTHIAN YACHT CLUB

Every Friday Night: 4/17-8/28. Jim Erskine, (415) 847-2460, race@cyc.org, www.cyc.org

COYOTE POINT YACHT CLUB

Every Wednesday Night: 4/15-10/7.

(650) 347-6730, regatta@cpyc.com, www.cpyc.com

ENCINAL YACHT CLUB

Friday Nights. Spring Twilight Series: 4/10, 4/24, 5/8, 5/29, 6/12. Summer Twilight Series: 7/10, 7/24, 8/7, 8/21, 9/11.

Doug Perry, (510) 867-8064, svchoices@att.net, www.encinal.org

continued on page 22

J/105 Fleet #1

San Francisco Bay

**J/105 North Americans
Rolex Big Boat Series
September 17-20**



JOIN OUR 2015 SERIES

We have a full spectrum of events from competitive to more relaxed, recreational racing.

CHAMPIONSHIP EVENTS

CYC One Design Invitational	Spring Invitational
J/Fest	Swiftsure
Rolex Big Boat Series	Summer Keelboat
Spring One Design	

**FINAL 2015 CALENDAR POSTED AT:
www.sfj105.org**

**For more information, or to crew and add your details to the crew list page, go to
www.sfj105.org**

**Crew and potential owners...Join J/105 Fleet #1
80+ boats on the Bay**

**For sales information, go to
www.sailcal.com**

2015 BEER CAN SERIES

continued from page 20

FOLSOM LAKE YACHT CLUB

Wednesday Nights: 5/6-8/26.
Summer Sunset Series: 5/15, 6/12, 7/17, 8/7.
(916) 534-8458, www.flyc.org

GOLDEN GATE YACHT CLUB

Friday Nights: 5/8, 5/22, 6/5, 6/19, 7/3, 7/17, 7/31, 8/14, 8/28. Dennis Bush, (510) 703-5779, bush.sailing@gmail.com, www.ggyc.com

ISLAND YACHT CLUB

Friday Nights. Spring Twilight: 4/10, 4/24, 5/15, 6/5, 6/12. Summer Twilight: 7/10, 7/24, 8/7, 8/21.
John New, (510) 521-2980, iycracing@yahoo.com, www.iyc.org

KONOCTI BAY SAILING CLUB

Every Friday Night: June-August.
OSIRs (Old Salts in Retirement) every Wednesday at noon.
Brad King, chezking@att.net, info@kbsail.com, www.kbsail.com

LAKE TAHOE WINDJAMMERS YACHT CLUB

Wednesday Nights: 5/20-10/7.
ltwyc2@aol.com, www.tahoewindjammers.com

LAKE WASHINGTON SAILING CLUB

Every Thursday Night: May-August.
www.lwsailing.org

LAKE YOSEMITE SAILING ASSOCIATION

Every Thursday Night: May-September.
Dennis Wainwright, (209) 722-1947, speedyw1955@yahoo.com, www.lakeyosemitesailing.org

MONTEREY PENINSULA YACHT CLUB

Sunset Series. Every Wednesday Night: 3/25-9/30;
Summer Solstice Fiasco Race: 6/17.
Victoria Model Yacht Series. Every Wednesday Night: 1/7-3/18 & 10/7-12/16. Every Friday Night: 3/27-10/2.
John Feeley, race@mpyc.org, www.mpyc.org

OAKLAND YACHT CLUB

Sweet 16 Series. Every Wednesday Night: 4/29-6/17 & 7/15-9/2. Jim Hild, (510) 277-4676, oycracecom@gmail.com, www.oaklandyachtclub.com

PRESIDIO YACHT CLUB

Thursday Nights; Crazy Eights: 5/7, 5/21, 6/4, 6/18, 7/2, 7/30, 8/13, 8/27.
Anne Springer, (415) 331-5335, anne.springer@live.com, www.presidioyachtclub.org

RICHMOND YACHT CLUB

Wednesday Nights: 4/1, 4/15, 4/22, 4/29, 5/6, 6/17, 6/24, 7/1, 7/8, 7/15, 7/22, 7/29, 8/5, 8/12, 8/19, 8/26, 9/2, 9/16, 9/23. Eric Arens, (510) 841-6022, saucierimages@comcast.net, www.richmondyc.org

ST. FRANCIS YACHT CLUB

Windsurfing Series, Friday Nights: 4/3, 4/17, 5/1, 5/15, 5/29, 6/12, 6/26, 7/10, 7/24, 8/7, 8/21, 9/11, 9/25.
Kiteboarding Series, Thursday Nights: 4/9, 4/23, 5/7, 5/21, 6/4, 6/18, 7/2, 7/16, 7/30, 8/13, 9/3, 9/10, 9/24.
Wednesday Night Series: 4/29, 5/6, 5/13, 5/20, 5/27, 6/3, 6/10, 6/17, 6/24, 8/5, 8/12, 8/19, 8/26.
J/22 Spring Series, Wednesday Nights: 3/18, 3/25, 4/1, 4/8, 4/15, 4/22.
Melanie Roberts, (415) 563-6363, mroberts@stfyc.com, www.stfyc.com

SANTA CRUZ YACHT CLUB

Wet Wednesdays, every Wednesday Night: 3/11-10/28.
Laser Friday Nights: 4/17, 5/15, 6/19, 7/17, 8/14.
(831) 425-0690, scyc@scyc.org, www.scyc.org

SAUSALITO YACHT CLUB

Tuesday Nights.
Spring Sunset Series: 4/28, 5/12, 5/26, 6/9, 6/23.
Summer Sunset Series: 7/21, 8/4, 8/18, 9/1, 9/15.
Sunset Championship: 9/29.
Chuck Cihak, race@sausalitoyachtclub.org, www.sausalitoyachtclub.org

SEQUOIA YACHT CLUB

Every Wednesday Night: 4/15-10/7.
Hannig Cup: 8/27.
Rick Dalton, (650) 255-5766, sviowa@gmail.com, www.sequoiayc.org

SOUTH BEACH YACHT CLUB

Friday Night Series: 4/17, 4/24, 5/1, 5/15, 5/22, 5/29, 6/5, 6/19, 6/26, 7/17, 7/24, 7/31, 8/7, 8/21, 8/28, 9/11.
Gerard Sheridan, (415) 495-2295, rearcommodore@southbeachyachtclub.org, www.southbeachyachtclub.org

continued on page 24



J[®]

120

Fleet #5

San Francisco



PHOTO: CHRIS RAY / WWW.PRINTROOM.COM/PRO/CRAY/VP



PHOTO: CHRIS RAY / WWW.PRINTROOM.COM/PRO/CRAY/VP

Join the most active and successful 40' one-design fleet on the West Coast!

The J/120 fleet offers competitive racing, friendly rivalries, and a challenging schedule all aboard an elegant, high-performance boat the whole family can enjoy.

For sales information visit:
www.sailcal.com

For more information and our 2015 sailing schedule visit:
www.sf-j120.com or contact **info@sf-j120.com**

SAMSON®

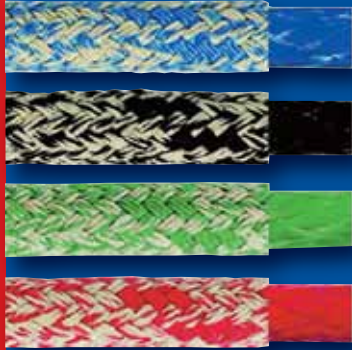

For Custom Splicing Services
Please Call or Email
Rigging@Defender.com

**New &
Improved!**

Warpspeed® II

Features & Benefits:

- Enhanced creep properties
- Excellent abrasion resistance
- Extremely low stretch
- High strength
- Lightweight
- Very low creep

Applications:

- Control Line
- Halyard
- Jib/Genoa Sheet
- Mainsheet
- Spinnaker Guy
- Spinnaker Sheet

MLX

Features & Benefits:

- Can be tapered
- High strength
- Lightweight
- Low stretch
- Samthane-coated core matches the cover

Applications:

- Control Line
- Halyard
- Jib/Genoa Sheet
- Mainsheet
- Spinnaker Sheet

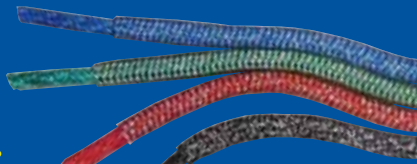

Defender®

Your Discount Outfitting Specialist!
800-628-8225 • info@defender.com

www.defender.com

**WE ARE NOT
REQUIRED
TO COLLECT
SALES TAX ON
ORDERS SHIPPED
OUTSIDE OF CT**

**Most Orders
Placed by 4:30pm
Ship Same Day!**



FREE Catalog!

2015 BEER CAN SERIES

continued from page 22

STOCKTON SAILING CLUB

Every Wednesday Night: 6/3-8/26.
Tom Lueck, (209) 604-1300,
stknbmixer@aol.com, www.stocktonsc.org

TAHOE YACHT CLUB

Laser Series, Every Monday Night: 5/25-8/24.
Rick Raduziner, (530) 581-4700, raduziner@sbcglobal.net
Beer Can Series, Every Wednesday Night: 5/27-8/26.
Dan Hauserman, (530) 581-4700, dan@ilovetahoe.com
www.tahoeyc.com

TIBURON YACHT CLUB

Every Friday Night: 5/22-9/4.
Ian Matthew, (415) 883-6339,
race@tyc.org, www.tyc.org

VALLEJO YACHT CLUB

Every Wednesday Night: 4/1-9/30.
Dave Nadolne, (925) 580-1499,
fleetcaptainsail@vyc.org,
www.vyc.org

Boomkicker® Boom Supports

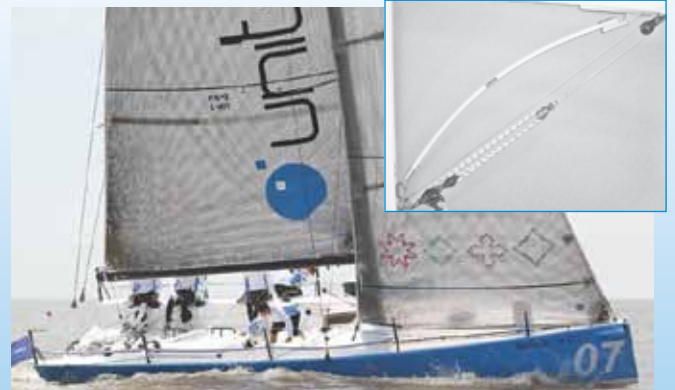

- The simple choice for boats 14 to 38 feet.
- Eliminates the need for the topping lift along with the chafe, windage, hang-ups and adjustment.
- Simple flexing design is lightweight and fast acting with easy installation separate from the vang, fittings included.
- Proven durable and reliable since 1997.
- Simple flexing design (up or down) is lightweight and fast acting.

Join Thousands of Happy Customers!

www.boomkicker.com
(800) 437-7654 • (708) 482-8801

Manufactured in the U.S. by Seoladair Ltd.

Built in the U.S.A.

Craftsmanship to the extent of artisanship goes into every Melges boat. Combine excellence in technique with innovative design, modern production methods, high quality materials, years of experience and tenure, and what have you got? A work of art. A champion. A solid investment with an immeasurable return on fun.

AUDI MELGES 20



Photo by Billy Black Photography

EXPERIENCE

PREMIUM PERFORMANCE

Strongly **SUPPORTED WORLDWIDE**, across the U.S.A., throughout Europe, Australia and Asia, Melges builds and proudly delivers **PREMIUM PERFORMANCE** sportboats and scows. Our passion for the sport of sailing is fostered through simple, fun and competitive **WORLD CLASS RACING**, attracting the best sailors at some of yachtings most celebrated venues. Our **EXCEPTIONAL CUSTOMER SERVICE AND PRODUCT SUPPORT** is unparalleled. When you purchase a Melges boat, you're already a winner.

MELGES
WE ARE SAILING

(262) 275-1110 * MELGES.COM

Melges 32 * Melges 24 * Audi Melges 20 * Melges 17 * A Scow * E Scow * C Scow * MC Scow * X Boat

REICHEL PUGH
YACHT DESIGN

2015 MIDWINTER SERIES

If your organization has a midwinter series you'd like included here next year, email your schedule and contact information to colleen@latitude38.com, or fax it to (415) 383-5816, by November 12, 2015.

BAY VIEW BOAT CLUB

Midwinter Madness. Second Saturday, October-March.
Remaining 2014-2015 season: 1/10, 2/14, 3/14.
Terry Mahoney, (408) 210-0517, tmahoney22@gmail.com
bayviewracing@sbcglobal.net, www.bayviewboatclub.org

BERKELEY YACHT CLUB

Midwinters, remaining 2014-2015 season: 1/10, 1/11, 2/14, 2/15.
Champion of Champions: 3/1.
Fall 2015 dates: 11/14, 11/15, 12/12, 12/13.
Bobbi Tosse, (925) 939-9885, bobbi_john@jfcbat.com
Chowder Series, remaining 2014-15 season: 1/4, 1/8, 1/25, 2/1, 2/8, 2/22, 3/1, 3/8, 3/15, 3/22, 3/29. Fall 2015 dates: 10/4, 10/11, 10/18, 10/25, 11/1, 11/8, 11/22, 11/29, 12/6, 12/20, 12/27.
Paul Kamen, (510) 540-7968, pk@well.com, www.berkeleyyc.org

CORINTHIAN YACHT CLUB

Midwinters: 1/17-18, 2/21 (Rob Moore Memorial Regatta), 2/22.
Jim Erskine, (415) 847-2460, racing@cyc.org, www.cyc.org

ELKHORN YACHT CLUB

Frostbite Series: 2/28, 3/14, 3/28, 4/11, 4/25
Chowder Cup Series: 10/10, 10/24, 11/7, 11/21, 12/5.
(831) 724-3875, eyc@elkhornyc.com, www.elkhornyc.com

ENCINAL YACHT CLUB

Jack Frost Midwinters, remaining 2014-2015 season: 1/10, 2/21, 3/14. Fall 2015: 11/14.
Doug Perry, (510) 867-8064, svchoices@att.net
www.encinal.org

GOLDEN GATE YACHT CLUB

Manuel Fagundes Seaweed Soup Cup, remaining 2014-2015 season: 1/3, 2/7, 3/7. Fall 2015: 11/7, 12/5.
Dennis Bush, (510) 703-5779, bush.sailing@gmail.com, www.ggyc.org

ISLAND YACHT CLUB

Midwinters, remaining 2014-2015 season: 1/11, 2/8, 3/8.
Fall 2015: 11/8, 12/13. John New, (510) 521-2980, iycracing@yahoo.com, www.iyc.org

LAKE MERRITT SAILING CLUB

Robinson Midwinters: Four races, December-March.
Remaining 2014-2015 season: 1/11, 2/14, 3/8.
Mark Marlett, (925) 245-0287

MONTEREY PENINSULA YACHT CLUB

Perry Cup/Midwinters, remaining 2014-2015 season: 1/3, 2/7.
Fall 2015: 11/7-8, 12/5.
John Feeley, race@mpyc.org, www.mpyc.org

Congratulations Karl & Gilles!

PACIFIC CUP 2014



1st Place: PHRF
&
Doublehanded IWI

HOGIN SAILS

✕ 1801D Clement Avenue, Alameda ✕ (510) 523-4833 ✕

2015 MIDWINTER SERIES

OAKLAND YACHT CLUB

Sunday Brunch Series: 1/4, 1/8, 2/1, 2/15, 3/1.
Jim Hild, (510) 277-4676,
oyracecom@gmail.com, www.oaklandyachtclub.com

REGATTA PRO

Winter One Design Series, remaining 2014-2015 season:
1/10, 2/14. Fall 2015: 11/7, 12/12.
Jeff Zarwell, (415) 595-8364,
jzarwell@regattapro.com, info@regattapro.com
www.regattapro.com

RICHMOND YACHT CLUB

Opti Midwinters, remaining 2014-2015 season: 1/31, 2/28.
Fall 2015: 12/5. Dan Brandt, dan.higherfastervmg@gmail.com,
www.richmondyc.org
Midwinters, remaining 2014-2015 season: 1/4, 2/1, 3/1.
Fall 2015: 12/6.
Nancy Pettengill, nancyepettengill@comcast.net,
www.richmondyc.org

SANTA CRUZ YACHT CLUB

Midwinters, remaining 2014-2015 season: 1/17, 2/21, 3/21.
Fall 2015: 11/21, 12/19.
scyc@scyc.org, www.scyc.org

SANTA ROSA SAILING CLUB

Spring Lake Winter Series, remaining 2014-2015 season:
1/24, 2/21, 3/21. www.santarosasailingclub.org

SAUSALITO YACHT CLUB

Midwinters, remaining 2014-2015 season: 1/4, 2/1, 3/1.
Fall 2015: 11/1, 12/6.
Chuck Cihak, race@sausalitoyachtclub.org,
www.sausalitoyc.org

SEQUOIA YACHT CLUB

Redwood Cup, remaining 2014-2015 season: 1/10, 2/21, 3/7.
Fall 2015: 11/21, 12/12.
Winter Series, remaining 2014-2015 season: 1/3, 2/7, 3/14
(St. Patrick's Day Race). Fall 2015: 11/7, 12/15. Rick Dalton,
(650) 255-5766, sviowa@gmail.com, www.sequoiayc.org

SOUTH BEACH YACHT CLUB

Island Fever Series, remaining 2014-2015 season:
1/17, 2/21, 3/21. Fall 2015: 11/21, 12/19. Gerard Sheridan,
(415) 495-2295, rearcommodore@southbeachyachtclub.org,
www.southbeachyachtclub.org

TIBURON YACHT CLUB

Midwinters: 1/10, 2/7, 3/7.
Ian Matthew, (415) 883-6339, race@tyc.org, www.tyc.org

VALLEJO YACHT CLUB

Tiny Robbins Midwinters: three Saturdays, remaining 2014-2015
season: 1/3, 2/7, 3/7. Dave Nadolne, (925) 580-1499,
fleetcaptainsail@vyc.org, www.vyc.org

AIRX
SPINNAKER FABRICS

OCEAN 
PREMIUM *plus*

PLASTIMO

YALE CORDAGE

 **allen**
DESIGNED FOR SAILING

The Best in Top
Quality Marine
Products.
Since 1917.



BAINBRIDGE
INTERNATIONAL
www.bainbridgeintcatalogs.com

15242 Transistor Lane
Huntington Beach, CA 92649
Tel: (800) 433-0101

2015 RACE DECK SCHEDULE

44th Annual Manuel Fagundes

SEAWEED SOUP REGATTA

January 3, February 7
March 7

FRIDAY NIGHT BEER CAN SERIES

May 8, May 22
June 15, June 19
July 3, July 17, July 31
August 14, August 28

45th Annual Manuel Fagundes

SEAWEED SOUP REGATTA

November 7, December 5

**Join us for these fun-filled races,
and enjoy the greatest view at
the friendliest club on the Bay!**

GOLDEN GATE YACHT CLUB

1 Yacht Road, San Francisco, CA 94123
(415) 346-2628
www.ggyc.org

2015 SHORTHANDED CIRCUIT

The OYRA Series and YRA Weekend Regattas all have Shorthanded Divisions. Go to www.yra.org for details. Sequoia YC has a shorthanded series for local racers. The Singlehanded Sailing Society hosts seven local races and the Singlehanded TransPac in even years.

Jan. 31	Three Bridge Fiasco, SSS
Feb. 28	Single/Doublehanded #1, SeqYC
March 14	Rites of Spring Race, OYC
March 28	Doublehanded Farallones, BAMA
March 28	Corinthian Race, SSS
April 1	Doublehanded Lightship Race, IYC
April 1	Long Distance #1, SSC
April 17	Doublehanded Long Distance, SSC
April 18	Round the Rocks, SSS
April 25	YRA OYRA #1 Lightship
May 2-3	YRA Great Vallejo Race
May 9	Single/Doublehanded #2, SeqYC
May 9	YRA OYRA #2 Farallones Race
May 9	Long Distance #2, SSC
May 22	Spinnaker Cup to Monterey, SFYC/MPYC
May 23	Singlehanded Farallones Race, SSS
June 6	YRA OYRA #3 Duxship
June 13	Jack and Jill Race, SSC
June 25	Single/Doublehanded #3, SeqYC
June 27	YRA OYRA #4 Half Moon Bay Race
July 11	Jill and Jack, SSC
July 18	YRA Westpoint Regatta
July 25	YRA OYRA #5 Jr. Waterhouse
July 26	Doublehanded Races, LTWYC
Aug. 1-2	YRA Second Half Opener
Aug. 16	Singlehanded Race, LTWYC
Aug. 22	Single/Doublehanded #4, SeqYC
Aug. 22-23	YRA OYRA / SSS Drake's Bay Race
Aug. 23	Gracie & George Race, EYC
Sept. 12	Single/Doublehanded #5, SeqYC
Sept. 19	Half Moon Bay Race, SSS
Sept. 19	YRA OYRA Race #8
Sept. 20	Jack and Jill Regatta, SCYC
Sept. 26-27	YRA Season Closer
Oct. 3	YRA OYRA Race #9
Oct. 3	Shorthanded Races, TYC
Oct. 17-18	Vallejo 1-2, SSS
Nov. 1	Jack & Jill + 1 Race (Triplehanded), IYC

Use the Autopilot Favored by Singlehanded Racers

**For over 40 Years, ALPHA PILOTS
Have Delivered the Highest Performance,
Reliability and Low Power Consumption
These Competitors Demand!**



Photo by Robbie Gabriel

Overall Winner 2012 Singlehanded TransPac

Jim Quanci, after placing 1st Overall in the 2012 Singlehanded TransPac in his Cal 40 *Green Buffalo* says:

"13 days from San Francisco to Hawaii alone, 10 of those days flying the spinnaker in winds up to 32 knots without a round up or a wrap. My Alpha Spectra autopilot drove the whole way – and then drove the boat another 16 days taking us home. What more can one ask for? I just love my Alpha Spectra autopilot."

Why buy an Alpha Autopilot? We'll make your boating more fun!

A WORLD CLASS PRODUCT PROUDLY BUILT IN THE USA

ALPHA MARINE SYSTEMS, INC., 6809 96th Avenue SE, Mercer Island, WA 98040 • (800) 257-4225 (206) 275-1200
email sales@alphamarinesystems.com Visit our website www.alphamarinesystems.com

**TRANSPAC
2015**

Downwind to Paradise.....

*The Greatest Race
Across the Pacific.*

First Start.....Monday, July 13, 2015
Second Start.....Thursday, July 16, 2015
Third Start.....Saturday, July 18, 2015

*Notice of Race and Full Entry Information
available now at www.TranspacYC.com*

*Contact Entry Chair Ross Pearlman at:
TranspacEntry2015@TranspacRace.com*

Aloha!

Photo: Sharon Green@Ultimate Sailing

2015 FLEET SCHEDULES

Sailing Instructions for all YRA regattas and races are posted on www.yra.org, the YRA website. Sailing Instructions are available one week prior to the start of each race.

Racers entering an ocean race or an ocean series must comply with the specific OYRA Minimum Equipment Requirements, including the requirement for a 406 EPIRB or PLB. No later than the Thursday before EACH race, sailors must complete the online Crew & Boat registration form through www.jibeset.net. Please refer to www.yra.org/OYRA/ocean_safety.html for more information on ocean racing requirements.



DIMENSION-POLYANT
The Sailcloth Producer

IN-HOUSE MANUFACTURING In Germany and USA
QUALITY AND INNOVATION Continuous research and adherence to the highest standards
RELIABILITY World-wide, Sailors and Sailmakers trust in DIMENSION-POLYANT

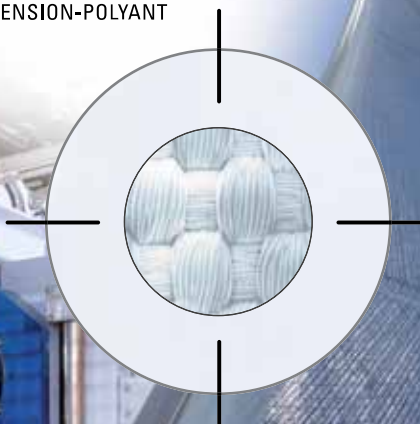

DIMENSION-POLYANT Inc. • 78 Highland Drive • USA-Putnam CT 06260 • T +1 (860) 928 6300 • info@us.dimension-polyant.com

Single Race Entries are due by 5:00 p.m. the Monday prior to the race. Entries received after 5:00 p.m. Monday may incur a \$35 late fee. Entries are not accepted after 5:00 p.m. the Thursday prior to the race.

YRA Spring Series

For PHRF, Sport Boat and One Design. Notices of Race for all YRA Series can be found on the YRA website: www.yra.org.

- April 18: YRA Spring Series #1
- May 16: YRA Spring Series #2
- June 13: YRA Spring Series #3

YRA Summer Series

Notices of Race for all YRA Series can be found on the YRA website: www.yra.org.

- July 11: YRA Summer Series #1
- August 8: YRA Summer Series #2
- September 12: YRA Summer Series #3

OYRA Series

Notices of Race for all YRA Series can be found on the YRA website: www.yra.org.

- April 25: OYRA #1 Lightship
- May 9: OYRA #2 Farallones
- June 6: OYRA #3 Duxship
- June 27: OYRA #4 Half Moon Bay

continued on page 32

One Design Racing on San Francisco Bay

The Bay Area's active one design fleets welcome you to a new season of racing. Among these fleets, there's a boat that fits every skill, schedule or budget.

Are you still wondering if your fleet finish position was because of your PHRF rating or in spite of it? Come join a one design fleet and enjoy level racing where your finish is where you place, how well you sail is how well you do.

Contact the fleet captain for the class of your choice to discuss joining a fleet, buying a boat or learning more about One Design Racing season.

Sign up and join us on the water in 2015!

JOIN US

36

Islander 36 Fleet Association

*Fun racing, comfortable cruising,
friendly fleet, great website.*

Spring Meeting, March 21, Golden Gate YC

Curious? Visit: www.islander36.org

Racer? Fleet Captain Kit Wiegman (510) 522-9800

Questions? Commodore Rick Van Mell (650) 962-1515

SANTANA 22

JOIN US FOR
THE 2015
S22 NATIONALS
July 17-19
Corinthian YC



www.santana22.com

- ◆ Tight, tactical one design racing
- ◆ Mentor program for new members
- ◆ New boats now in production, but old boats just as fast
- ◆ Non-spinnaker and spinnaker races, cruise-ins and parties
- ◆ The best bang for the buck on the Bay!

co-fleet captains Anna Alderkamp & Garth Copenhaver
(415) 450-0843 • Santana22sfbay@gmail.com

Express 37



One of Carl Schumacher's breakthrough designs, the Express 37 has been one of the most successful one design fleets on the Bay for over 25 years.

Contact:
Dave Fullerton
(650) 458-3324
www.express37.net

Join us for our
**29TH NATIONAL
CHAMPIONSHIP
REGATTA**
and the Rolex Big
Boat Series

2015 FLEET SCHEDULES

continued from page 30

OYRA Series (cont'd)

Notices of Race for all YRA Series can be found on the YRA website: www.yra.org.

July 25: OYRA #5
August 22: OYRA #6
August 23: OYRA #7
September 19: OYRA #8
October 3: OYRA #9

YRA-WBRA Series

Notices of Race for all YRA Series can be found on the YRA website: www.yra.org.

April 19: WBRA #1
May 2: WBRA #2
May 16: WBRA #3
August 1: WBRA #4
August 15: WBRA #5
September 26: WBRA #6

YRA WEEKEND REGATTAS

Notices of Race for all YRA Series can be found on the YRA website: www.yra.org.

May 2-3: Season Opener
The Great Vallejo Race
July 18: Westpoint Regatta
August 1-2: Second Half Opener
September 26-27: Season Closer

SSS

See ad on page 77.

January 31: Three Bridge Fiasco
March 28: Corinthian Race
April 18: Round the Rocks
May 23: Singlehanded Farallones
July 9: LongPac
August 22-23: Drake's Bay Race
September 19: Half Moon Bay Race
October 17-18: Vallejo 1-2

CHRIS BOOME INSURANCE AGENCY

800-853-6504
San Francisco Bay



MARINE INSURANCE SPECIALIST WITH
ACCESS TO ALL MAJOR CARRIERS

IF YOU OWN A BOAT OR CAR YOU NEED A
PERSONAL UMBRELLA POLICY

IF YOU ARE GOING TO MEXICO IN YOUR BOAT OR
CAR YOU NEED MEXICAN LIABILITY INSURANCE

Here's what our customers have to say:

"I have been dealing with Chris Boome for over five years and 25,000 miles of coastal and ocean sailing. The service that Chris delivers allows me to sail with confidence knowing that I am fully covered wherever my sailing adventures take me. Chris being a sailor himself fully understands my requirements and has proven that he can provide a very competitively priced insurance policy."

– Rob Andrews, Swan 53 *Mistress*, Pacific Northwest

"Chris has precisely the qualities that a boat owner should be looking for in an insurance agent – he's responsive, efficient, and, most important, an ally when things go pear-shaped. Insurance protection has to be right for what you need and be there when you need it. Stuff happens with boats, and when it did for us, Chris was right there to make sure that it turned out well."

– Tim Knowles, Wyliecat 39 *Lilith*, San Francisco Bay

"Chris Boome has consistently delivered the insurance we need for the past six years. Despite the complex needs of a voyaging yacht with changing plans, Chris always delivered a solution. Working with Chris has always been a pleasure and his office has always been very efficient and provided added value."

– Herb Hunt, Custom Farr 50 P.H. *Wandering Farr*, Caribbean

"We have been using Chris Boome for insurance on *Golden Moon* for 13 years. Chris is knowledgeable and fair, and responds promptly to our needs. He is an expert sailor and brings great knowledge to all discussions on sailing. I recommend him whole heartedly."

– Kame Richards, Express 37 *Golden Moon*, San Francisco Bay

Call Chris 650-373-0595 • 650-464-0728 cell

Boomeins@aol.com

www.chrisboome.com

License: OA99058

Put the smooth back in sailing

SAILKOTE™

HIGH-PERFORMANCE DRY LUBRICANT

Use on sliding hatches, sail tracks, sails, battens, telltales, slider cars and more

- Repels water, dirt, salt, and contaminants
- Reduces drag and increases efficiency
- Clean, dry, and easy-to-use

ANTIFOUL ALTERNATIVE

ENVIRONMENTALLY FRIENDLY ANTIFOUL POLISH

Use on hulls, outrives, and propellers

- Helps prevent below-the-waterline marine growth and slime from adhering for weeks
- Reduces drag and increases efficiency
- Biodegradable, non-metallic, non-leaching

HULLKOTE™

HIGH-PERFORMANCE SPEED POLISH

Use on fiberglass, metal, plexiglass, and painted surfaces

- High-gloss finish that cleans, polishes, and protects
- Reduces drag and repels water
- Superior UV protection

ONEDROP™

BALL BEARING CONDITIONER

Use on ball bearing traveler cars and battcars

- Repels salt, dirt, and other deposits
- Reduces friction so balls roll freely and evenly
- Only one drop needed



For Everything That Slides



For Everything Below the Waterline



For Everything That Shines



For Everything That Rolls

With these products from Team McLube™

Team McLube™

Learn more at: WWW.MCLUBEMARINE.COM



Established 1912

SAUSALITO YACHT CLUB

2015 RACE SCHEDULE

SYC offers excellent racing off the scenic Marin Headlands adjacent to the iconic Golden Gate Bridge. The warm club atmosphere provides a great location for after race bragging or complaining. The bar and galley are open after all the races.



www.sausalitoyachtclub.org/racing

- SYC Chili Midwinter Series: The first Sunday of the month – January 4, February 1, March 1, November 1, December 6.
- Jaws – March 21: A single pursuit race with the start and finish near Sausalito Yacht Club, recalling a club tradition of starts and finishes off the club deck, with the new "Jaws" trophy. A "Predicted Log" race for power boats will be running concurrently with this race for sailboats.
- Twin Island Series: Three races around Alcatraz and Angel Island on April 25, July 18 and October 17. (You choose your direction around the islands... Course B possibility of Angel Island and Red Rock Island.)
- Sunset Series: Ten spring and summer races on alternate Tuesday nights to set aside work pressures for mid-week competition. The Spring Series starts April 28 and the Summer Series starts July 21 and runs through September. The Sunset Champion of Champions Race is September 29.
- Women Skippers Race: A race on May 16 with a woman as skipper. "No man may touch the wheel!"
- Rear Commodore's Race: A 20-mile race/cruise to Vallejo Yacht Club on June 27. This is usually a great downwind race with an excellent party and dinner afterward.
- High School Invitational Regatta: October 3.

WOMEN'S CIRCUIT

Sunday, February 22

Sadie Hawkins Race, IYC
John New, (510) 521-2980, iyrcracing@iyc.org,
www.iyc.org

Saturday, March 14

Rites of Spring (division for all-female crews), OYC
Jim Hild, (510) 277-4676, oycracecom@gmail.com,
www.oaklandyachtclub.com

Saturday, May 16

Women Skippers Race, SYC
Chuck Cihak, race@sausalitoyachtclub.org,
www.sausalitoyachtclub.org

Lady and the Tramp Race, FLYC
www.flyc.org

Saturday, July 11

Jack and Jill Race, SSC
Tom Lueck, (209) 604-1300,
www.stocktonsc.org

Saturday, July 25

Sadie Hawkins, KBSC
Brad King, chezking@att.net,
www.kbsail.com

Saturday, August 1

Kay & Dave Few Regatta, CPYC
(650) 347-6730, regatta@cpyc.com,
www.cpyc.com

Sunday, August 9

Ladies' Day Races, LTWYC – South Lake Tahoe
Kurt Rasmussen, (530) 307-0903,
ltwyc2@aol.com
www.tahoewindjammers.com

Sunday, August 23

Gracie & George Regatta, EYC
Doug Perry, (510) 867-8064, svchoices@att.net,
www.encinal.org

Saturday & Sunday, September 19-20

Women's Sailing Seminar
(race Sunday), IYC
John New, (510) 521-2980, iyrcracing@iyc.org,
www.iyc.org

Sunday, September 20

Jack and Jill Regatta, SCYC
cyc@scyc.org, www.scyc.org

QUALITY, INNOVATION, PERFORMANCE WORLD CLASS YACHTING ROPES



WR2
Synthetic
Lifelines



HSR
Stronger Than
Steel Fiber Rope

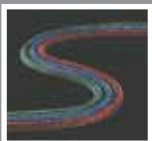

Poly Tec
Aramid Polyester
Cover with
Dyneema Core



**Spinnaker
Furling Line**
Anti-torsion
Furling Cable



NEW ENGLAND ROPES

TOGETHER IN MOTION

TEUFELBERGER FIBER ROPE CORP. 848 Airport Road, Fall River, MA 02720 T: 800-333-6679, www.neropes.com

WOMEN'S CIRCUIT

Sunday, September 27

Jack & Jill, KBSC
Brad King, chezking@att.net,
www.kbsail.com

Saturday, October 3

Red Bra Regatta, SBYC
Gerard Sheridan, (415) 495-2295
rearcommodore@southbeachyachtclub.org,
www.southbeachyachtclub.org

Saturday, October 17

Joan Storer Regatta, TYC
Ian Matthew, (415) 883-6339, race@tyc.org,
www.tyc.org

Sunday, October 18

Ladies Skippers Regatta, PresYC
Anne Springer, (415) 331-5335,
www.presidoyachtclub.org

Sunday, November 1

Jack & Jill + 1
(woman skipper triplehanded race), IYC
John New, (510) 521-7442,
iycracing@iyc.org,
www.iyc.org

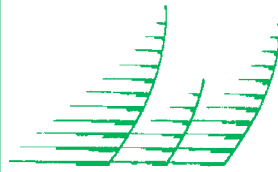

Westwind

Washing, Waxing, Varnishing
and Interior Cleaning

"The boat looks great. It really is a pleasure to come back to a clean boat. Your service is fantastic."



*- David Enzminger,
Hunter 35
'Meerhexe'*



(415) 661-2205

Pier 40, South Beach on the Embarcadero • San Francisco

Call Toll Free

888-828-6789

westwinddetailing@sonic.net

www.boatdetailing.com

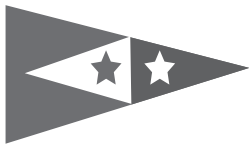

Back by Popular Demand!

Midnight Moonlight Maritime Marathon

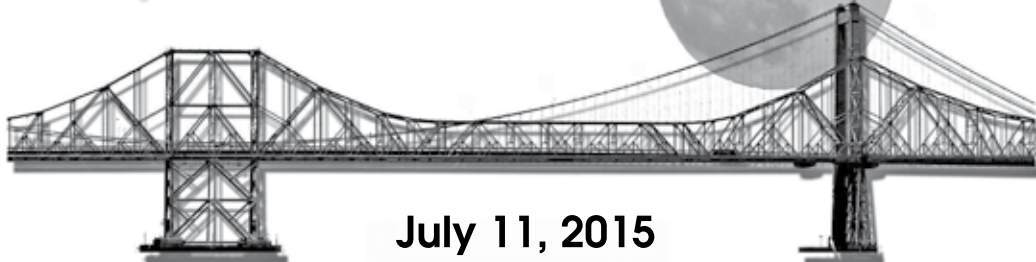

July 11, 2015

One of the most fun races on the Bay since the 1950s!

Bring your family and friends, pack a picnic dinner, and enjoy this ~35 mile pursuit race from Pt. Stuart to the Carquinez Bridge and return to finish under the light of the moon in Racoon Strait.

For more details and to register, visit:

www.SFYC.org > On the Water > Racing > Schedule

BRITISH VIRGIN ISLANDS

March 30 to April 5

**Warm Water
Hot Racing
Cool Parties**

**The BVI Spring Regatta
& Sailing Festival**

**3 Race Areas
3 Race Committees
3 Bodies of Water
18 Classes**

More Racing



Hosted by



2015
**BVI Spring
Regatta**
& sailing festival

bvispringregatta.org

2015 CARIBBEAN CIRCUIT

MOUNT GAY ROUND BARBADOS RACE SERIES

January 16-24 • Barbados

www.mountgayroundbarbadosrace.com

SUPERYACHT CHALLENGE ANTIGUA

January 29-February 1 • Antigua

www.thesuperyachtchallenge.com

GRENADA SAILING FESTIVAL

January 29-February 3 • Grenada

(473) 534-6731 or (473) 456-0914

www.grenadasailingfestival.com

RORC CARIBBEAN 600

February 23

(721) 544-2079, www.caribbean600.rorc.org

ST. MAARTEN HEINEKEN REGATTA

March 5-8 • St. Maarten

(721) 544-2079, www.heinekenregatta.com

LORO PIANA CARIBBEAN SUPERYACHT REGATTA

March 11-14 • BVI

www.loropianasuperyachtregattaandrendezvous.com

ST. BARTHS BUCKET REGATTA

March 19-22 • St. Barths, FWI

(781) 639-0203, www.bucketregattas.com

ST. THOMAS INTERNATIONAL REGATTA

March 27-29 • St. Thomas, USVI

(340) 775-6320, www.rolexcupregatta.com

BVI SPRING REGATTA AND SAILING FESTIVAL

March 30-April 5 • BVI

(284) 541-6732, www.bvispringregatta.org

BEQUIA HEINEKEN EASTER REGATTA

April 2-6 • Bequia

(784) 457-3649, www.begos.com/easterregatta

LES VOILES DE SAINT BARTH

April 13-18 • St. Barths, FWI

(590) 27 20 64, www.lesvoilesdesaintbarth.com

ANTIGUA CLASSICS REGATTA

April 16-21 • Antigua Yacht Club

Ph/Fax (268) 460-1799, www.antiguaclassics.com

ANTIGUA SAILING WEEK

April 25-May 1

(268) 460-1799, www.sailingweek.com

ST. BARTH WEST INDIES REGATTA

April 30-May 3 • St. Barth

www.westindiesregatta.com

FOXY'S WOODEN BOAT REGATTA

May 2015 • Jost Van Dyke, BVI

<http://foxysbar.com/woodenboatregatta>

PUERTO RICO HEINEKEN INTERNATIONAL REGATTA

May 22-24 • Puerto Rico

(787) 277-5936, www.prheinekenregatta.com

DRY CREEK VINEYARD PRO-AM REGATTA

October 24-31 • Bitter End Yacht Club, BVI

(800) 872-2392, www.beyc.com

RACE THE WORLD WITH SUNSAIL



Here at Sunsail we're ready to send some charterers home with a trophy or two. Our 2015 Regatta season is about to kick off in the Caribbean and we are prepared with the most competitive global bareboat fleet to charter.

From the BVI Spring Regatta to the UK's famous Cowes Week, we'll provide all you need to take line honors at the most iconic and exotic regattas the globe has to offer.

CARIBBEAN:

Grenada Sailing Week	January 29 - February 3
Heineken Regatta	March 5 - 8
St. Thomas International Regatta	March 27 - 29
BVI Spring Regatta	March 30 - April 5
Antigua Sailing Week	April 25 - May 1

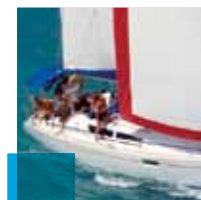

PACIFIC:	UK:	
Tahiti Pearl Regatta	Cowes Week	August 8 - 15
Hamilton Island Race Week		
April 29 - May 3		
August 15 - 22		

SEE THE WORLD, DIFFERENTLY.
877-788-0496 WWW.SUNSAIL.COM/YACHT-RACING



2015-2016 PACIFIC OCEAN EVENTS

HAWAII & SOUTH PACIFIC

TAHITI PEARL REGATTA • April 29-May 5, 2015
International fleet racing in the Leeward Islands of Tahiti
www.tahitipearlregatta.org.pf

TRANSPACIFIC YACHT RACE • starts July 13, 2015
Los Angeles to Honolulu, Hawaii
www.transpacrace.com

VIC-MAUI • July 2016
2,300 miles from Victoria, BC, to Maui, Hawaii
www.vicmaui.org

PACIFIC CUP • starts July 11, 2016
San Francisco to Kaneohe Bay, Oahu, Hawaii
www.pacificcup.org



LESLIE RICHTER / WWW.ROCKSKIPPER.COM

MEXICO

BANDERAS BAY REGATTA • March 3-7, 2015
Music, fun, and racing specially designed for cruisers on Banderas Bay
www.banderasbayregatta.com

NEWPORT TO CABO RACE • starts March 20, 2015
Newport Beach to Cabo San Lucas, Baja California Sur
www.nhyccaborace.com

LEXUS NEWPORT TO ENSENADA • April 24-26, 2015
Newport Beach to Ensenada, Baja California
www.newporttoensenada.com

PV RACE • starts February 19, 2016
1,100-mile slide from San Diego to Puerto Vallarta
www.sdyc.org/pv

AUSTRALIA & NEW ZEALAND

BAY OF ISLANDS SAILING WEEK
January 21-23, 2015
Buoy racing in New Zealand's Bay of Islands
www.bayofislandssailingweek.org.nz

AUDI HAMILTON ISLAND RACE WEEK
August 15-22, 2015
Racing and partying in Australia's Whitsunday Islands
www.hamiltonislandraceweek.com.au

COASTAL CLASSIC AUCKLAND TO RUSSELL YACHT RACE • Late October
Point to point race from Auckland to Russell in New Zealand's Bay of Islands
www.coastalclassic.co.nz

ROLEX SYDNEY HOBART YACHT RACE
December 26, 2015
World's preeminent middle-distance race — 628 miles from Sydney Harbour to the Derwent River, Australia
www.rolexsydneyhobart.com

ASIA

ROYAL LANGKAWI INTERNATIONAL REGATTA
January 12-17, 2015
Large buoy racing regatta for everything from IRC divisions to multihulls
www.langkawiregatta.com

SUBIC BAY TO BORACAY RACE • Feb. 27-March 2, 2015
200-mile race from Subic Bay to Boracay, Philippines
www.subicsailing.com

BORACAY CUP REGATTA • March 3-6, 2015
Following the offshore Race from Subic Bay, the Boracay Cup gets underway with two days each of windward/leeward courses and round-the-island courses.
www.subicsailing.com

CHINA CUP INTERNATIONAL REGATTA
October 24-27, 2015
The world's newest and most ambitious yachting festival, held in the southern city of Shenzhen
www.chncup.com

PHUKET KING'S CUP • Late November–Early December
Five days of racing at Thailand's biggest event
www.kingscup.com

ROLEX CHINA SEA RACE • March 23, 2016
565-mile race from Hong Kong to Subic Bay, Philippines
www.rhkyk.org.hk/rolexchinasearace.aspx

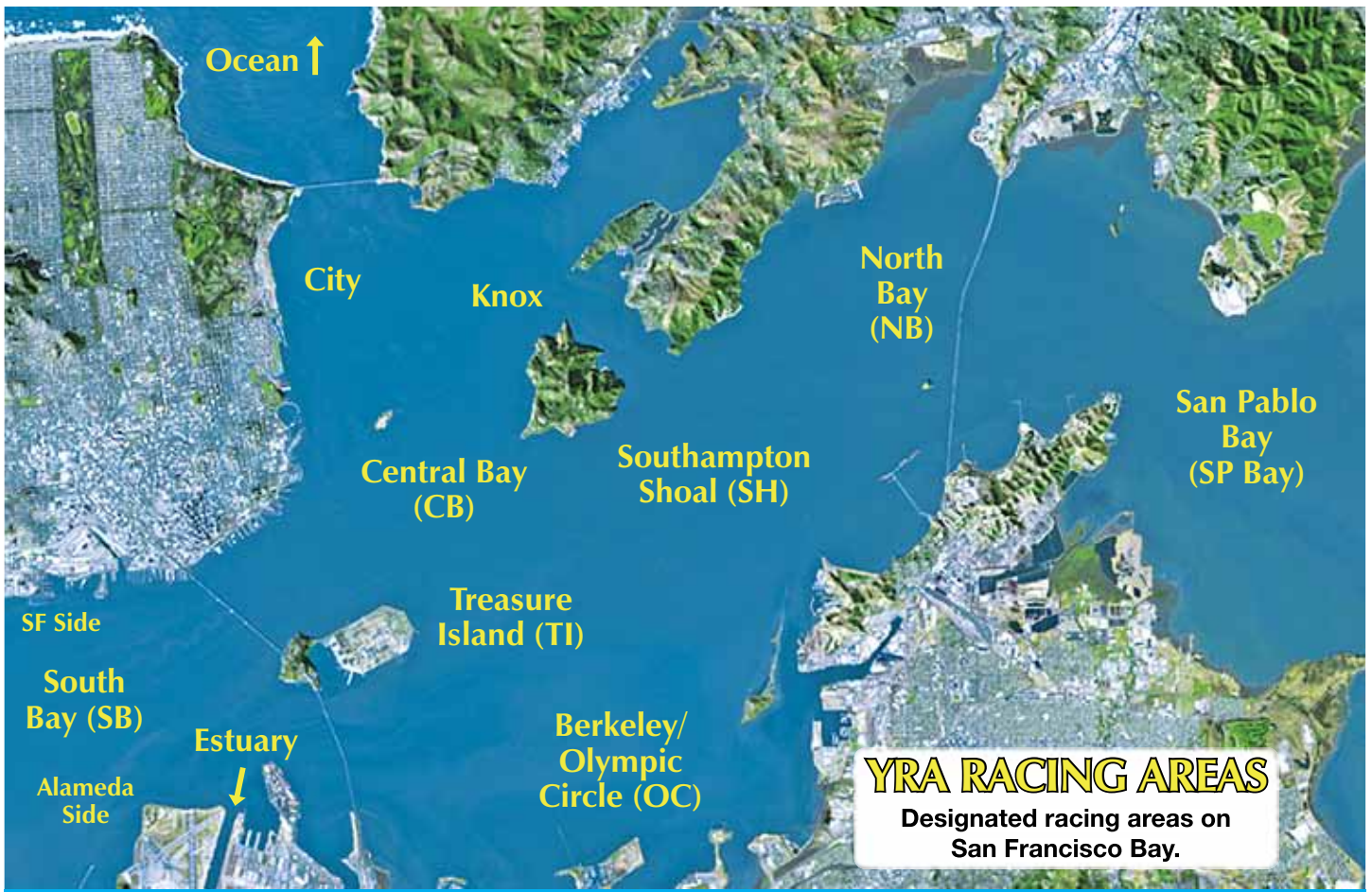

YRA RACING AREAS
 Designated racing areas on San Francisco Bay.

California Condor • Built at Berkeley Marine Center

Think Fast!

Fast Bottoms and Fast Boats made to order



Berkeley Marine Center

The yard that works for you!

In Berkeley Marina
 510-843-8195
www.berkeleymarine.com

ISLAND YACHT CLUB

Located adjacent to Svendsen's Marine
in the Alameda Marina
1853 Clement Avenue, Building 14

2015 RACING SCHEDULE

1/11, 2/8, 3/8: Estuary Midwinters Island Days

Feb 22: **Sadie Hawkins** Woman-Skippered Race on the Estuary, Full Crew

Apr 11: **34th Annual Doublehanded Lightship** Proceeds Benefit United Cerebral Palsy



CHRISTINE WEAVER

Apr-Sept: **Spring & Summer Twilight Series**
Friday evening beer can racing

Apr-Sept: **Interclub Races**

June 27: **Silver Eagle** Long Distance Race, Classic Course and Shortened Course

Sept 19-20: **Northern California Women's Sailing Seminar & Regatta**
'Capture the Power', with flat water Estuary racing on September 20

Nov 1: **Jack & Jill +1** Woman-Skippered Triplehanded Race on the Estuary

Nov 22: **Commodore's Challenge**

Nov '14- **Estuary Midwinters Island Days**
Mar '15: **Second Sundays of each month**

• Sponsor of YRA and OYRA races •
Member of PICYA

For information, see www.iyc.org
racing@iyc.org
phone
(510) 521-2980

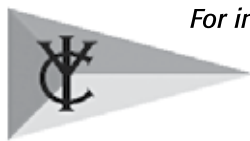

DEFINITIONS FOR YRA RACING AREAS

The following racing areas have been defined by the YRA for the purposes of describing the general geographical location and the marks that may be used in a YRA race. Please refer to the individual Sailing Instructions for each YRA race for the exact courses. Temporary marks may be used instead of, or in conjunction with, the described marks in any of these YRA Racing Areas. Sailing Instructions will be available on the YRA website at www.yra.org approximately one week prior to the start of a YRA race.

BERKELEY CIRCLE (OC) RACING AREA

See pages 44-45.

Includes Marks BOC, COC, DOC, EOC, FOC, GOC, XOC, 8, 12, 15, 17.

CITYFRONT RACING AREA

See pages 44-45.

Includes Marks A, X, 6, 16, 17, 18, 21.

KNOX RACING AREA

See pages 44-45.

Includes Marks K, L, N, 4, 12, 15, 21, 23.

NORTH BAY (NB) RACING AREA

See page 46.

Includes Marks CM2, NG7, NR8, NR10, NR12, NR14, TYC, 14.

SOUTH BAY (SB) ALAMEDA SIDE RACING AREA

See page 42.

Races held in this sailing area will use temporary marks in the vicinity of NAS2.

SOUTH BAY (SB) SAN FRANCISCO SIDE RACING AREA

See page 42.

Includes Marks AS1, NAS2, W1, XS1, 31, 34, 37.

SOUTHAMPTON SHOALS (SH) RACING AREA

See pages 44-45.

Includes Marks N, 7, 12, 14, 19, 21.

TREASURE ISLAND (TI) RACING AREA

See pages 44-45.

Includes Marks EOC, 2, 7, 9, 10, 17, 18, 21.

BayRisk *Classic*



BayRisk

Insurance Brokers, Inc.

800-647-2025

Visit our Website
www.bayrisk.com

1920 Minturn Street
Alameda, CA 94501

POWER YOUR BOAT AT
KKMI – POINT RICHMOND
HANSEN RIGGING – ALAMEDA
PACIFIC OFFSHORE RIGGING – SAN DIEGO

 **ALPHAROPES**[®]
HIGH PERFORMANCE YACHTING ROPES



©2015 Alpha Ropes

SOUTH BAY MARKS



DESCRIPTION OF MARKS

- | | |
|---|--|
| AS1: Yellow Sphere approx. .25 nm east of BVBC | 31: Temporary YC Buoy approx. 1.2 nm SE of Mission Rock Terminal |
| NAS2: NAS Alameda Channel Mark "R2" FI R 4s | 33: Red Buoy "4" FI R 4s, Oakland Inner Harbor Entrance Channel |
| SC1: Red & Green Buoy "SC" FI G (2+1) approx. 1 nm ENE of Mission Rock Terminal | 34: Red Buoy "2" FI R 2s approx. .5 nm east of Potrero Point |
| W1: Temporary YC Buoy approx. 1 nm east of Army St. Terminal | 35: Green Daymarker "3" FI G 2.5s, Alameda NAS Entrance Channel |
| XS1: Temporary YC Buoy approx. halfway between 31 & AS1 | 36: Red Daymarker "4" FI R 4s, Alameda NAS Entrance Channel |
| | 37: Green Buoy "5" FI G 4s approx. 1 nm SSE of Army St. Terminal |

COMBINING A LOVE FOR WINE *with*
A PASSION *for* SAILING.



Dry Creek
VINEYARD

THE OFFICIAL
SINCE 1972

WINE FOR
SAILORS™

“The good folks at Dry Creek are committed to our sport and to making great wine.”

– Peter Isler, two-time America’s Cup winner

POST OFFICE BOX T • 3770 LAMBERT BRIDGE RD • HEALDSBURG, CA 95448 • 707-433-1000 • drycreekvineyard.com • ©2013 Dry Creek Vineyard, Healdsburg, CA



HEAD SOUTH FOR RACING IN 2015

Join Us at the Sequoia Yacht Club

**SEQUOIA YC
CHALLENGE –**
Race your club as a
team in the Barth Race
Sat., Sept. 19



WESTPOINT REGATTA

Saturday, July 18

One of the YRA
Weekend Regattas

MOONLIGHT MARATHON

Saturday, August 29

SOUTH BAY CHAMPIONSHIP

Saturday, October 24

Also join us for these races: Redwood Cup Series • Winter Series • Single/Doublehanded Series • Summer Series
Hannig Cup (Part of Wednesday Night Beer Can Series) • Barth Race • Corkscrew Slough Regatta (El Toro Fleet)

For more information go to: www.sequoiayc.org

CENTRAL BAY MARKS

Brought to you by
Latitude 38's
Latitude 38's 3x/week blog



- Racing Wrap-Ups
- Action Photos
- Racing Previews
- Free Subscription

Sign up
now!



visit
www.latitude38.com

DESCRIPTION OF MARKS

Buoys of Berkeley Circle: BOC, COC, EOC, FOC, GOC, XOC

YRA Mark XOC has been designated the *Bob Klein Memorial Buoy* by the YRA Board of Directors. Maintenance of this buoy is funded by the Richmond Yacht Club Foundation.

A: Yellow Column "A" Outer Buoy ~ St. Francis Yacht Club

D: G "3" Fl G 4s 15 ft on Olympic Circle

K: Temporary YC Buoy .3 nm west of YRA 4 and in line with YRA 12

L: Temporary YC Buoy .31 nm west of windmill in line with YRA 4

N: Daymark "2" Fl R on channel east of Sausalito

X: Yellow/Blue Sphere "X" ~ Golden Gate Yacht Club

1: Red Rock Island

2: Alcatraz Island

3: Farallones Light (ocean)

4: Temporary YC Buoy WSW of Pt. Knox

5: Temporary YC Buoy approx. .6 nm SW of Alcatraz

6: Yellow Column "M" 200 yds. north of Ft. Mason Docks

7: R "2" Fl 6s 1 nm NW of Treasure Island

8: R "4" Fl 4s Horn 1 nm east of Pt. Blunt

9: Temp. YC Buoy .5 nm ESE of west end of Berkeley Pier ruins 1 nm ENE of YRA 10

10: Temporary YC Buoy approx. .6 nm ESE of west end of Berkeley Pier ruins

11: Temporary YC Buoy 1.5 nm east of Treasure Island

12: G "1" Fl G 4s Little Harding Rock

13: Crissy Field Buoy

14: Southampton Shoals





For North Bay marks,
see page 46

For South Bay
marks,
see page 42

- 15: Temporary YC buoy approx. .5 nm east of Yellow Bluff (Sausalito vicinity)
- 16: Yellow Column "C" .2 nm east of Fort Point "Blackaller"
- YRA Mark 16 has been designated the *Thomas D. Blackaller Jr. Memorial Buoy* by the YRA Board of Directors. The maintenance of this buoy will be funded by the Thomas D. Blackaller Jr. Fund.
- 17: RG "HR" FI (2+1) R 6s, Harding Rock
- 18: RG "BR" FI (2+1) G 6s Bell, Blossom Rock
- 19: R "8" FI R 2.5s approx. 1.5 nm east of Pt. Bluff
- 21: G "1" FI G 6s .65 nm NE of Alcatraz
- 23: RW "A" Mo (A) east of Angel Island
- 24: R "6" FI R 4s Bell, 1.1 nm east of Quarry Pt.
- BYC: Yellow Column "BYC" east of COC
- CM2: R "2" FI R 6s on outer end of Corte Madera Channel
- NO: North Approach Buoy FI Y 4s to San Francisco Channel (ocean)
- SO: South Approach Buoy FI Y 4s to San Francisco Channel (ocean)
- NBAY: Temporary YC Buoy approx. .6 nm NE of Tiburon YC clubhouse
- NG7: G "7" FI G 2.5s approx. .45 nm SE of Red Rock
- NR12: R "12" FI R4s approx. 1.3 nm south of Richmond-SR Bridge main channel
- NR14: R "14" FI R4s approx. .28 nm south of Richmond-SR Bridge main channel
- PB: Point Bonita RG FI (2+1) R 6s bell (ocean)
- RYC: Yellow Column "RYC" on southern edge of Southampton Shoals
- SF: Center Channel Buoy RW "SF", strobe FI 2.5s whistle on SF Channel (ocean)
- TYC: Privately maintained white mark "TYC" off south entrance to Paradise Cay

NORTH BAY MARKS

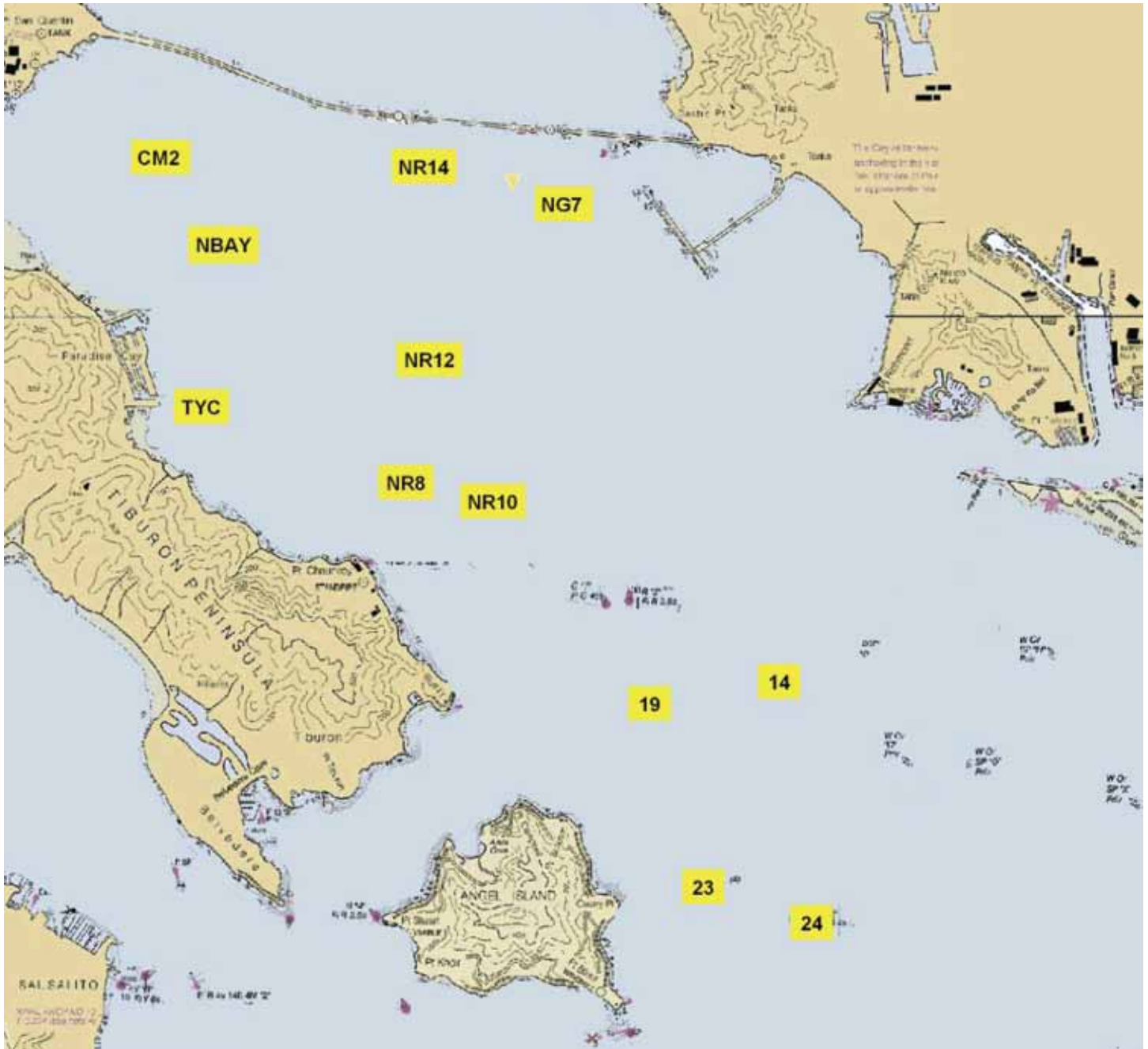

DESCRIPTION OF MARKS

- 14: Southampton Shoals
- 19: R "8" Fl R 2.5s approx. 1.5 nm east of Pt. Bluff
- 23: RW "A" Mo (A) east of Angel Island
- 24: R "6" Fl R 4s Bell, 1.1 nm east of Quarry Pt.
- CM2: R "2" Fl R 6s on outer end of Corte Madera Channel
- NO: North Approach Buoy Fl Y 4s to San Francisco Channel (ocean)
- SO: South Approach Buoy Fl Y 4s to San Francisco Channel (ocean)
- NBAY: Temp YC Buoy approx. .6 nm NE of Tiburon YC clubhouse
- NG7: G "7" Fl G 2.5s approx. .45 nm SE of Red Rock
- NR12: R "12" Fl R 4s approx. 1.3 nm south of Richmond-San Rafael Bridge main channel
- NR14: R "14" Fl R 4s approx. .28 nm south of Richmond-San Rafael Bridge main channel
- SF: Center Channel Buoy RW "SF", strobe Fl R 2.5s whistle, on San Francisco Channel (ocean)
- TYC: Privately maintained white mark "TYC" off south entrance to Paradise Cay



CAROLE GUNN

RULES

Latitude 38's Basic Racing Guidelines

Since sailboat racing is a recreational sport, we think the number one rule should be to have fun. Beyond that, some basic guidelines help prevent collisions and ensure that racing is both fun and fair. Below is an outline of the ten basic rules which cover most racing situations. For completeness and total accuracy, refer to *Racing Rules of Sailing 2013-2016*, published by US Sailing. See www.ussailing.org/rules for details.

1. **Port tack keep clear** of starboard tack.



2. If boats are on the *same tack, and overlapped, the windward boat must keep clear* of the boat to leeward.
3. If boats are on the *same tack, a boat clear astern must keep clear* of a boat *clear ahead*.
4. **When tacking or jibing, keep clear** of boats on a tack.
5. **Avoid collisions.** If you have the right of way and hit the other boat, causing damage or injury, you both will be penalized.
6. **Don't obstruct.** Don't make it hard for the 'keep clear' boat to do so. (No hunting allowed.)
7. **Sail the course** prescribed. You have to round the marks in the directions specified in the Sailing Instructions and can't touch a mark.
8. **Proper Course** (same tack, within two hull lengths). If the leeward boat came from astern, leeward boat shall not sail above its own proper course during the overlap. (Remember that the windward boat still has to keep clear, even if windward is forced above what it believes is windward's proper course. Leeward still has right of way.)
9. **Give room at marks and obstructions** to yachts overlapped on the inside, except:
 - a. When the overlap did not exist before the lead boat reaches the **three-boatlength zone**.
 - b. When approaching a windward mark on opposite tack.
 - c. At a starting mark surrounded by navigable water. That is, you don't have to let a barge in at the start except to avoid collision (then protest).
10. **Acknowledge your fouls and protest those who don't.**

A free rule book comes with US Sailing membership. See www.ussailing.org.



VALLEJO MARINA

Gateway to the Bay & Delta



JOIN US!

We love making new friends and spoiling them!

- Competitive Rates
- Ample Guest Dock
- Full Service Boat Yard and Chandlery
- 2 Restaurants for Breakfast, Lunch, Cocktails and Dinner
- Covered and Open Berths

2015 VALLEJO RACE May 2 & 3



Race to Vallejo for Dinner!

Photo by Peter Lyons • www.lyonsimaging.com



- One hour from Sacramento
- Only three hours from Reno
- Easy access to San Francisco Bay and the Delta

(707) 648-4370

Fax (707) 648-4660 • Marina@ci.vallejo.ca.us

42 Harbor Way • Vallejo, CA 94590

www.ci.vallejo.ca.us

HELPFUL INFO FOR FILLING OUT AN NCPHRF APPLICATION

Getting a PHRF (Performance Handicap Racing Fleet) rating for your boat is one of the easiest ways to get involved in the myriad forms of Bay Area racing. If you have a well-known sailboat, it's likely the local YRA already has a rating number assigned for your boat type. However, many boats have been modified or may have different sail sizes affecting their speed. For this reason, all boats need their measurements submitted for the YRA to give you a rating. To make it easier, the YRA is providing the instructions that follow to help you fill out the rating form on page 57.

For unmodified class boats, common measurements for items such as I, J, P and E, as well as ballast and displacement, can be found online, in a sales brochure, or even from your sailmaker. However, if you have a modified or non-class boat – or cannot find all the required information for your class boat – the following guidelines can help walk you through the required measurements.

If you do have questions, please call the local YRA office at (415) 771-9500 or email info@yra.org.

SAIL NUMBER

This should be a number that the YRA office has assigned to your boat. Please call the YRA office for more information. Sail Prefix is a country code. This space can be blank or it might say USA or IRL.

CLASS/TYPE

We are looking for the type of boat you have – like a Cal 20 or Islander 36. If your boat is custom-made or one-of-a-kind, please indicate so. If it was designed under some rule, please tell us what rule; e.g., 6-meter, IOR 1/4-ton, etc. In this case, if you have any measurement certificate, no matter how old, please include a copy of it with your application for rating.

ONE DESIGN RATING

Refer to the NCPHRF Rules (www.yra.org) to find out if this applies to you. It is anticipated that other members in your class who know and understand your rules and limitations, as modified by Section V, will monitor the OD ratings.

RIG AND SAIL MEASUREMENTS

What is the source of the information provided? We are looking for where you obtained the information on your certificate. Please indicate by circling which sources apply.

FORETRIANGLE

- I Vertical distance from upper point of 'I' to lower point of 'I'
Upper point of 'I' is the highest of:
 1. Intersection of mast and highest jibstay.
 2. Highest sheave for jib halyard drawn horizontal to mast.Lower point of 'I' is the sheerline abreast the mast (not the cabin top).
The sheerline is the intersection of the deck and the hull.
- J Horizontal distance from mast to where the forward-most jibstay intersects the deck, or jib tack. Note that 'JC' is no longer on this form.

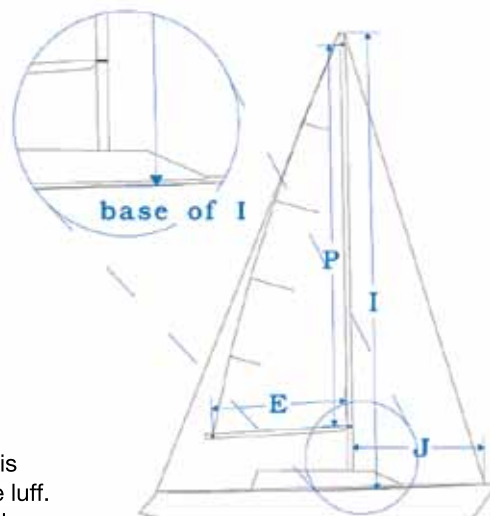

LARGEST HEADSAIL

Largest Headsail percent is $LP/J \times 100$. The LP (Luff Perpendicular) of your jibs is determined by measuring the distance from the clew to the nearest point on the luff. This is done by holding the zero end of a tape measure at the clew (defined as the intersection of the leech and the foot), removing the wrinkles from the area to be measured, and swinging an arc up and down the luff, recording the minimum distance, then dividing by J and multiplying by 100. For example, suppose you measure an LP of 15.5 feet on your biggest headsail, and your J is 10 feet. Your largest headsail is $15.5/10 \times 100 = 155\%$, which happens to be the largest non-penalty headsail allowed under PHRF for a 10-ft J. Your sailmaker is also a source of information on sail dimensions.

ISP ('I' for the spinnaker)

ISP = spinnaker hoist. Measured from the underside of the spinnaker halyard, when drawn horizontally forward from the mast, to the level of the sheerline abreast the mast. The sheerline is the intersection of the deck and the hull.

Note: In most cases, 'I' and 'ISP' are the same. It is common for sport boats, like Melges 24s and most J/Boats with a bow pole, to have an 'ISP'. If your spinnaker halyard exits the mast above the upper point of 'I' as described above, then you need to fill in your 'ISP'.

JSP (for boats with sprits and asymmetric spinnakers only)

JSP = spinnaker 'J' horizontal distance from mast to the forward most attachment point for the spinnaker tack.

If this location is adjustable, as with an adjustable bow pole, then measure with the bow pole fully extended.

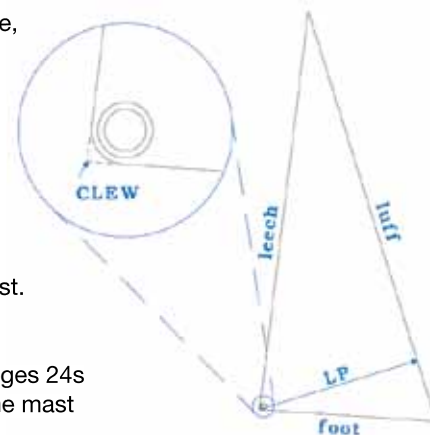

continued on page 50



2015 OYRA Series

April 25th

May 9th

June 6th

June 27th

July 25th

August 22nd/23rd

September 19th

October 3rd

The YRA ocean racing series features races on and around the Gulf of the Farallones. Divisions available for full crewed boats, single and double handed boats and multihulls. Racers can sign up for the series or for individual races.

The Race Sign Up, Notice of Race, and Sailing Instructions for each regatta will be available at www.yra.org.

Daily and Series Championship trophies will be passed out on Nov. 17th, 2015 at the Berkeley Yacht Club.

HELPFUL INFO FOR FILLING OUT AN NCPHRF APPLICATION

TYPE OF RIG

Sloops come in two varieties: 'masthead,' where the forestay goes to the top of the mast; and 'fractional,' where the forestay is anchored to the mast somewhere below the top of the mast. Other types of rigs include ketch, yawl, cutter or catboat.

MAST MATERIAL

What is your mast made of? Common materials are aluminum, wood, carbon, fiberglass, and 'other.'

STANDING RIGGING MATERIAL

What material are your shrouds made of? In part, we are looking for boats that have changed their standing rigging.

MAINSAIL

P = Mainsail Hoist (distance between bands)

E = Mainsail Foot (distance from aft edge of mast to the inner edge of the band on the boom)

HB = Headboard

MGU and MGM

MGU (Main Girth Upper) and MGM (Main Girth Middle) are girths measured on your mainsail. These girths measure the width of mainsails one-quarter and one-half the distance down the leech from the head. Measure your girths by folding the head (front corner of headboard) to the clew, smoothing the leech and marking the fold at the leech (MGM startpoint). Next, fold the head to the mid-leech point and mark this new fold on the leech (MGU starting point). Now lay the sail out flat. Hold the zero end of a tape measure at the MGM starting point on the leech. Swinging an arc up and down the luff, record the minimum distance measured as your MGM. Remove the wrinkles from the area to be measured. Repeat this process for measuring your MGU.



Py and Ey are similar to P and E dimensions for the aft sail on ketches, yawls and schooners.

continued on page 52

UNI-TITANIUM[®]
ULTIMATE PERFORMANCE

buy with confidence
Race With Confidence

UK Northern California
2021 Alaska Packer Pl.
Alameda, CA 94501
Tel: 510-523-3966

UK
SAILMAKERS

The advertisement features a photograph of a blue racing yacht with crew members on deck, sailing on a blue sea. The text is overlaid on the image. The UK SAILMAKERS logo is in the bottom right corner.



2015 Spring/Summer Series

Spring Series

April 18th
May 16th
June 13th

Summer Series

July 11th
August 8th
September 12th

The YRA Spring/Summer features races on San Francisco Bay. The series is open to boats with PHRF or ORR rating certificates, and One-Design fleets. One-Design fleets need a minimum of five boats to race as a class. Most fleets chose to hold two races on each race date.

Racers can sign up for each individual series, or for both. The Race Sign Up, Notice of Race, and Sailing Instructions for each regatta will be available at www.yra.org.

Series Championship trophies will be passed out on Nov. 17th, 2015 at the Berkeley Yacht Club.

HELPFUL INFO FOR FILLING OUT AN NCPHRF APPLICATION

SYMMETRIC SPINNAKER

Symmetric spinnakers have the following characteristics: (a) luffs are of equal length; (b) the sail is symmetric about its vertical centerline.

SL = Spinnaker Luff (Refer to the NCPHRF Rules at www.yra.org for the non-penalty limit.)

SSMW (Symmetric Spinnaker Maximum Width)

SSMW is determined by measuring the width of your sail at various locations equidistant down the luffs from the head. It would be common to find several of these widths to be close to the same maximum value. Write down the largest number you measure.

SSF = Spinnaker Foot Length

SPL = Spinnaker Pole Length

Spinnaker Pole Length is the length of the spinnaker pole when set in position on the mast; measured from the front face of the mast to the extreme outboard end of the pole. Please note the distinction between a whisker pole and a spinnaker pole: A whisker pole may be used to pole out any jib (but may NOT attach to any type of spinnaker), may be of any length, and may be adjustable. Information on your whisker pole is not required by PHRF, and should not be used as an answer for the spinnaker pole length, as it will often draw an unnecessary penalty.

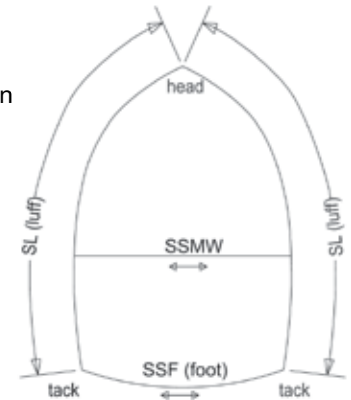

ASYMMETRIC/CRUISING SPINNAKERS

Non-Penalty Area Limits

Cruising/Asymmetric Spinnakers are limited in area not to exceed the area of I and J – or ISP and SPL – based 180% symmetric spinnakers for that boat. To calculate the actual area for the symmetric spinnaker, use the formula for “Area” below, substituting SL (symmetric spinnaker luff) for SLU and SLE.

The formula for determining the actual area of all types of spinnakers is as follows:

$$\text{Area} = (\text{SLU} + \text{SLE}) \times .25 \times \text{ASF} + (\text{ASMG} - .5\text{ASF}) \times (\text{SLU} + \text{SLE}) / 3$$

In the case of Symmetric Spinnakers, replace SLU and SLE with SL, ASMG with SSMW, and ASF with SSF.

SLU = Spinnaker Luff Length

SLE = Spinnaker Leech Length

ASMG = Spinnaker mid-girth measured between the mid-points of the spinnaker luff and spinnaker leech

ASF = Spinnaker foot length

Note on ASMG:

ASMG less than $.75 \times \text{ASF}$ is not allowed.

Sprit Length:

We want to know how far in front of your forestay you can tack your asymmetric or cruising spinnaker. If you have a bow sprit that is adjustable in length, we want the distance from the forestay to the block at the front of the sprit when the sprit is fully extended. If you tack the sail to the stem, but the stem extends in front of the forestay, use the distance from the stem to the forestay. If you tack the sail to the stem and the forestay connects to the deck at the stem, enter zero for sprit length.

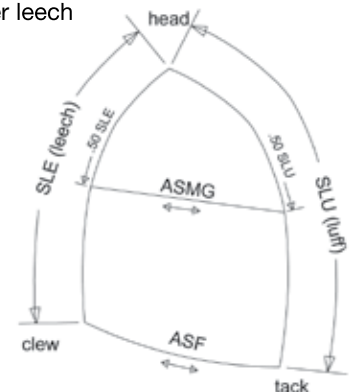

How far aft can you articulate your spinnaker tack?

0 degs (fixed)

___ degrees

We want to know if you plan on setting the tack of your cruising or asymmetric spinnaker on a pole that can be squared aft. Sails set from the bow of the boat, or from a non-rotating pole (bow sprit), are of the zero degree category. If the tack of the sail is set on a pole that can be rotated while sailing, we want to know the maximum angle of rotation, measured at the mast between the centerline of the yacht and the pole.

Please fill out the following two fields in the “Foretriangle” box:

ISP = Spinnaker hoist, measured from the underside of the spinnaker halyard, when drawn horizontally forward from mast, to the level of the sheerline abreast the mast.

continued on page 54



2015 WBYRA Series

April 19th

May 2nd

May 16th

August 1st

August 15th

September 26th

The YRA WBYRA series features races for classic wooden boats. Divisions available for Bear, Bird, IOD, Knarr, and Folkboat fleets.

The Race Sign Up, Notice of Race, and Sailing Instructions for each regatta will be available at www.yra.org.

Series Championship trophies will be passed out on Nov. 17th, 2015 at the Berkeley Yacht Club.

HELPFUL INFO FOR FILLING OUT AN NCPHRF APPLICATION

JSP = Farthest distance from front of mast to asymmetric spinnaker tack location. Note that this can be much greater than J on sprit boats.

Setting and Sheeting Limits: For Asymmetric spinnakers:

TACK: Sail may be tacked to the deck or to a pole. PHRF Application must state if the pole can be articulated to move the tack off hull centerline and how many degrees it can move. JSP must be recorded if greater than J.

HEAD: Halyard location may be at any height on the mast. If the dimension ISP is greater than I, then ISP must be recorded on the application.

CLEW: Sail may be sheeted consistent with the RRS. Racing Rules of Sailing can be found on the US Sailing website at: www.ussailing.org/rules.

The performance of Cruising/Asymmetric Spinnakers is not yet completely defined. Boats with excessive JSPs or ISPs and boats with the ability to move the tack of the sail off centerline may incur some rating adjustment. The PHRF Committee will be studying the performance of these various arrangements, and, if considered necessary by this committee, this rule and/or its limits may change.

HULL MEASUREMENTS

Drawings and photos are not required for well-documented production boats. However, if the boat is relatively rare, or not common in the Bay Area, drawings and/or photos are a must. We cannot rate an unknown boat using only the information on the application form. Measurements below are for the boats in 'measured trim,' not 'sailing trim,' using IMS wording. Your boat is equipped as it would be for racing, but without crew, sea bags, or consumable supplies, and with all tanks empty.

HULL

LENGTH OVERALL

How long is your boat? If it has a bowsprit, please give the length of the hull and the bowsprit separately.

WATERLINE LENGTH

How long is the part of the boat in the water? Ignore the rudder.

MAXIMUM BEAM

What is the width of your hull at its widest point?

MAXIMUM DRAFT

What is the depth of the lowest point of the keel or board below the waterline? If the boat has a lifting board or keel of any type, draft is measured with this device fully lowered. Give the change in draft with the board raised separately.

DISPLACEMENT

TOTAL

This is the weight of your boat ready to race as described above.

BALLAST

We are looking for the weight of your keel. PHRF requires minimum ballast of 400 pounds. If your boat has 'internal ballast', it should be included. Internal ballast is typically in the form of lead ingots bolted to the hull, and is NOT in the form of usable equipment or supplies. If your boat has been measured under some rating rule, and you have subsequently removed the internal ballast, this change must be reported in writing to the PHRF Committee.

BALLAST MATERIAL

Typical answers here are lead or iron, and sometimes water.

TRAPEZE/HIKING STRAP

These are allowed in One-Design Classes where the class rules clearly state that the hiking aids are allowed. They may not be used unless your PHRF application so indicates.

continued on page 56



2015 Weekend Regattas

Great Vallejo Race
May 2nd & 3rd

2nd Half Opener
August 1st & 2nd

Westpoint Regatta
July 18th

Season Closer
September 26th & 27th

The YRA Weekend Regattas are some of the longest running regattas on San Francisco Bay. Sail one or all of the races. Divisions available for PHRF boats, ORR boats, Sportboats, One Design Fleets, and Multi-hulls. Short-handed and non-spinnaker fleet options may also be available.

Saturday races feature a distance race with great after race activities. Sunday races are generally shorter.

The Race Sign Up, Notice of Race, and Sailing Instructions for each regatta will be available at www.yra.org.

HELPFUL INFO FOR FILLING OUT AN NCPHRF APPLICATION

MOVABLE BALLAST

Does your boat have ballast that can be moved while sailing? The possibilities include:

- (a) Water ballast which can be moved from side to side – or discharged for runs and restored for beating.
- (b) Keels which can be inclined or canted.
- (c) And others.

Movable ballast presents several difficulties. The biggest is in US Sailing/Racing Rules of Sailing (2013-2016) Rule #51 (Moving Ballast), which states quite clearly that movable ballast is not legal when racing under the US Sailing rules. There are a (very) few races where the race instructions alter the RRS, and specifically allow movable ballast, which is why this is on the PHRF form at all. If you use movable ballast, it is your responsibility to be sure that it is legal in the races in which you are sailing. *Just because it is on your PHRF Certificate does not mean you can race with a movable ballast.*

KEEL TYPE

FIXED

If your keel cannot be moved while you are sailing, then we consider it fixed.

MOVABLE

If your keel can be moved while you are sailing, then we consider it movable, and we need to know about it. This includes keels that move up and down, pivot around a pin (swing keel), or cant from side to side.

KEEL/CENTERBOARD

This is really a sub-class of movable keels, where the boat has a conventional keel, but also has a foil that can extend down below the bottom of the keel.

ENGINE

Do you have an inboard, outboard, or no engine at all?

PROPELLER

We need to know the number of blades on the propeller, and whether they are fixed blades or folding/feathering. If the engine is an outboard, we assume the propeller is not in the water while you are racing, so in the case of outboards, we do not consider what type of propeller you have.

MODIFICATIONS

UNMODIFIED CLASS BOAT

Check this box if your boat is a serially produced yacht that has not been altered.

MODIFIED CLASS BOAT

Check this box if your boat was originally a production yacht, but has undergone changes since its original manufacture. Examples include: a new keel, change in ballast, new rudder, new mast made of different material than the original, different number of spreaders on the mast, change in hull shape, etc. Include anything that would make you *unwelcome* racing against your unmodified sisterships.

NON-CLASS CUSTOM BOAT

Check this box if your boat is essentially a one-of-a-kind custom boat. If your boat is of this type, please refer to the NCPHRF Rules at www.yra.org for information we will need to handicap your boat.

DESCRIBE MODIFICATIONS

Please explain modifications, movable ballast, hiking aids here. Please feel free to write on the back of the form if you need more space.

RATING FEES

New Certificates: YRA Members, \$50; Non-Members, \$75

Renewals: YRA Members, \$35; Non-Members, \$65

Out of Area Certificates (boats hailing from outside of US Sailing Area G): \$75

NORTHERN CALIFORNIA PHRF RATING APPLICATION 2015

1070 Marina Village Pkwy, Ste 202-G, Alameda, CA 94501

Phone: (415) 771-9500 E-mail: PHRF@yra.org Fax: 415-276-2378

THIS FORM IS FOR BOATS NOT PREVIOUSLY RATED OR BOATS WHICH DID NOT HAVE A 2014 CERTIFICATE.

The NCPHRF Committee has no responsibility for the seaworthiness or safety of yachts rated, but cites US SAILING Fundamental Rule 4, "It shall be the sole responsibility of each yacht to decide whether or not to start or to continue to race."

Name: _____	Boat Name: _____	Sail Number: _____
Street: _____	Boat Model: _____	
City, State, Zip: _____	Manufacturer: _____	Yr Built: _____
Evening Phone: _____	Daytime Phone: _____	Designer: _____
Yr. Designed: _____		
Email Address: _____	US Sailing #: _____	YRA Member #: _____
Yacht Club Affiliation: _____	Marina: _____	Berth/Slip #: _____

Please refer to the NCPHRF Rules and Guidelines for assistance in successfully completing this application

Do you want an ODR (One Design Rating)? What is the source of the information provided? Circle all that apply.
 YES NO N/A Measurement Certificate Sales Brochure Class Rules Sailmaker Designer Own Measurement

Please provide accurate drawings or pictures showing side and end views of your boat from deck to bottom of keel and attach to this application. Where possible, give measurements in feet and decimals.

<p style="text-align: center;">Foretriangle</p> <p>I: <input type="text"/> J: <input type="text"/></p> <p>Largest Headsail: <input type="text"/> % J</p> <p>ISP: <input type="text"/> JSP: <input type="text"/></p> <p>Type of Rig: <input type="text"/></p> <p>Mast Material: <input type="text"/></p> <p>Standing Rigging Material: <input type="text"/></p>	<p style="text-align: center;">Main</p> <p>P: <input type="text"/></p> <p>E: <input type="text"/></p> <p>HB: <input type="text"/></p> <p>MGU: <input type="text"/></p> <p>MGM: <input type="text"/></p> <p style="text-align: center;">Mizzen</p> <p>PY: <input type="text"/></p> <p>EY: <input type="text"/></p>	<p style="text-align: center;">Symmetric Spinnaker</p> <p>Yes/No <input type="checkbox"/></p> <p><i>If yes, complete the following:</i></p> <p>SL: <input type="text"/></p> <p>SSMG: <input type="text"/></p> <p>SSF: <input type="text"/></p> <p>SPL: <input type="text"/></p>	<p style="text-align: center;">Asymmetric/Cruising Spinnaker</p> <p>Yes/No <input type="checkbox"/></p> <p><i>If yes, complete the following:</i></p> <p>SLU: <input type="text"/></p> <p>SLE: <input type="text"/></p> <p>ASMG: <input type="text"/></p> <p>ASF: <input type="text"/></p> <p style="text-align: right;">Sprit Length: <input type="text"/></p> <p><small>How far aft can you articulate your spinnaker tack?</small></p> <p><input type="checkbox"/> Fixed @ 0 deg or: <input type="text"/> Degrees</p>
---	---	--	--

<p style="text-align: center;">Hull</p> <p>Length Overall: <input type="text"/></p> <p>Waterline length: <input type="text"/></p> <p>Maximum Beam: <input type="text"/></p> <p>Maximum Draft: <input type="text"/></p>	<p style="text-align: center;">Displacement</p> <p>Total: <input type="text"/> lbs</p> <p>Ballast: <input type="text"/> lbs</p> <p>Ballast Material: <input type="text"/></p> <p># of Trapezes/Hiking Straps: <input type="text"/></p> <p>Is any of your ballast moveable? <input type="checkbox"/></p>	<p style="text-align: center;">Keel</p> <p>Fixed, Moveable or Keel/Centerboard?</p> <p><input type="text"/></p>	<p style="text-align: center;">Engine</p> <p>Inboard, Outboard or None?</p> <p><input type="text"/></p>	<p style="text-align: center;">Propeller</p> <p># of Blades (2 or 3)?</p> <p><input type="text"/></p> <p>Fixed, Folding or Feathering?</p> <p><input type="text"/></p>
---	--	--	--	---

This is a: Unmodified Class Boat Modified Class Boat: Non Class (Custom) Boat see Rules and Guidelines Part 1, II, E

Modifications Describe modifications/Comments/Moveable Ballast/Trapeze or Hiking Straps below:

The NCPHRF rating certificate is a contract between you, the NCPHRF Committee, and your competitors. You and your competitors expect this form to be accurate and that the reported characteristics will be maintained while racing. Failure to advise the NCPHRF Committee in writing of ANY modification to your boat which will alter its sailing performance may be grounds for protest and disqualification of the yacht. Your rating is valid through December 31 of the year issued. I certify that the above information is accurate and correct, that I have read the NORTHERN CALIFORNIA PHRF RULES AND GUIDELINES, and concur with, and agree to sail by those terms and conditions.

Signature of owner _____ **Date:** _____

Rating Fees: \$50 for YRA members (\$100 including YRA membership), \$75 for non-YRA members and for out-of-area (outside USS AREA G) boats. Make check payable to YRA. To pay by MasterCard or VISA please provide card information below, including billing street address and zip code.

Card Number: _____ Exp Date: _____ CVV # _____ Name on Card: _____
 Card Holder's Signature: _____ Billing Address: _____

Office use only

PHRF Rating: _____ C.C. Check # _____ Amount PD _____ Date Rec'd in office _____



PINEAPPLE SAILS
 Phone (510) 522-2200
 Fax (510) 522-7700
 www.pineapplesails.com
 2526 Blanding Ave., Alameda, CA 94501

Stocking Dealers For

MUSTO

Foul Weather Gear



dubarry
of Ireland

Sailing Footwear

spinlock

PFDs and Tethers



When only the best will do

FLAGS

A		J		S			
B		K		T			
C		L		U			
D		M		V			
E		N		W			
F		O		X			
G		P		Y		'Y' FLAG: Life Jackets must be worn.	
H		Q		Z			
I		R		0			
1		2		3			
4		5		6			
7		8		9			

★ For Bay Area Weather Call (831) 656-1725 ★

JANUARY 2015

● indicates full moon.

→ indicates 2-day races. **YRA events indicated in bold type.**

S	M	T	W	Th	F	S
4	5	6	7	8	9	10
11	12	13	14	15	16	17
18	19	20	21	22	23	24
25	26	27	28	29	30	31

WEEKDAY & SPECIAL EVENTS	SATURDAY	SUNDAY
<p>January 1:</p> <ul style="list-style-type: none"> Welcome to 2015 Brrrr Rabbit, CPYC – SB <p>January 18-23:</p> <ul style="list-style-type: none"> Quantum Key West Race Week, Premiere Racing – Key West, FL <p>January 19:</p> <ul style="list-style-type: none"> Martin Luther King Jr. Day <p>January 22-25:</p> <ul style="list-style-type: none"> Progressive Insurance San Francisco Boat Show, NMMA – McCovey Cove/Pier 48 <p><i>Note: For more events, please see our Lake Circuit column on pages 72-78.</i></p>	<p>Midwinter #3, GGYC – City Winter #3, SeqYC – SB Tiny Robbins Midwinter #3, VYC – NB Perry Cup/Midwinters, MPYC</p> <p style="text-align: right;">3</p>	<p>Sunday Brunch #1, OYC – Estuary Chowder #12, BYC – OC Midwinter #3, SYC – Knox Small Boat Midwinters #2, RYC – SH Midwinters #2, RYC – SH</p> <p style="text-align: right;">4</p>
	<p>Midwinters #5, BYC – OC Redwood Cup #3, SeqYC – SB Midwinter Madness #3, BVBC – SB/SF Jack Frost #2, EYC – YRA 10 Frostbite Series #3, BenYC – Carquinez Midwinters #1, TYC – NB Little Daddy, RYC – SH Winter One Design, RegattaPRO – OC Santana 22 Team Racing, SCYC</p> <p style="text-align: right;">10</p>	<p>Midwinter #3, IYC – Estuary Midwinters #6, BYC – OC Winter Beercan #1, CPYC – SB Whales Chase, BBYC</p> <p style="text-align: right;">11</p>
	<p>Midwinters #1, CYC – Knox → Island Fever #3, SBYC – SB/SF Midwinters #3, SCYC</p> <p style="text-align: right;">17</p>	<p>Midwinters #2, CYC – Knox Sunday Brunch #2, OYC – Estuary Chowder #13, BYC – OC</p> <p style="text-align: right;">18</p>
		<p>Chowder #14, BYC – OC Winter Beercan #2, CPYC – SB</p> <p style="text-align: right;">25</p>
	<p>Three Bridge Fiasco, SSS – CB Opti Midwinters #2, RYC – SH</p> <p style="text-align: right;">31</p>	



PINEAPPLE SAILS

(510) 522-2200

www.pineapplesails.com

2526 Blanding Avenue
Alameda, CA
94501

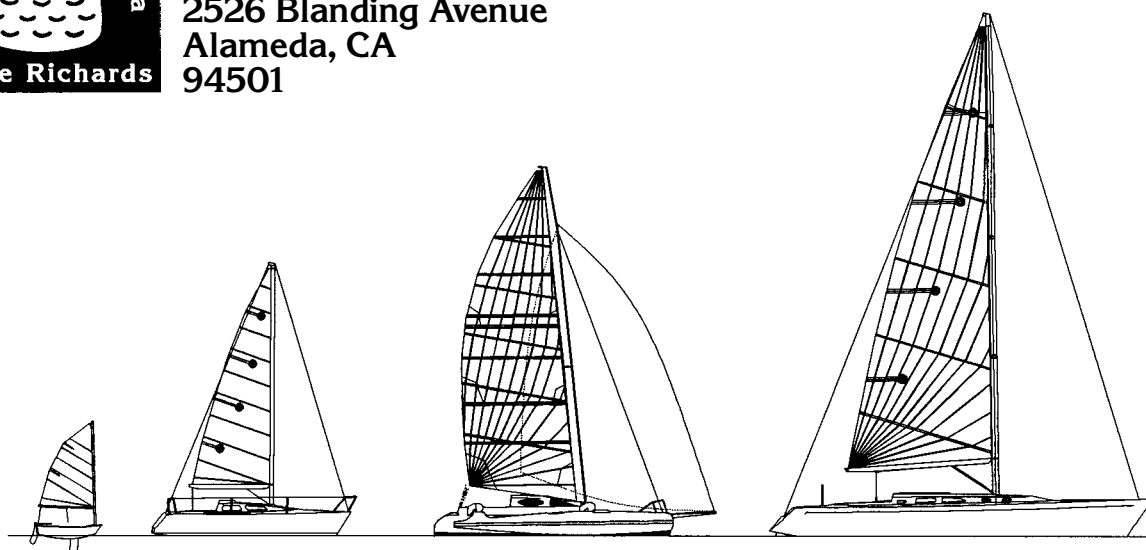

SAILS - in just your size and in the fastest of shapes!

SANTA CRUZ...THE FUN WAY 2015



Get out of the Bay for Labor Day!

Sail San Francisco to Santa Cruz – Friday, September 4

Racing Division

The 70-mile sprint is a great summer end showdown for all Type A's!

Cruising Division

The 70-mile rally with comfortable engine allowance is the laid back way for all Type B's!
Stay and cruise Monterey Bay

Racers and cruisers mix it up Saturday and Sunday with Santa Cruz Yacht Club hosting Saturday awards ceremony and party

Registration Includes: Regatta
All-night Friday chowder service
Two nights rafted-up party with your friends

For race information visit: www.scyc.org/windjammer

MIDWINTER & FRIDAY NIGHT SERIES

★ ALL BOATS WELCOME ★

Midwinters: Jan. 17-18 & Feb. 21-22
3rd Annual Rob Moore
Memorial Regatta: Feb. 21

Friday Nights: April 17-Aug. 28

Post-Race Festivities – Bands, BBQ & Fantastic Speakers

Our **64th**
Annual
Midwinters!



Corinthian Yacht Club

OF SAN FRANCISCO

43 MAIN, TIBURON, CA 94920 • (415) 435-4771

Visit our website: www.cyc.org

YOUTH SAILING

Looking for a new way to entertain your kids this year? Look no further than the Bay Area's dozens of junior sailing programs. Many offer scholarships, and, with rare exception, you don't need to have your own boat. Unless noted below, club membership is not necessary. High School sailing for students in grades 9-12 takes place around Northern California in the Pacific Coast Interscholastic Sailing Association. If your high school doesn't have a team – or enough students to field a team – don't fret. Most programs allow students from several schools to form a single team.

ALAMEDA COMMUNITY SAILING CENTER

(510) 629-9282 messages, www.sailalameda.org

Summer Camp, ages 7-18

When: June and July. Skill Levels: Beginner, Intermediate, Advanced

Sessions: 2 weeks, M-F, 9 am-4 pm (Extended Care 8:30 am-5 pm)

Session 1: June 15-26; Session 2: June 29-July 10; Session 3: July 13-24;

Session 4: July 27-August 7; Session 5: August 10-21. Boats: JY Trainers, FJs

BENICIA YC

Derith Lutz, (707) 746-0739, youthsailing@beniciayachtclub.com,
www.beniciayachtclub.com

Half Day Camp, elementary school age up to age 12 with no sailing experience.

When: One-week session in June TBA.

Boats: DeWitt Dinghies and Optimists (provided). Cost: \$275

Summer Session I, ages 10-18 or young sailors with experience.

When: One-week camp, July/August TBA.

Boats: DeWitt Dinghies and Optimists (provided). Cost: \$375

Summer Session II, more experienced sailors.

When: July/August TBA.

Boats: DeWitt Dinghies, Optimists, C15, CFJ (provided). Cost: \$375

YC member discounts, sibling and multiple camp discounts, and scholarships available on all programs.

High School Program

When: Once a month. Boats: DeWitt Dinghies, Optimists, C15, CFJ (provided).

Cost: Sponsored by BenYC for Benicia High School students.

Open Sailing

For pre-qualified individuals with certification.

BLUE WATER FOUNDATION (San Francisco)

(415) 392-2018; www.bluewaterfoundation.org

Thursday Sails: Afternoon sail programs with SF Unified School District and SF Police Department.

Tuesday Sailing Club: Two groups with 8 students each, sails almost every week for the school year.

Gleaming Ocean Program: Four-month intensive sailing and teamwork course teaching cruising skills to selected high school students on a 43-ft Hans Christian cutter. Emphasis on building teamwork and self-confidence; mentor system is utilized.

Oceans Gate Program: Working with Alameda County Probation Department; convicted youth are given the opportunity to make their way back to society; offering both daysails and a multi-month intensive sail training program that will "graduate" successful students by ocean sailing.

CALL OF THE SEA (Sausalito)

(800) 401-7835 or (415) 331-3214, www.callofthesea.org

Bay Explorations: 3-hour daysails with 'sailor for a day' or 'oceanographer for a day'. On all voyages, students will set sail and participate in three rotating learning stations.

Voyage Seaward Overnight Programs: 3 or 5-day overnight program; youth

continued on page 62

FEBRUARY 2015

● indicates full moon.

→ indicates 2-day races. **YRA events indicated in bold type.**

S	M	T	W	Th	F	S
1	2	3	4	5	6	7
8	9	10	11	12	13	14
15	16	17	18	19	20	21
22	23	24	25	26	27	28

WEEKDAY & SPECIAL EVENTS

- February 14:** • Valentine's Day: Take your sweetheart for a sail.
- February 16:** • President's Day: Take your president for a sail!
- February 21-22** • Advanced Race Management Seminar, StFYC
- Feb. 28-Mar. 1:** • Team Race 101, StFYC – City



SATURDAY

- Midwinter #4, GGYC – City
- Midwinter #4, SeqYC – SB
- Double Up and Back, CPYC – SB
- Midwinters #2, TYC – NB
- Tiny Robbins Midwinters #4, VYC – NB
- Perry Cup/Midwinters, MPYC
- Midwinters #3, RYC – SH **7**
- BAYS Winter Optis, EYC – Estuary →
- Midwinters #7, BYC – OC
- Midwinter Madness #4, BVBC – SB/SF
- Frostbite Series #4 Sweetheart Race, BenYC – Carquinez
- Santana 22 Team Racing, SCYC
- Winter One Design, RegattaPRO – OC **14**
- BAYS HS Regatta, EYC – Estuary →
- Midwinters #3/Rob Moore Memorial Regatta, CYC – Knox →
- Redwood Cup #4, SeqYC – SB
- Island Fever #4, SBYC – SB/SF
- Jack Frost #3, EYC – YRA 10
- Midwinters #4, SCYC
- Londerville Cup, HMBYC – HMB **21**
- Single/Doublehanded #1, SeqYC – SB
- Frostbite Series #1, ElkYC – Moss Lndg **28**

SUNDAY

- Sunday Brunch #3, OYC – Estuary
- Chowder #15, BYC – OC
- Midwinter #4, SYC – Knox
- Small Boat Midwinters #3, RYC – SH **1**
- Midwinter #4, IYC – Estuary
- Chowder #16, BYC – OC
- Winter Beercan #3, CPYC – SB
- BAYS Winter Optis, EYC – Estuary
- Sunday Brunch #4, OYC – Estuary
- Midwinters #8, BYC – OC
- Whales Chase, BBYC **15**
- BAYS HS Regatta, EYC – Estuary
- Midwinters #4, CYC – Knox
- Sadie Hawkins, IYC – Estuary
- Chowder #17, BYC – OC
- Winter Beercan #4, CPYC – SB **22**

LARRY BASKIN



Take Your Program to the Next Level with Quantum® Sails

- Winning sails
- Regatta planning and support
- Tuning and boat handling information
- Coaching on strategy, tactics, teamwork
- Clinics and practice races
- Sail care services



QUANTUM SAIL DESIGN GROUP
WWW.QUANTUMSAILS.COM



Quantum Pacific • 1230 Brickyard Cove • Pt Richmond, CA 94801 • 510-234-4334 • sanfrancisco@quantumsails.com

Photography: simonson/h2shots.com



BAMA

Bay Area Multihull Association

36TH Annual

Double Handed Farallones Race



March 28

JAN ROLETTO

Bay Area Multihull Association

- Competitive Racing
- BAMA Cup Series
- Web Based Crew List
- Monthly Cruise-outs
- Multihull Seminars
- Social Activities

DHF2015@sfbama.org
Info@sfbama.org
650-394-6343

www.sfbama.org

2015 Wheeler Regatta

April 11 & 12



Saturday: Buoy racing for monohulls and multihulls
Deep water courses

Sunday: Pursuit Race

Berkeley Yacht Club

Details at:

www.Berkeleyyc.org

Contact: Bobbi Tosse

Bobbi@jfcbat.com • (925) 939-9885

YOUTH SAILING

continued from page 60

CALL OF THE SEA (cont'd)

experience nature and build self-confidence through the challenge of sailing a traditional tall ship. Call of the Sea has several collaborative partners that send underserved students on Voyage Seaward.

COYOTE POINT YC (San Mateo)

Gwen Daly, (650) 678-1342, www.cpyc.com

Youth Sailing Summer Camp, ages 8-12

When: One-week sessions, August, M-F 9 am-4 pm.

Boats: 9 Optimists, 2 Lasers.

Cost: \$375/week. 10% discount for second child.

ENCINAL YC (Alameda)

Hannah Tuson-Turner, (510) 769-0221, juniors@encinal.org, www.encinal.org

Summer Learn to Sail Program, ages 6-18, all levels

When: 3-week sessions starting June 15, Monday-Thursday AM or PM.

Boats: Optimists, FJs, J/24s (provided).

Junior Race Team, ages 9-18 by application only

When: Spring/Summer/Fall.

Boats: Optimists, Lasers, 420s (provided).

High School Program, grades 8-12

When: Weekends and after school September-April. Boats: FJs (provided).

Scholarships available through the Encinal Sailing Foundation.

GOLDEN GATE YC (San Francisco)

Christine Ghiati, (415) 812-2113; Dave Santori, (510) 693-9104; www.ggyc.org

High School Sailing, grades 8-12 with or without experience

When: Tuesdays and Thursdays, 4-6:30 pm, during the school year.

Interscholastic regattas available to students who attend practice regularly and go to the same school (skipper + crew = a team).

Boats: FJs, 420s (provided).

Cost: \$100 per session (fall, winter or spring); \$300 for the whole school year.

Annual league fee for teams: \$120 + regatta expenses.

Scholarships available through the GGYC Youth Sailing Foundation.

INVERNESS YC

Maggie Harmon, (510) 339-3239, maggieafh@gmail.com,

www.invernessyachtclub.org

Summer Program, ages 10-18 (10 by June 1), able to pass swim test; PFD, wetsuit, and helmet required (bring your own).

When: Session I, Monday, June 22-Friday, July 10 (no program July 4);

Session II, Tuesday, July 13-Friday, July 31; 9:30 am-4 pm.

Boats: Optimists, Lasers, O'pen Bics, FJs (provided).

Cost: \$900. Need-based financial aid available.

MONTEREY PENINSULA YC

(831) 372-9686, www.mpyc.org

Summer Sailing Camp, ages 8-16

When: One-week sessions starting in early June through early August, except the week of July 4, 9 am-4 pm.

High School Sailing Program

When: August-May.

NEHEMIAH (Richmond)

Rod & Joni Phillips (510) 234-5054, www.sailingacross.com

Crosscurrent Voyages use experiential education, adventure and managed risk-taking for growth and development. Primary goal is assisting youth and youth at risk to develop a strong sense of character and community, while installing self-esteem in a hands-on situation.

OAKLAND PARKS & REC DEPT.

Sarah Herbelin, (510) 238-2196, sherbelin@oaklandnet.com

www.sailoakland.com

Sailing into Science, fifth graders (teachers may sign up their classes)

Where: Lake Merritt Boating Center. When: School year.

Boats: Pedalboats, dragonboats, kayaks, canoes, whaleboats (provided).

Cost: \$300 per class per day (up to 32 students).

After-School Learn-to-Sail Program, ages 10-17

Where: Lake Merritt Boating Center

continued on page 64

MARCH 2015

→ indicates 2-day races.
YRA events indicated in bold type.

● indicates full moon.

S	M	T	W	Th	F	S
1	2	3	4	5	6	7
8	9	10	11	12	13	14
15	16	17	18	19	20	21
22	23	24	25	26	27	28
29	30	31				

WEEKDAY & SPECIAL EVENTS

- Feb. 28-Mar. 1:** • Team Race 101, StFYC – City
- March 7-8 or 14-15:** • ISAF Survival at Sea Courses, SFYC
- March 11:** • **Latitude 38 Spring Crew List Party at GGYC. Check Latitude 38 for more information or see www.latitude38.com.**
- March 17:** • *St. Patrick's Day: Take an Irish friend sailing!*
- March 20:** • *Vernal Equinox*

SATURDAY

SUNDAY

Spring Dinghy, StFYC – City →
Big Daddy, RYC – OC →
Mercury Series #1, EYC – Estuary
Midwinter #5, GGYC – City
Redwood Cup #4, SeqYC – SB
John Pitcher Memorial, CPYC – SB
Midwinters #3, TYC – NB
Tiny Robbins Midwinters #5, VYC – NB
Long Distance #1, SSC – Stockton

Spring Keel/One Design, StFYC – City →
Rites of Spring, OYC – CB/OC
Rosenblum Regatta, SFYC – Knox
Winter #5/St. Patrick's Day, SeqYC – SB
Midwinter Madness #5, BVBC – SB/SF
Jack Frost #4, EYC – YRA 10
Frostbite Series #5, BenYC – Carquinez
Santana 22 Team Racing, SCYC
Frostbite Series #2, ElkYC – Moss Landing

California Dreamin', StFYC – City →
NorCal HS Champs, SFYC – Richardson or Knox →
Small Boat Races #1, EYC – Estuary
Jaws Pursuit Race, SYC – Knox/SH
Island Fever #5, SBYC – SB/SF
Midwinters #5, SCYC

San Francisco Cup, SFYC – City →
Spring Shorteez, CPYC – SB
Doublehanded Farallones, BAMA – Ocean
Horsfall-Vincent Regatta, CYC – Knox
Corinthian Race, SSS – CB/City/SH
Frostbite Series #3, ElkYC – Moss Landing

Sunday Brunch #5, OYC – Estuary
Midwinter Champions, BYC – OC
Chowder #18, BYC – OC
Midwinter #5, SYC – Knox
Small Boat Midwinters #4, RYC – SH

Spring Dinghy, StFYC – City
Big Daddy, RYC – OC
Midwinter #5, IYC – Estuary
Chowder #19, BYC – OC
Winter Beercan #5, CPYC – SB

DAYLIGHT SAVING TIME BEGINS!

Spring Keel/One Design, StFYC – City
Chowder #20, BYC – OC
Spring Series #1, SSC – Stockton
Warmup Race, PresYC – West CB

California Dreamin', StFYC – City
NorCal HS Champs, SFYC – Richardson or Knox
Chowder #21, BYC – OC
Winter Beercan #6, CPYC – SB

San Francisco Cup, SFYC – City
Chowder Series #22, BYC – OC
Spring Series #2, SSC – Stockton
Champion of Champions Regatta, SCYC

Visit our convenient full-service shop in Alameda



HANSEN RACE RIGGING SERVICES:

Design installation and fine tuning of all race-winning spars, hardware and cordage.

- Masts
- Booms
- Poles
- Deck hardware
- Running rigging
- Installation
- Fabrication
- Custom carbon fiber
- Standing rigging
- Lifelines
- Sheets/halyards
- Ergonomic design
- Weight reduction
- Custom hardware
- Rig pull/restep

HANSEN RIGGING

2307 Blanding Ave., Alameda

(510) 521-7027

hansenrig@sbcglobal.net



www.hansenrigging.com

nke

MARINE ELECTRONICS

MULTIGRAPHIC

One display
for full control

User-friendly graphical color
multifunction display
and sunlight
readable



Control your autopilot, configure
your system, display AIS targets
and choose the data you need
(from 1 to 6 readout per page)
throughout 10 different
user pages.



High Definition
Extra large 5.7"
Viewing angle greater
than 160°
Low power consumption

IMOCA
SUPPORTERS

Classe
FRANCO-BENETEAU

nke-marine-electronics.com

Euro Marine Trading, Inc., 62 Halsey St., Unit M, Newport RI 02840
T (401) 849-0060 - F (401) 849-3230
www.euromarinetrading.com - info@euromarinetrading.com

YOUTH SAILING

continued from page 62

OAKLAND PARKS & REC DEPT. (cont'd)

When: Weekday afternoons during the school year.

Boats: Optis (provided). Cost: \$165/10 weeks.

Basic & Intermediate Summer Programs, ages 10-17

Where: Lake Merritt Boating Center.

When: One-week sessions, June-August.

Boats: Optis, Sunfish, Catalina 14.2, Hobie Wave (provided).

Cost: \$165/Oakland residents; \$198/non-residents.

Advanced Summer Program, ages 11-17

Where: Jack London Aquatic Center (Oakland Estuary).

When: One-week sessions, June-August.

Boats: Hobie 16s, Bytes (provided). Cost: \$195 and up.

Youth Sailing Team, grades 8-12 from any school

Where: Jack London Aquatic Center (Oakland Estuary).

When: Practices and regattas on weekends spring and summer.

Boats: Laser 4.7s or club FJs (provided). Cost: \$395-\$450/season.

Scholarships available for Oakland residents.

PEGASUS PROJECT (Berkeley)

(510) 621-8130, www.pegasusvoyages.org/project.html

Mission is to enable youth to become productive members of a sustainable society through positive outdoor environmental education and by reinforcing life skills. Objective: Lifeskills Sails aboard *Pegasus* for youth including youth at risk; to provide youth participants (and adult crew) with a basic environmental understanding and appreciation of the SF Bay; to provide a multi-year track for underprivileged youth that will enable them to experience their backyard Bay through on-the-water activities.

RICHMOND YC

(510) 237-2821, www.richmondyc.org

Parent or child must be RYC member (jr. membership: \$50/year).

Summer Day Camp, youth and juniors; 8-18

When: June-August

29ers, 420s, FJ, Lasers, El Toros, Optimists.

Dan Brandt, youthsailing@richmondyc.org

Registration at: www.richmondyc.org. Starts March 1.

Sail Camp (sleep away), ages 8-14

One week El Toro clinic. Novice through advanced. Optis are accepted at novice/beginner level only. Bring your own tent. Bring your own boat. (Limited number of club boats available.)

Tim Stapleton, tim@innovativeprintsolutions.com

Registration at: www.sailcamp.org. Starts April 1.

Check website for restrictions and class schedule.

(Priority registration offered to RYC, SSC and SCYC junior and family members.)

Winter Sailing, youth and juniors; 8-18

High School: October-May. Club boats available.

29ers: October-May. Club boats available.

Dan Brandt, youthsailing@richmondyc.org

Lasers: October-March. Some club boats available.

Optimists: October-March. Some club boats available.

El Toros: October-March.

Ornaith Keane, registrar@rycwintersail.com; Kurt Lahr, kurt.lahr@gmail.com

Registration at: www.richmondyc.org. Starts August 1.

SAILING EDUCATION ADVENTURES (San Rafael)

(415) 775-8779 ext. 3, youth@sfsailing.org, www.sfsailing.org/camps

Mini Camp, ages 8-10

Where: Loch Lomond Marina

When: One-week sessions, June-August, M-F, 9 am-1 pm.

Boats: Keel Catalina 16.5s, Capri 14.2s. Cost: \$295. Scholarships available.

Summer Camp Basic/Intermediate, ages 11-16

Where: Marin YC

When: Two-week sessions, June-August, M-F, 9 am-4 pm.

Boats: Laser Picos, Lasers. Cost: \$695. Scholarships available.

Race Camp, ages 11-18

Where: Loch Lomond Marina

continued on page 66

APRIL 2015

→ indicates 2-day races.
YRA events indicated in bold type.

● indicates full moon.

S	M	T	W	Th	F	S
			1	2	3	4
5	6	7	8	9	10	11
12	13	14	15	16	17	18
19	20	21	22	23	24	25
26	27	28	29	30		

WEEKDAY & SPECIAL EVENTS

- April 1:** • Take a fool sailing!
- April 9-12:** • Strictly Sail Pacific, Sail America – Jack London Square, Oakland
- April 22:** • Celebrate Earth Day on the liquid part.
- April 24-26:** • 68th Annual Newport to Ensenada Race, NOSA

SATURDAY

Interconference Collegiate, StFYC – City →
 Trans-Folsom Challenge, FLYC – Folsom Lake
 Andy Byrd Memorial, CPYC – SB
 North Bay Series #1 VYC – NB

4

Wheeler Regatta, BYC – OC →
 Baldwin, StFYC – City →
 Harken Opti Challenge #1, SFYC – NC →
 Big Dinghy, RYC – SH →
 One Design Championship, CYC – Racoon →
 Mercury Series #2, EYC – Estuary
 Small Keelboat #1, SFYC – NC
 Doublehanded Lightship, IYC – Ocean
 Commodore's Cup, BVBC – SB/SF
 Don Wan Regatta, TYC – NB
 Bullship, El Toros – Sausalito to SF
 DH Long Distance, SSC – Stockton
 Frostbite Series #4, ElkYC – Moss Landing
 Commodore's Regatta, SCYC
 South Bay Interclub #1, CPYC – SB

11

YRA Spring #1
 Resin Regatta, SFYC – OC →
 High School Gold PCCs, StFYC – City →
 J/Fest, StFYC – City →
 Summer #1, SeqYC – SB
 Intraclub Race 1, RYC – CB
 Round the Rocks, SSS – CB
 Spring One Design #1, SCYC

18

PCISA Silver Championships, EYC – Estuary →
 Laser NorCal Regatta, SCYC →
YRA OYRA Lightship – Ocean
 Cal Cup #1, BYC – OC
 Intraclub, StFYC – City
 Anniversary Cup, SFYC – Knox
 Twin Island Race #1, SYC – Knox/Alcatraz
 Frostbite Series #5, ElkYC – Moss Landing

25

SUNDAY

Interconference Collegiate, StFYC – City

EASTER

5

Wheeler Regatta, BYC – OC/CB
 Baldwin, StFYC – City
 Harken Opti Challenge #2, SFYC – NC
 Big Dinghy, RYC – SH
 One Design Championship, CYC – Racoon
 Estuary Cup, EYC
 YRA 10/Alcaz/Estuary
 Spring Series #3, SSC – Stockton

12

YRA WBRA #1 – OC
 Resin Regatta, SFYC – OC
 High School Gold PCCs, StFYC – City
 J/Fest, StFYC – City
 Baxter/Judson #1, PresYC – West CB

19

PCISA Silver Championships, EYC – Estuary
 Laser NorCal Regatta, SCYC
 Spring Series #4, SSC – Stockton
 SCORE #1, SCYC

OPENING DAY ON THE BAY

26

Great Vallejo Race

Race to the Party



May 2 and 3
Season Opener for 116 Years

- Freshly Dredged Harbor
- Dance Floor Indoors Again
- Return of the Spaghetti Dinner
- First YRA-scored Race of the Year

www.VYC.org



YOUTH SAILING

continued from page 64

SAILING EDUCATION ADVENTURES (cont'd)

When: One-week sessions, June-August, M-F, noon-4 pm.

Boats: Catalina 16.5s, Lasers. Cost: \$325. Scholarships available.

SEA Explorers, ages 10-16, www.sfsailing.org/explorers
Intro to Sailing, Citizen Science, Bay Conservation.

Where: Loch Lomond Marina.

When: April, Sept., Sat-Sun., 9 am-4 pm.

Boats: Laser Picos, power boat trips. Cost: \$400/5 days. Scholarships available.

ST. FRANCIS YC (San Francisco)

Brent Harrill, (415) 820-3729, junior@stfyc.com, www.stfyc.com

Learn to Sail Program, ages 7-16

When: Saturday mornings, September-November and February-March.

Boats: Optimists, O'pen Bics, 420s (provided).

Cityfront Summer Sailing Camps, ages 7-16

When: June 29-July 3, July 20-24, August 10-14

Boats: Optimists, Lasers, Bytes, 420s, Bic Techno windsurfers (provided).

Tinsley Island Summer Overnight Sailing Camps, ages 8-15

When: June 15-August 7 (except Cityfront weeks)

Boats: Optimists, Lasers, Bytes, 420s, Bic Techno windsurfers (provided).

Learn to Windsurf Program, ages 8-16

When: Saturdays or Sundays, September-November and February-March.

Boards: Bic Techno 293 windsurfers (provided).

Introduction to Racing Program, ages 9-16

When: Sundays, September-November and February-March.

Boats: Optimists and 420s (provided).

Cost: Contact above.

SF MARITIME NATIONAL PARK

Seth Muir, (415) 292-6664, www.maritime.org

Maritime Park Association operates education programs to increase understanding of our nation's rich maritime heritage. Programs include daytime and environmental living programs at Hyde Street Pier.

The Age of Sail/Teacher Workshops:

The Gold Rush, Life on the Barbary Coast

Overnight Encampment on a Tall Ship

Educational Tours/Day Programs, Where History Meets Science, Educational Overnight Program and more programs aboard USS *Pampanito* submarine.

SFSU DEPT. OF REC., PARKS & TOURISM (Lake Merced, SF)

Barbara Enes, <http://recdept.sfsu.edu/sailing>

Summer Youth Sailing Camps, Paddling Camps, and Sailing & Science Camps, ages 8-15

When: June 16-August 15, M-F. Paddling Camp 9 am-noon; Sailing Camp 1-4 pm; Sailing & Science Camp 9 am-4pm.

Boats: Optis, JY 15s, double kayaks, SUPs (boats, boards & PFDs provided).

Cost: Half day week-long camps \$135-\$145; full day week-long Science Camp \$255. Scholarships for low-income groups are available (no individual scholarships provided).

SAN FRANCISCO YC (Belvedere)

Youth Office, (415) 435-9525, www.sfyc.org/youth

Summer Learn-to-Sail Program, ages 7-17

When: June-August. Boats: Optimists, JYs, FJs, J/24s (provided).

Race Teams, ages 8-18, all levels. When: All year.

High School Program, grades 9-12 from Marin Academy, Branson, or Redwood High School. When: September-May, Tuesday-Thursday, after school. Scholarships available through the Belvedere Cove Foundation.

SANTA CRUZ YC

Mary McKinnon-Tara, Junior Director, (831) 425-0690, www.scyc.org

El Toro Program, ages 8-14

Where: Pinto Lake, Watsonville. When: Sundays, September-March.

Boats: El Toros (some available for charter).

Cost: YC junior membership + program fee.

Scholastic Program, grades 8-12

Where: Santa Cruz Yacht Harbor.

continued on page 68

From the detailed assembly, finishing and unconventional thinking, Tylaska products provide sailors the ultimate in performance, strength & sailing pleasure.

Tylaska

DIVISION OF VECTOR ENGINEERING, INC.
MYSTIC, CT • MADE IN THE USA • (860) 572-8440

www.tylaska.com

MAY 2015

→ indicates 2-day races.
YRA events indicated in bold type.

● indicates full moon.

S	M	T	W	Th	F	S
					1	2
3	4	5	6	7	8	9
10	11	12	13	14	15	16
17	18	19	20	21	22	23
24	25	26	27	28	29	30
31						

WEEKDAY & SPECIAL EVENTS

- May 16-17:**
 - CYC Women's Sailing Seminar
- May 17:**
 - US Sailing-certified Safety at Sea Seminar, PCYC – EYC
- May 21-24:**
 - J/24 National Championships, BYC – OC
- May 22:**
 - Spinnaker Cup, SFYC/MPYC – Knox to Monterey
- May 25:**
 - Memorial Day
- May 29-31:**
 - Woodies Invitational, StFYC – City

SATURDAY

YRA Great Vallejo Race, VYC – CB/NB →
YRA WBRA Race #2
 Elvstrom Zellerbach, StFYC – City →
 Small Boat Races #2, EYC – Estuary
 Commodore's Cup, HMBYC – HMB
 Leukemia Cup, SCYC →
 South Bay Opening Day, SeqYC – SB

2

Mercury Series #3, EYC – Estuary
YRA OYRA Farallones Race – Ocean
 Single/Doublehanded #2, SeqYC – SB
 North Bay Series #2, VYC – NB
 Gromeekeo Round the Island, LGYC – CB
 Long Distance #2, SSC – Stockton
 Santana 22 Team Racing, SCYC
 South Bay Interclub #2, EYC – SB

9

Elite Keel/J/24 Westerns, SFYC – OC →
 Phyllis Kleinman Swiftsure, StFYC – City →
 Spring One Design #2/Moore 24 Regatta, SCYC →
 PICYA Youth Regatta, SeqYC, PYSF, BAYS – SB →
 Cal Cup #2, BYC – OC
 Women Skippers Race, SYC – Knox
YRA Spring #2
YRA WBRA Race #3
 Otter Cup, ElkYC – Moss Landing to Monterey/back
 Behrens Regatta, TYC – NB
 Singlehanded #1, SSC – Stockton

16

Master Mariners Regatta, SYC – City
 USMRC Qualifier, StFYC – City →
 Singlehanded Farallones, SSS – Ocean
 Championship #2, CYC – Knox

23

Perpetual Regatta, SBYC – SB/SF →
 Multihull Race, SCYC →
 Small Boat Races #3, EYC – Estuary
 Summer #2, SeqYC – SB
 Friendship Regatta, TYC/CYC – NB

30

SUNDAY

YRA Great Vallejo Race, VYC – CB/NB
 Frank Ballintine Memorial, CPYC – SB
 Elvstrom Zellerbach, StFYC – City
 Spring Series #5, SSC – Stockton
 Commodore's Cup Youth Regatta, HMBYC – HMB
 Leukemia Cup, SCYC

3

MOTHER'S DAY

10

Elite Keel/J/24 Westerns, SFYC – OC
 Phyllis Kleinman Swiftsure, StFYC – City
 Moore 24 Regatta, SCYC
 PICYA Youth Regatta, SeqYC/PYSF/BAYS – SB
 Spring Series #6, SSC – Stockton
 Baxter/Judson #2, PresYC – West CB

17

SCORE #2 Regatta, SCYC
 USMRC Qualifier, StFYC – City

24

Perpetual Regatta, SBYC – SB/SF
 Multihull Race, SCYC
 Spring Series #7, SSC – Stockton

31



Delta Ditch Run

June 6, 2015



The Delta Ditch Run starts in the San Francisco Bay and goes up the Delta, finishing at Stockton Sailing Club. In the past, the Delta Ditch Run has attracted over 200 boats with racers from across the country showing up for this generally downwind 65-mile race.

www.stocktonsc.org



FROM EL TOROS TO AMERICA'S CUP

David Liebenberg – 2014 National Champion



2015 EL TORO CLASS SCHEDULE

SENIOR:

RYC WINTER SERIES	1/4, 2/1, 3/1	STAMPEDE.....	10/11
LAKE MERRITT/ESTUARY	1/11, 2/14, 3/8	CORK SCREW	10/18
BULLSHIP	4/11	JUNIOR:	
FLIGHT OF THE BULLS	5/9	BIG DINGHY, RYC.....	4/11
FREMONT RELAYS	5/17	FREMONT SPRING	TBD
CLEAR LAKE	6/20-21	MAJORS CUP, LMSC.....	6/28
MAYOR'S CUP.....	6/28	SAIL CAMP, SSC.....	7/17
SANTA CRUZ NATIONALS	7/21-24	SANTA CRUZ NATIONALS	7/21-24
PINECREST	AUGUST & SEPTEMBER	FUN REGATTA, SCYC	AUGUST

91 Waldo Point S-40, Sausalito, CA 94965

www.eltoroyra.org • (415) 332-7269



TIBURON YACHT CLUB



Come join in on the fun and racing!

We are located on the east side of the Tiburon Peninsula at Paradise Cay Yacht Harbor, which offers ample docking and direct access from San Francisco Bay.

- 20 Beer Can Friday Night Races during the summer followed by informal dinners
- 17 Series and Special Event sailing races including a Women's Regatta
- Overnight cruises to Bay Area yacht clubs
- Theme parties with dining, music and dancing
- Monthly meetings feature programs of interest
- Club rentals for your special party
- Reasonable Dues

We have membership plans for everyone. Come and visit us!

For more information visit www.tyc.org

YOUTH SAILING

continued from page 66

SANTA CRUZ YC (cont'd)

When: Saturdays, September-March. Boats: CFJs.

Advanced Sailing Program, grades 8-12

Support for independent sailors with their own boats.

Boats: Lasers, 29ers, etc.

SAUSALITO YC

Renee Decurtis, coach@syccsailing.org,

www.sausalitoyachtclub.org/youth-sailing

Summer Program, all levels, ages 6-18

When: June-August. Boats: Optimists, Lasers, FJs, 420s.

Spring and Fall Program, ages 8-18

Boats: Optimists, FJs, 420s.

High School Sailing, Tamalpais HS, Marin School, www.tamsailing.com

When: Practice Tuesday-Friday; regattas weekends, Sept.-May. Varsity and JV teams. Scholarships available through Sausalito Youth Sailing Foundation.

SEA SCOUTS SAN FRANCISCO (Aquatic Park)

Dennis Lindemann (415) 585-8825, Tamara Sokolov, (415) 517-3943,

tamara.sokolov@gmail.com, www.corsair-viking.org

Year-Round Program, ages 13-18

When: Saturdays, 9:30 am-5 pm, Tuesdays, 5-8 pm, two-week, weekend and overnight cruises.

Boats: 30-ft sailing whaleboats, FJs, Cal 20s, more.

Cost: \$60/semi-annually.

SOUTH BEACH YC (San Francisco)

www.southbeachyc.org

Junior Program, ages 9-16

When: June-August, schedule TBD.

Boats: RS Teras, Lasers, FJs (provided).

Cost: \$295/week. Scholarships available for kids in need.

SPAULDING WOODEN BOAT CENTER (Sausalito)

(415) 332-3179, www.spauldingcenter.org

Sail on a Classic Wooden Boat: Cruises are offered for free to nonprofit groups serving youth, seniors and those who may not otherwise have the opportunity to experience the joy of sailing due to physical or financial constraints.

Spaulding Youth Boatbuilding Apprentice Program: Offers middle and high school students an apprenticeship in traditional boatbuilding and sailing. Apprentices learn woodworking skills and techniques in a working boatyard.

SPINNAKER YC (San Leandro)

(510) 351-7905, (510) 357-0601, www.spinnakeryc.org

Junior Program, ages 10-18, able to swim

When: M-F, 9 am-1 pm. One-week sessions beginning June 15; running through August 15. See website for sign-up details.

Boats: DeWitt Dinghies (provided).

Cost: \$225/San Leandro residents; \$250/non-residents.

STOCKTON SAILING CLUB

Susan Dallas, manager; Ross Alexander, harbormaster,

ross@stocktonsc.org, www.stocktonsc.org

Learn to Sail Program, ages 9-18

When: One-week classes, June-August.

Boats: Optis and FJs (provided).

Cost: Contact above; + \$15 short-term youth membership.

Summer Sleepover Sail Camp (with RYC & SCYC)

www.sailcamp.org

When: July 5-11. Boats: El Toros, Optimists (BYOB).

Cost: \$300 + one day of parent volunteer time. Scholarships available.

TAHOE COMMUNITY SAILING (Tahoe YC/Tahoe City)

Bryce Griffith, (530) 583-3440, ext. 11

Youth Sailing Program, ages 8-17

When: June-August, Monday-Thursday, 10 am-4 pm.

Race Program

Laser Radial and Pico Race Teams.

When: Monday evening and Friday day.

continued on page 70

JUNE 2015

→ indicates 2-day races.
YRA events indicated in bold type.

● indicates full moon.

S	M	T	W	Th	F	S
	1	2	3	4	5	6
7	8	9	10	11	12	13
14	15	16	17	18	19	20
21	22	23	24	25	26	27
28	29	30				

WEEKDAY & SPECIAL EVENTS

- June 3-4:**
 - Coastal Cup, EYC – SF to Santa Barbara
- June 13:**
 - Pacific Offshore Academy 1, POA #1, RYC
- June 18-21:**
 - Opti Heavy Weather, StFYC – City
- June 20:**
 - Summer Sailstice
- June 21:**
 - *Summer Solstice – Northern Hemisphere*
- June 23-25:**
 - Ripple Opti Clinic, CGRA
- June 23-26:**
 - Gorge Laser Performance Clinic, CGRA
- June 25-28:**
 - Long Beach Race Week, LBYC – Long Beach
- June 26-27:**
 - South Tower Race, SSC – Stockton-City-Stockton
- June 26-28:**
 - Team Race Invitational, StFYC – City
- June 27-28:**
 - Laser Masters NAs, CGRA

SATURDAY	SUNDAY
June Invitational, SFYC – OC → Ronstan Bay Challenge, StFYC – City → YRA OYRA #3 – Ocean Mercury Series #4, EYC – Estuary Merton Yolles Memorial Race, CPYC – SB North Bay Series #3, VYC – NB Delta Ditch Run, SSC – RYC to SSC <p style="text-align: right; font-size: 2em; font-weight: bold;">6</p>	June Invitational, SFYC – OC Ronstan Bay Challenge, StFYC – City Tri-Island #1, BYC – OC/Alcatraz <p style="text-align: right; font-size: 2em; font-weight: bold;">7</p>
Ken Gardiner Trophy, StFYC → Great SF Schooner Race, SFYC – Knox/Central YRA Spring Series #3 Jack and Jill, SSC – Stockton Santana 22 Team Racing, SCYC South Bay Interclub #3, OYC – SB <p style="text-align: right; font-size: 2em; font-weight: bold;">13</p>	Ken Gardiner Trophy, StFYC <p style="text-align: right; font-size: 2em; font-weight: bold;">14</p>
Opti Heavy Weather, StFYC – City → Spring One Design #3/505 Regatta, SCYC → Sailstice Small Boat Races, EYC – Estuary/SB X-Bay Regatta, SBYC/CYC – CB Cal Cup #3, BYC – East Circle Knarr Invitational, SYC, Knox Small Keelboat Series #2, SFYC – OC Hart Nunes, SFYC – Raccoon Strait Celebrate Summer Sailstice, ElkYC – Moss Landing Summer #3, SeqYC – SB H.O. Lind 1-2, TYC – NB Race of Champions, SSC – Stockton Intraclub Race #2, RYC – SH <p style="text-align: right; font-size: 2em; font-weight: bold;">20</p>	Opti Heavy Weather, StFYC – City 505 Regatta, SCYC Baxter/Judson #3, PresYC – West CB <p style="text-align: right; font-size: 2em; font-weight: bold;">21</p>
Small Boat Races #4, EYC – Estuary Silver Eagle, IYC – CB Rear Commodore Race, SYC – Knox to SB Bay YRA OYRA Half Moon Bay – Ocean <p style="text-align: right; font-size: 2em; font-weight: bold;">27</p>	FATHER'S DAY <p style="text-align: right; font-size: 2em; font-weight: bold;">21</p>
	PICYA Lipton Cup, OYC – SB SCORE #3 Regatta, SCYC <p style="text-align: right; font-size: 2em; font-weight: bold;">28</p>

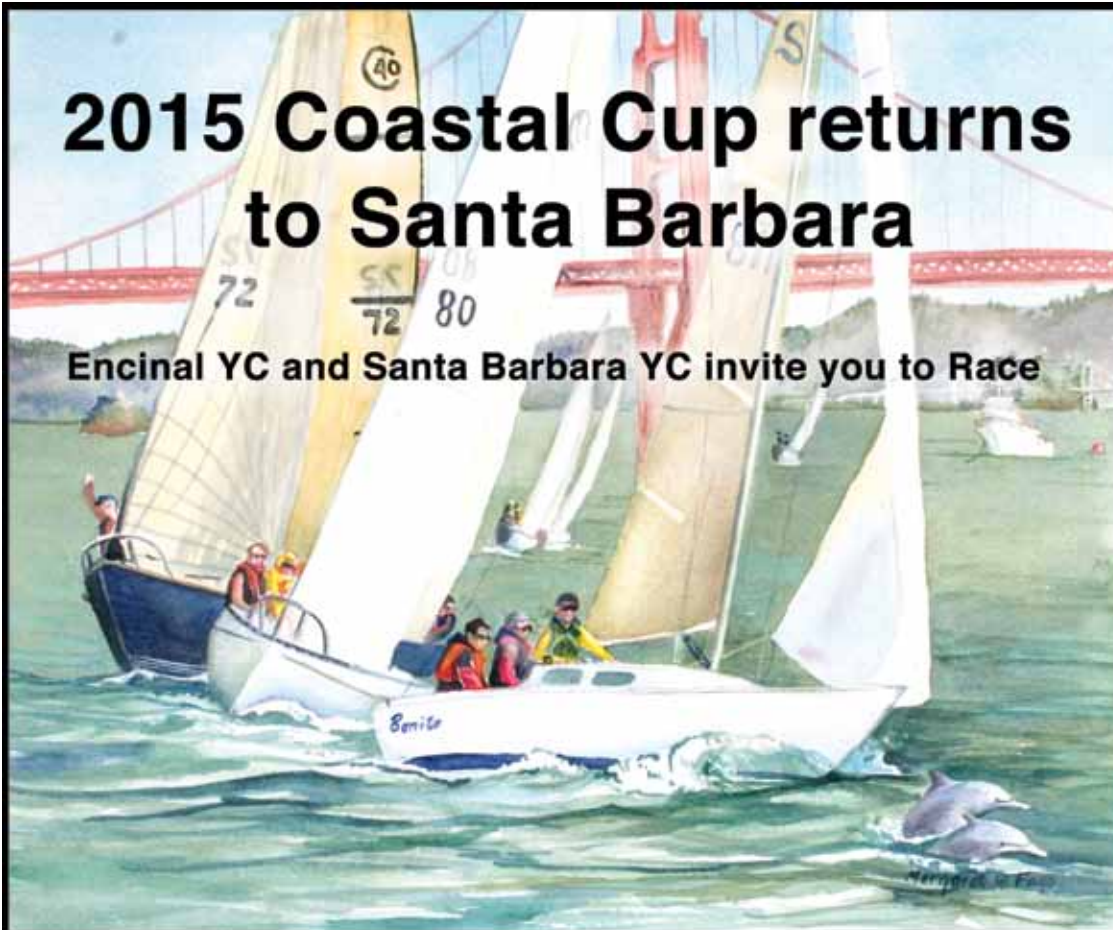

2015 Coastal Cup returns to Santa Barbara

Encinal YC and Santa Barbara YC invite you to Race



Coastal Cup Start:
 San Francisco
 June 3 & 4 2015



Awards Party:
 SBYC June 6
 Beach BBQ

Stay to race:
 Long Beach Race
 Week June 26-28

Transpac July 13

Information:
www.encinal.org

Boat & Yacht Insurance

Call NOW for a money saving new quote



Since 1959
www.marinersins.com
Ins. Lic. #0D36887



In the Bay Area Contact
Carolyn Pounds
(800) 992-4443 ext. 112
(510) 254-3689
carolyn@marinersins.com

Newport Beach, CA San Francisco, CA San Diego, CA Seattle, WA Bradenton, FL

YOUTH SAILING

continued from page 68

TAHOE COMMUNITY SAILING (cont'd)

Boats: CFJs, Picos, Nomad 17s, Lasers, 420s.

US Sailing Power Boat Safe Boat Handling ADVENTURE SAILING/AQUATICS

Sailing, paddle boarding, environmental ecology, water safety.
Cost: Contact above.

TREASURE ISLAND SAILING CENTER

Chris Childers, (415) 421-2225, www.tisailing.org

Harbor Seals Adventure Program, age 6

When: Sundays, 1pm-4pm.

Spring Session: April 5, 12, 19, 26; May 3, 10, 17, 24.

Fall Session: September 6, 13, 20, 27; October 4, 11, 18, 25

Spring and Fall Youth Sailing Lessons, all skill levels, ages 7-13

When: Sundays in spring and fall, 9:30 am-12:30 pm.

Spring session: April 5, 12, 19, 26; May 3, 10, 17, 24.

Fall Session: September 6, 13, 20, 27; October 4, 11, 18, 25

Cost: \$300 per session.

Optimist and FJ Race Team, advanced sailors only, ages 7-13

When: Sundays in spring and fall, 1-4 pm, plus regattas Saturdays and Sundays.

Cost: \$350 (with separate regatta fees to be paid to the host club).

Spring Session: April 5, 12, 19, 26; May 3, 10, 17, 24.

Fall Session: September 6, 13, 20, 27; October 4, 11, 18, 25

Midweek Sailing Class, all skill levels, ages 7-13

When: Tuesdays in the spring and fall, 4 pm-7 pm.

Spring Session: April 7, 14, 21, 28; May 5, 12, 19, 26

Fall Session: September 8, 15, 22, 29; October 6, 13, 20, 27

Summer Sailing Camp, all skill levels, ages 6-18

When: One or two-week sessions, full or half day classes avail., June-August.

Full Day Camp: M-F, 9 am-4 pm; half day camp: M-F, 9 am-12:15 pm.

Boats: FJs, Bugs, Optimists, Ventures, J/24s (provided); PFDs, wetsuits and foul weather gear also provided.

Cost: Full Day Camp: \$350/one-week session or \$600/two-week session; extended care 8:30 am-5 pm, \$40/week.

Cost: Half Day Camp: \$200/one-week session or \$350/two-week session; extended care 8:30 am-1 pm, \$40/week.

Note: Sessions that coincide with 4th of July have slightly reduced fees.

Partial or full scholarships available for all classes.

PACIFIC COAST INTERSCHOLASTIC SAILING ASSOCIATION (PCISA) EVENTS FOR HIGH SCHOOL SAILORS

- January 3-4:** Rose Bowl, PCISA 3/5, USSC/LB
- January 10:** NorCal #6 Gold, RYC
- January 10:** SoCal #3, MBYC
- January 10:** NorCal #6 Silver, RYC
- January 18-19:** SCYA Harold Adams Team Race, SDYC
- January 31:** SoCal #4, ABYC
- February 7:** NorCal #7, HMBYC
- February 8:** NorCal #8, HMBYC
- February 21-22:** Golden Bear Regatta, TISC
- February 28:** NorCal #9, LWSC
- March 14-15:** Gaucho Regatta, SBYC
- March 21-22:** NorCal Championship, SFYC
- March 28:** SoCal #5, SDYC
- April 9-12:** CISA Advanced Race Clinic, ABYC
- April 18-19:** Gold Pacific Coast Championship, StFYC
- April 18-19:** Silver Pacific Coast Championship, CBYC
- April 25-26:** Team Race Pacific Coast Championship, SDYC
- May 8-10:** Mallory Trophy ISSA Fleet Race Championship, MASSA
- May 22-24:** Baker Trophy ISSA Team Race Championship, MISSA
- Sept.-Dec.:** 2015 Fall Schedule TBA; see www.pcisa.org

NATIONAL YOUTH EVENTS

See www.ussailing.org for US Sailing info and dates.

FAST, LIGHT, EFFICIENT

Outboard Motor Shop has the power you need to get to or from the race course!

HONDA MARINE



- 2 to 350 horsepower
- As low as 29.5 lbs engine weight!
- 5-year warranty

© 2015 American Honda Motor Co., Inc.

Always wear a personal flotation device while boating and read your owner's manual. 5-year warranty standard on all new Honda outboard engines purchased. Check with participating dealers for complete details.

Outboard Motor Shop

Where the professionals shop!

(510) 533-9290

www.outboardmotorshop.com

333 Kennedy St., Oakland, CA 94606 • Fax 510-533-3374

JULY 2015

→ indicates 2-day races.

YRA events indicated in bold type.

● indicates full moon.

S	M	T	W	Th	F	S
			1	2	3	4
5	6	7	8	9	10	11
12	13	14	15	16	17	18
19	20	21	22	23	24	25
26	27	28	29	30	31	

WEEKDAY & SPECIAL EVENTS

- July 4:** • Independence Day
- July 6-9:** • WIND Youth Laser Clinic/Regatta, CGRA – Cascade Locks, OR
- July 6-23:** • Laser Performance Clinic/Blowout, CGRA – Cascade Locks, OR
- July 10-12:** • J/70 PCCs, StFYC – City
- Melges 24 Summer Sportboat Regatta, StFYC
- July 15-16:** • 29er Pre-Regatta Racing Clinic, CGRA
- July 17-19:** • Santana 22 Nationals, CYC – Knox
- SC27 Nationals, SCYC – in conjunction with Santa Barbara YC's Fiesta Cup Regatta
- 29er NAs, CGRA
- June 18-19:** • SF Bay Classic & UN Challenge, StFYC
- July 21-24:** • El Toro North Americans, SCYC
- July 22-25:** • 29er Nationals, RYC – SH
- July 31-Aug 2:** • Kiteboard Invitational, StFYC – City
- Columbia Gorge One-Design Regatta (CGOD), CGRA

SATURDAY	SUNDAY
Independence Cup, SFYC – Knox Stars and Stripes, CPYC – SB Brothers & Sisters Race, TYC – NB Firecracker Race, ElkYC – Moss Landing to Monterey & back	
BAYS Svendsen's Summer Splash, EYC – Estuary → J/105s+ Regatta, SYC – CB → SF Cup/Catalina 34 Fleet, SBYC – SB → YRA Summer Series #1 Small Boat Races #5, EYC – Estuary Midnight Moonlight Maritime Madness, SFYC – Raccoon to Carquinez & Return North Bay #4, VYC – NB Championship Series #3, CYC – Knox Jack and Jill Race, SSC – Stockton Santana 22 Team Racing, SCYC South Bay Interclub #4, SBYC – SB	BAYS Svendsen's Summer Splash, EYC – Estuary J/105s+ Regatta, SYC – CB SF Cup/Catalina 34 Fleet, SBYC – SB Tri-Island Race #2, BYC – OC/TI
SF Classic & UN Challenge, StFYC – City → 505 Regatta, SCYC → Twin Island Race #2, SYC – Knox/Alcatraz YRA Westpoint Regatta – SB 31st Annual Plastic Classic, BVBC – SB/SF Moseley Regatta, TYC – NB Singlehanded #2, SSC – Stockton Sailor's Choice Summer Mini Series #1, SeqYC	SF Classic & UN Challenge, StFYC – City 505 Regatta, SCYC Baxter/Judson #4, PresYC – West CB
Mitchell/Ross Regatta, SFYC – Knox YRA OYRA #5 – Ocean Single/Doublehanded #3, SeqYC – SB One Design Invitational, CYC – OC → H.O. Lind 3-4, TYC – NB	Sir Francis Chichester Race, EYC – SB/Estuary One Design Invitational, CYC – OC

31st Annual

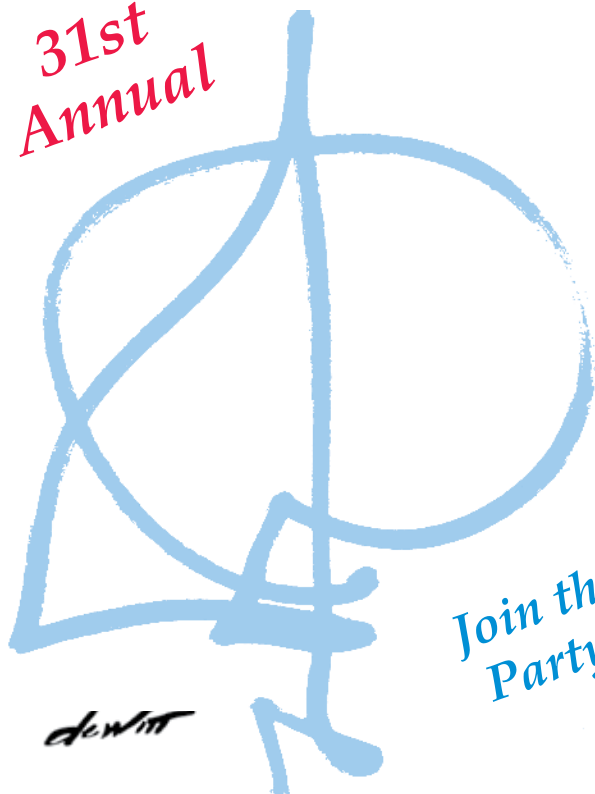

Join the Party!

THE BAY VIEW BOAT CLUB AND THE ISLANDER BAHAMA FLEET invite all

'60s, '70s & '80s Vintage Fiberglass Sailboats

to the San Francisco

PLASTIC CLASSIC

REGATTA

and

Concours d'Elegance

Saturday, July 18

at the Bay View Boat Club and the waters of Pier 54.

Visit our website: www.bvbc.org

Bay View Boat Club, 489 Terry Francois Blvd., San Francisco, CA 94158

www.plasticclassic.com

NEW



OPENING PRE-FEEDER

The new Schaefer opening pre-feeders solve many issues on the bow of any racing sailboat. Our two sizes cover boats in all ranges. The 45-06 is our non-adjustable opening pre-feeder with a computer machined finish for a smooth entry. The single pull opening feature allows for quick disengagement. Our 45-07 Grand Prix design allows the flexibility to adjust for various luff tape sizes from #5 through #8.

SCHAEFER
LEGENDARY STRENGTH

508.995.9511
SCHAEFERMARINE.COM

Robichaud Batten Systems USA



Quality.
Durability.
Performance.



Trusted and preferred by
these Bay Area Sail Makers:

North Sails Quantum Sails
Pineapple Sails Doyle Sails
Hogin Sails Santa Cruz Sails
UK-Halsey Sails Pegasus Racing

Visit us at www.rbsbattens.com for
more info on new products.

LAKE CIRCUIT

All the flavor of saltwater sailing in a low-sodium package! Beer can series details can be found on pages 20-24.

JANUARY

Thursday, January 1

Frostbite Regatta, LYSA – Lake Yosemite, Merced
Linda Sorensen, wannie1957@yahoo.com
www.lakeyosemitesailing.org

Sunday, January 11

Robinson Midwinter #2, LMSC – Lake Merritt
Mark Marlett, (925) 245-0287

Saturday, January 24

Winter Series, SRSC – Spring Lake, Santa Rosa
Mark Alarie, www.santarosasailingclub.org

FEBRUARY

Saturday, February 7

Spring Series #1, FLYC – Folsom Lake
www.flyc.org

Saturday, February 14

Robinson Midwinter #3, LMSC – Lake Merritt
Mark Marlett, (925) 245-0287

Saturday, February 21

Winter Series, SRSC – Spring Lake, Santa Rosa
Mark Alarie, www.santarosasailingclub.org

Spring Series #2, FLYC – Folsom Lake
www.flyc.org

MARCH

Saturday, March 7

Spring Series #3, FLYC – Folsom Lake
www.flyc.org

Sunday, March 8

Robinson Midwinter #4, LMSC – Lake Merritt
Mark Marlett, (925) 245-0287

Saturday, March 21

Spring Series #4, FLYC – Folsom Lake
www.flyc.org

Saturday, March 28

Spring Series #5, FLYC – Folsom Lake
www.flyc.org

Frostbite, KBSC – Clear Lake
Brad King, chezking@att.net, info@kbsail.com
www.kbsail.com

APRIL

Saturday, April 4

Trans-Folsom, FLYC – Folsom Lake
www.flyc.org

Saturday, April 11

Summer Series #1, KBSC – Clear Lake
Brad King, chezking@att.net, info@kbsail.com,
www.kbsail.com

Saturday-Sunday, April 18-19

Camellia Cup, FLYC – Folsom Lake
www.flyc.org

Saturday, April 25

Konocti Cup, KBSC – Clear Lake
Brad King, chezking@att.net, info@kbsail.com
www.kbsail.com

continued on page 74

AUGUST 2015

→ indicates 2-day races.
YRA events indicated in bold type.

● indicates full moon.

S	M	T	W	Th	F	S
						1
2	3	4	5	6	7	8
9	10	11	12	13	14	15
16	17	18	19	20	21	22
23	24	25	26	27	28	29 ●
30	31					

WEEKDAY & SPECIAL EVENTS

- July 31-Aug 2:**
- Kiteboard Invitational, StFYC – City
 - Columbia Gorge One Design, CGRA – Cascade Locks, OR
- August 6-9:**
- Melges 24 US Nationals, CGRA
- August 14-16:**
- Laser Master Nationals, StFYC
- August 15:**
- Double Damned, HRYC – Cascade Locks to the Dalles, OR
- August 21-23:**
- Aldo Alessio Regatta, StFYC – City
- August 24-29:**
- 18-ft Skiff Regatta, StFYC – City
- August 27:**
- Ronstan Bridge to Bridge, StFYC – City
- August 28-30:**
- O'pen Bic Gorge Sailing Camp, CGRA

SATURDAY

YRA 2nd Half Opener – CB/SB →
 One-Design Championships, BYC – OC →
 Multihull Regatta, SFYC – North OC →
 Kay & Dave Few Regatta, CPYC – SB
YRA WBRA #4
 North Bay Series #5, VYC – NB
 Sailor's Choice Summer Mini Series #2,
 SeqYC – Moss Landing

1

Albert T. Simpson, StFYC – City →
 BAYS #4 Youth Regatta, SFYC – Richardson Bay →
 Big Brothers Big Sisters Regatta, SCYC →
YRA Summer Series #2
 Small Keelboat Series #3, SFYC – North OC
 Overnight Race, SSC – Stockton
 Santana 22 Team Racing, SCYC
 South Bay Interclub #5, BAMA – SB

8

Summer Keel/Melges, SFYC – North OC →
 Knarr Invitational, SYC →
YRA WBRA #5
 Cal Cup #4, BYC – OC
 Summer #4, SeqYC – SB
 Fox Hat Race, TYC – NB
 Championship Series #4, CYC – Knox
 Sailor's Choice Summer Mini Series #3,
 SeqYC – Moss Landing
 Fall One Design #1 (incl. 505), SCYC

15

Special Olympics NorCal Regatta, BYC – OC/CB →
 Knarr Invitational (alt. wknd), SYC →
YRA OYRA Drake's Bay I – Ocean →
 Small Boat Races #6, EYC – Estuary
 Single/Doublehanded #4, SeqYC – SB
 Double Angle, ElkYC – Santa Cruz/Monterey Bay
 Round the Rock, BVBC – SB/SF
 H.O. Lind 5-6, TYC – NB
 Intraclub Race #3, RYC – SH

22

Wosser Cup, SFYC – Knox
 Moonlight Marathan, SeqYC – SB/TI

29

SUNDAY

YRA 2nd Half Opener – CB/SB →
 One-Design Championships, BYC – OC
 Multihull Regatta, SFYC – Knox

2

Albert T. Simpson, StFYC – City
 BAYS #4 Youth Regatta, SFYC – Richardson Bay
 Big Brothers Big Sisters Regatta, SCYC
 Tri-Island Race #3, BYC, OC/Angel

9

Summer Keel/Melges, SFYC – North OC
 Knarr Invitational, SYC
 Baxter/Judson #5, PresYC – West CB

16

Special Olympics NorCal Regatta, BYC – OC/CB
 Knarr Invitational (alt. wknd), SYC
YRA OYRA Drake's Bay II – Ocean
 Gracie & George Regatta, EYC – SB/Estuary
 Fall SCORE #1 Regatta, SCYC

23

30

South Beach Yacht Club 2015 Racing Season



**For the best sailing
 on the South Bay,
 come race with SBYC!**

All Boats Welcome

One Design Starts Available
 (minimum entry requirements)

Post-race activities include BBQ & no-host bar.
 Prizes awarded for all divisions.

For race information contact:
rearcommadore@southbeachyachtclub.org

or visit our Web site at:

www.southbeachyachtclub.org

South Beach Yacht Club
 Pier 40 on the Embarcadero
 San Francisco



2015 Island Fever Races:
1/17, 2/21, 3/21, 11/21, 12/19

Friday Night Series: April 17–September 11

NEW SBYC Perpetual Regatta: May 30-31
SBYC/CYC X-Bay Regatta: June 20

Jazz Cup: September 5

Red Bra Regatta: October 3



Come on up and enjoy the

51st Annual

Memorial Regatta

May 23 & 24, 2015

Whiskeytown Sailing Club

Whiskeytown Lake, Redding, CA

All Fleets Are Welcome –

Dinghies • Centerboard • Multihull • Keel boats

“Good Racing, Fresh Water, Great Food and Lots of Good People.”

Entry or information:

www.whiskeytownsailing.org

(530) 539-4471

whiskeytownsailing@gmail.com

Bay Area Contact:

PRO John Super (415) 564-4779 • johnhsuper@att.net

Membership info on WSC web site. WSC is a Member Club of SF-YRA

LAKE CIRCUIT

continued from page 72

MAY

Saturday, May 2

Opening Day, LYSA – Lake Yosemite, Merced
www.lakeyosemitesailing.org

Wednesday, May 6

Beer Can Series begins, FLYC – Folsom Lake
www.flyc.org
See p. 22 for details and complete schedule.

Thursday, May 7

Beer Can Races begin, LYSA – Lake Yosemite, Merced
See p. 22 for details and complete schedule.

Saturday, May 9

Flight of the Bulls, Lake Elizabeth, Fremont
www.eltoroyra.org

Summer Series #2, KBSC – Clear Lake
Brad King, chezking@att.net, info@kbsail.com
www.kbsail.com

Friday, May 15

Summer Sunset Series begins, FLYC – Folsom Lake
See p. 22 for details and complete schedule.

Saturday, May 16

Lady and the Tramp Race, FLYC – Folsom Lake
www.flyc.org

Saturday-Sunday, May 16-17

Spring Regatta, LYSA – Lake Yosemite, Merced
Jerry Johnson, (559) 776-9429,
wannie1957@yahoo.com, www.lakeyosemitesailing.org

Sunday, May 17

Fremont Relays, Lake Elizabeth, Fremont
www.eltoroyra.org

Wednesday, May 20

Beer Can Races begin, LTWYC – Tahoe South Shore
See p. 22 for details and complete schedule.

Saturday, May 23

Monster Race, KBSC – Konocti Bay to Lakeport
Brad King, chezking@att.net, info@kbsail.com
www.kbsail.com

Saturday & Sunday, May 23-24

Whiskeytown Memorial Regatta, WSC – Whiskeytown
www.whiskeytownsailing.org

Wednesday, May 27

Beer Can Spring Series begins, Tahoe YC – Lake Tahoe
See p. 24 for details and complete schedule.

JUNE

Monday, June 1

Laser Spring Series begins, Tahoe YC – Lake Tahoe
See p. 26 for details and complete schedule.

Saturday & Sunday, June 6-7

Go for the Gold Regatta, GCYC – Scotts Flat Lake
www.gyc.net

Sunday, June 7

Beer Can Series #1, KBSC – Clear Lake
See p. 22 for details and complete schedule.

continued on page 76

GRAND MARINA

FULL SERVICE MARINE CENTER



510.865.1200
2099 Grand Street
Alameda, CA 94501
grandmarina.com



SEPTEMBER 2015

● indicates full moon.

S	M	T	W	Th	F	S
		1	2	3	4	5
6	7	8	9	10	11	12
13	14	15	16	17	18	19
20	21	22	23	24	25	26
27	28	29	30			

→ indicates 2-day races. **YRA events indicated in bold type.**

WEEKDAY & SPECIAL EVENTS	SATURDAY	SUNDAY
<p>September TBD:</p> <ul style="list-style-type: none"> • Latitude 38 Mexico-Only Crew List Party, 6-9 pm. For date and location, see Latitude 38 or www.latitude38.com. 	<p>Redwood Regatta, HYC – Big Lagoon → Jazz Cup, SBYC/BYC – CB to Benicia North Bay Series #6, VYC – NB Fall Series #1, SSC – Stockton</p> <p style="text-align: right;">5</p>	<p>Redwood Regatta, HYC – Big Lagoon</p> <p style="text-align: right;">6</p>
<p>September 4:</p> <ul style="list-style-type: none"> • Windjammers, StFYC/SCYC – SF to Santa Cruz <p>September 6-12:</p> <ul style="list-style-type: none"> • Folkboat Internationals, CYC – Knox <p>September 7:</p> <ul style="list-style-type: none"> • <i>Labor Day – Take a worker sailing</i> 	<p>Millimeter Nationals #1, EYC – Estuary → Easom Founders/Etchells PCCs, SFYC – North OC → West Marine Fun Regatta, SCYC → YRA Summer Series #3 SH/DH #5/Commodore's Cup, SeqYC – SB Tornberg Regatta, TYC – NB South Bay Interclub #6, IYC – SB</p> <p style="text-align: right;">12</p>	<p>Millimeter Nationals #2, EYC – Estuary Easom Founders/Etchells PCCs, SFYC – North OC West Marine Fun Regatta, SCYC Commodore's Cup, EYC – Estuary Governor's Cup Series #2, FLYC – Folsom Lake</p> <p style="text-align: right;">13</p>
<p>September 17-20:</p> <ul style="list-style-type: none"> • Rolex Big Boat Series, StFYC – City <p>Sept. 17, 24-26:</p> <ul style="list-style-type: none"> • J/22 Stag Cruise, StFYC – City <p>September 19-20:</p> <ul style="list-style-type: none"> • Women's Sailing Seminar, IYC – Estuary <p>September 23:</p> <ul style="list-style-type: none"> • <i>Autumnal Equinox</i> 	<p>Totally Dinghy, RYC – SH → Fall One Design #2/505s, SCYC → YRA OYRA Race #8 – Ocean Small Boat Races #7, EYC – Estuary Barth Race/Interclub Challenge, CPYC/SeqYC – SB Cal Cup #5, BYC – OC SSS Half Moon Bay</p> <p style="text-align: right;">19</p>	<p>Totally Dinghy, RYC – SH 505s, SCYC Governor's Cup Series #3, FLYC – Folsom Lake Women's Sailing Seminar Regatta, IYC – Estuary Jack & Jill Regatta, SCYC</p> <p style="text-align: right;">20</p>
<p>Sept. 24-27:</p> <ul style="list-style-type: none"> • J/70 North Americans, SDYC – San Diego <p>Sept. 28-29:</p> <ul style="list-style-type: none"> • Melges 20 Pre-Worlds, SFYC – OC <p>September 29:</p> <ul style="list-style-type: none"> • Sunset Championship, SYC <p>Sept. 30-Oct. 3:</p> <ul style="list-style-type: none"> • Melges 20 World Championships, SFYC – OC 	<p>Express 37 National Championship, BYC – OC/CB → YRA Season Closer – CB → Herb Meyer Regatta, SBYC – SB/SF → Multihull Regatta, RYC – SH → Summer Series #5, SeqYC – SB YRA WBRA #6 Champions Race, BenYC – Carquinez</p> <p style="text-align: right;">26</p>	<p>Express 37 National Championship, BYC – OC/CB YRA PC Season Closer – CB/Bonita Herb Meyer Regatta, SBYC – SB/SF Multihull Regatta, RYC – SH Champion of Champions, BVBC – SB/SF Baxter/Judson #6, PresYC – West CB Fall SCORE #2 Regatta, SCYC Vice Commodore's Youth Regatta, HMBYC – HMB</p> <p style="text-align: right;">27</p>

BOAT LOANS

from

Trident Funding

"a fresh approach from people you can trust"

JOAN BURLEIGH
(800) 690-7770

Berkeley Yacht Club Oktoberfest Regatta 2015



LAKE CIRCUIT

continued from page 74

Saturday, June 13

Katherine Eavenson Regatta, FLYC – Folsom Lake
www.flyc.org

NTRR, Tahoe YC – Lake Tahoe
Dan Hauserman, (530) 581-4700, dan@ilovetahoe.com
www.tahoeyc.com

Around the Pins, LTWYC – South Lake Tahoe
Kurt Rasmussen, (530) 307-0903, ltwyc2@aol.com
www.tahoewindjammers.com

Saturday-Monday, June 13-15

El Toro Nationals, KBSC – Clear Lake
www.kbsail.com

Saturday, June 20

Summer Series #3, KBSC – Clear Lake
Brad King, chezking@att.net, www.kbsail.com

Saturday-Sunday, June 20-21

El Toro Nationals, KBSC – Clear Lake
www.eltoroyra.org

Commodore's Regatta, FYC – Huntington Lake
fresnoyc@gmail.com, www.fresnoyachtclub.org

Saturday, June 27

3 Island Fiasco, KBSC – Clear Lake
Brad King, chezking@att.net, info@kbsail.com
www.kbsail.com

Southern Crossing, LTWYC – South Lake Tahoe
Kurt Rasmussen, (530) 307-0903, ltwyc2@aol.com
www.tahoewindjammers.com

Sunday, June 28

Mayor's Cup, LMSC – Lake Merritt
Mark Marlett, (925) 245-0287

JULY

Wednesday, July 1

Intergalactic Beer Can Race, LTWYC – South Lake Tahoe
Kurt Rasmussen, (530) 307-0903, ltwyc2@aol.com
www.tahoewindjammers.com

Friday, July 10

Trans Tahoe Warm-up Race, Tahoe YC – Lake Tahoe
Dan Hauserman, (530) 581-4700, dan@ilovetahoe.com
www.tahoeyc.com

Thursday-Saturday, July 10-12

Melges Race Week, Tahoe YC – Lake Tahoe
Dan Hauserman, (530) 581-4700, dan@ilovetahoe.com
www.tahoeyc.com

Saturday, July 11

Trans Tahoe Race, Tahoe YC – Lake Tahoe
Dan Hauserman, (530) 581-4700, dan@ilovetahoe.com
www.tahoeyc.com

Saturday & Sunday, July 11-12

High Sierra Centerboard Divisions, FYC – Huntington Lake
fresnoyc@gmail.com, www.fresnoyachtclub.org

Sunday, July 12

Howard Stevens Race, LTWYC – South Lake Tahoe
Kurt Rasmussen, (530) 307-0903, ltwyc2@aol.com
www.tahoewindjammers.com

continued on page 78

WINDEX INNOVATION

WINDEX[®] 15

with Bird-Proof Spike!

Why Windex 15 is the choice for most sailors:

- 15" wind vane (38 cm)
- Sapphire suspension bearing
- Adjustable tacking arms with tabs
- Vane and tabs feature reflectors for high visibility day and night.
- Weighs just 3.9 ounces (111 grams)
- Stands 12.75" tall (32 cm)
- Bird-proof spike extends another 10" (24 cm) above vane to discourage birds from landing.

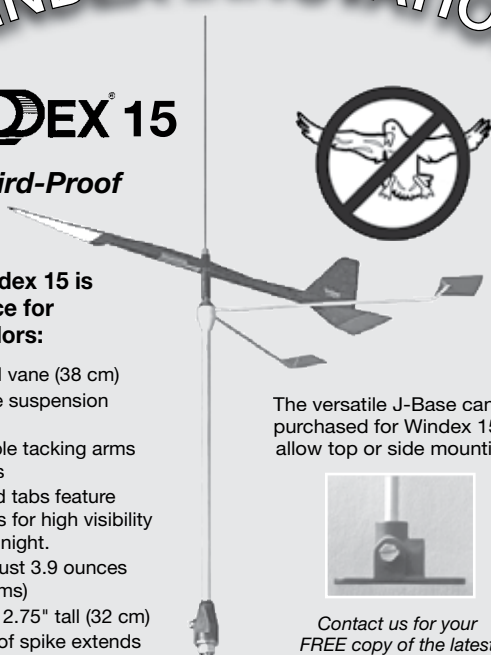

The versatile J-Base can be purchased for Windex 15 to allow top or side mounting.



Contact us for your **FREE** copy of the latest **DAVIS** catalog

Davis Instruments 3465 Diablo Ave., Hayward, CA 94544 USA
Phone 800-678-3669 • Fax 510-670-0589 • Email info@davisnet.com

www.davisnet.com

OCTOBER 2015

→ indicates 2-day races.

YRA events indicated in bold type.

● indicates full moon.

S	M	T	W	Th	F	S
				1	2	3
4	5	6	7	8	9	10
11	12	13	14	15	16	17
18	19	20	21	22	23	24
25	26	27	28	29	30	31

WEEKDAY & SPECIAL EVENTS

- Sept. 30-Oct. 3:** • Melges 20 North Americans, SFYC – North OC
- October TBD:** • Express 27 Nationals, CYC – OC
- October 2-4:** • Cornerstone Cup, StFYC – City
- October 12:** • *Columbus Day*
- October 17:** • Pacific Offshore Academy 2, POA #2, RYC
- October 21-23:** • Killroy Pro Am, StFYC – City
- October 26:** • Baja Ha-Ha starts, SD-Cabo
- October 31:** • *Halloween: Go sailing in costume!*

SATURDAY

YRA OYRA Race #9, BYC – Ocean
 Jerry O'Grady SH Race, CPYC, SB
 Oktoberfest, OYC – TI/Estuary
 Red Bra Regatta, SBYC – SB/SF side
 Shorthanded Races, TYC – NB

3

Fall Classic, SFYC – Knox →
 Fall Series #2, SSC – Stockton
 Intraclub Race #4, RYC – SH
 Chowder Cup #1, ElkYC – Moss Landing
 Santana 22 Team Racing, SCYC

10

BAYS NorCal HS Pumpkin Regatta, EYC – Estuary →
 Joe Logan/Calvin Paige, StFYC – City →
 Vallejo 1, SSS →
 Oktoberfest, BYC – OC
 Jessica Cup, StFYC – City
 Twin Island Race #3, SYC – Knox/Alcatraz
 Challenge Race, SeqYC – SB
 Fall Shorteez Regatta; PHRF 180>, CPYC – SB
 Joan Storer Regatta, TYC – NB
 Ross Wood CC #5, CYC – Knox
 Fall One Design #3, SCYC

17

Fall Dinghy, StFYC – City →
 Great Pumpkin, RYC – OC →
 Round the Island, SFYC – Belvedere/TI/SH
 Corkscrew Slough Regatta, SeqYC – SB
 South Bay Championship, SeqYC – SB
 Chowder Cup #2, ElkYC – Moss Landing

24

Red Rock Race, TYC – NB

31

SUNDAY

Chowder #1, BYC – OC
 Predicted Log Race, SCYC

4

Fall Classic, SFYC – Knox
 Chowder #2, BYC – OC
 El Toro Stampede, RYC – Pt. Potrero Reach

11

BAYS NorCal HS Pumpkin Regatta, EYC – Estuary
 Joe Logan/Calvin Paige, StFYC – City
 Vallejo 2, SSS
 Chowder #3, BYC – OC
 Leukemia Cup, SFYC – Knox
 Invitational Challenge, LGYC – SB
 Ladies Skippers Regatta, PresYC – West CB

18

Fall Dinghy, StFYC – City
 Great Pumpkin, RYC – OC
 Chowder #4, BYC – OC
 Fall SCORE #3 Regatta, SCYC

25

IT STARTS WITH A FIASCO, AND COULD TAKE YOU TO HAWAII



SHORTHANDED SAILING IN THE BAY AND THE OCEAN

The Singlehanded Sailing Society has the ideal progression to help you meet the challenge.....

2015 Race Dates:

Three Bridge Fiasco - Jan. 31
 Corinthian - Mar. 21
 Round the Rocks - Apr. 18

① Singlehanded Farallones - May 23
 56-mile Qualifier for the LONGPAC

② Great Pacific Longitude Race - "Longpac" - July 9
 400-mile Qualifier for SHTP

Drake's Bay - Aug. 22-23
 Half Moon Bay - Sept. 19
 Vallejo 1-2 - Oct. 17-18

③ Singlehanded Transpac - June 2016
 2,120 miles. Ends in Hanalei Bay, Kauai



JOIN US IN 2015!

Complete SSS schedule: www.sfbaysss.org

LAKE CIRCUIT

continued from page 76

Sunday, July 12 (cont'd)

Summer Series #4, KBSC – Clear Lake
Brad King, chezking@att.net, info@kbsail.com
www.kbsail.com

Saturday & Sunday, July 18-19

High Sierra Keelboat Divisions, FYC – Huntington Lake
fresnoyc@gmail.com, www.fresnoyachtclub.org

Saturday, July 25

Centerboard Regatta, FLYC – Folsom Lake
www.flyc.org

Sadie Hawkins Race, KBSC – Clear Lake
Brad King, chezking@att.net, info@kbsail.com
www.kbsail.com

Saturday & Sunday, July 25-26

Mercury Regatta, FYC – Huntington Lake
fresnoyc@gmail.com, www.fresnoyachtclub.org

Sunday, July 26

Doublehanded Races, LTWYC – South Lake Tahoe
Kurt Rasmussen, (530) 307-0903, ltwyc2@aol.com
www.tahoewindjammers.com

AUGUST

Saturday & Sunday, August 1-2

Hobie Mile High Regatta, FYC – Huntington Lake
fresnoyc@gmail.com, www.fresnoyachtclub.org

Sunday, August 2

Commodore's Cup, LTWYC – South Lake Tahoe
Kurt Rasmussen, (530) 307-0903, ltwyc2@aol.com
www.tahoewindjammers.com

Saturday, August 8

Summer Series #5, KBSC – Clear Lake
Brad King, chezking@att.net, info@kbsail.com
www.kbsail.com

Sunday, August 9

Ladies' Day Races, LTWYC – South Lake Tahoe
Kurt Rasmussen, (530) 307-0903, ltwyc2@aol.com
www.tahoewindjammers.com

Saturday, August 15

Steele Cup/Dinghy Weekend, FLYC – Rancho Seco
www.flyc.org

Sunday, August 16

Singlehanded Race, LTWYC – South Lake Tahoe
Kurt Rasmussen, (530) 307-0903, ltwyc2@aol.com
www.tahoewindjammers.com

Saturday, August 22

Singlehanded Regatta, FLYC – Folsom Lake
www.flyc.org

Skipper's Scramble, KBSC – Clear Lake
Brad King, chezking@att.net, info@kbsail.com
www.kbsail.com

Saturday & Sunday, August 29-30

Perpetual Days 1 & 2, LTWYC – South Lake Tahoe
Kurt Rasmussen, (530) 307-0903, ltwyc2@aol.com
www.tahoewindjammers.com

SEPTEMBER

Sunday, September 6

Governor's Cup #1, FLYC – Folsom Lake
www.flyc.org

Saturday, September 12

Summer Series #6, KBSC – Clear Lake
Brad King, chezking@att.net, info@kbsail.com
www.kbsail.com

Sunday, September 13

Late Summer Race, LTWYC – South Lake Tahoe
Kurt Rasmussen, (530) 307-0903, ltwyc2@aol.com
www.tahoewindjammers.com

Governor's Cup #2, FLYC – Folsom Lake
www.flyc.org

Sunday, September 20

Governor's Cup #3, FLYC – Folsom Lake
www.flyc.org

Fannette Island Race, LTWYC – South Lake Tahoe
Kurt Rasmussen, (530) 307-0903, ltwyc2@aol.com
www.tahoewindjammers.com

Saturday, September 26

Singlehanded Race, KBSC – Clear Lake
Brad King, chezking@att.net, info@kbsail.com
www.kbsail.com

Sunday, September 27

Governor's Cup #4, FLYC – Folsom Lake
www.flyc.org

Jack and Jill Race, KBSC – Clear Lake
Brad King, chezking@att.net, info@kbsail.com
www.kbsail.com

OCTOBER

Saturday, October 10

Summer Series #7, KBSC – Clear Lake
Brad King, chezking@att.net, info@kbsail.com
www.kbsail.com

Saturday, October 24

Commodore's Cup, KBSC – Clear Lake
Brad King, chezking@att.net, info@kbsail.com
www.kbsail.com

NOVEMBER

Saturday, November 21

Turkey Race, KBSC – Clear Lake
Brad King, chezking@att.net, info@kbsail.com
www.kbsail.com

DECEMBER

Saturday, December 12

Robinson Midwinter #1, LMSC – Lake Merritt
Mark Marlett, (925) 245-0287

NOVEMBER 2015

● indicates full moon.

S	M	T	W	Th	F	S
1	2	3	4	5	6	7
8	9	10	11	12	13	14
15	16	17	18	19	20	21
22	23	24	25	26	27	28
29	30					

→ indicates 2-day races. YRA events indicated in bold type.

WEEKDAY & SPECIAL EVENTS	SATURDAY	SUNDAY	
<p>November 11: • Veterans Day. Take a veteran sailing!</p> <p>November 17: • YRA Year-End Trophy Party – BYC</p> <p>• The Big Sail (Stanford vs. Cal), StFYC – City</p> <p>November 26: • Thanksgiving Day</p> <p>November 27: • Wild Turkey Race, TYC – NB</p>		<p>Jack & Jill + 1, IYC – Estuary Midwinter #1, SYC – Knox Chowder #5, BYC – OC</p> <p>DAYLIGHT SAVING TIME ENDS 1</p>	
	<p>Opti Winter #1, SFYC – Richardson Bay → Midwinter #1, GGYC – City Winter #1, SeqYC – SB Commodore's Cup, CPYC – SB Fall Series #3, SSC – Stockton Chowder Cup #3, ElkYC – Moss Landing Winter One Design, RegattaPRO – OC Summer's Last Gasp, HMBYC – HMB</p> <p>7</p>	<p>Opti Winter #1, SFYC – Richardson Bay Midwinter #1, IYC – Estuary Chowder #6, BYC – OC</p> <p>8</p>	
	<p>Midwinters #1, BYC – OC Jack Frost Midwinters #1, EYC – Estuary Santana 22 Team Racing, SCYC</p> <p>14</p>	<p>Midwinters #2, BYC – OC</p> <p>15</p>	
	<p>Redwood Cup #1, SeqYC – SB Island Fever #1, SBYC – SB Chowder Cup #4, ElkYC – Moss Landing Midwinter #1, SCYC</p> <p>21</p>	<p>Commodore's Challenge, IYC – Estuary Chowder #7, BYC – OC</p> <p>22</p>	
		<p>Chowder #8, BYC – OC</p> <p>28</p>	<p>29</p>

PERFORMANCE RIGGING

Located
BERKELEY
MARINE CENTER

Wire and Rod Standing Rigging • Running Rigging
Architectural Rigging

Offshore / Inshore
High performance rigging
and deck layouts.

BUTLER RIGGING
butlerrigging@sbcglobal.net
(510) 672-2639 • (510) 665-4744

BSI RIGGING • NEW ENGLAND ROPES • SCHAEFER



BERKELEY MIDWINTERS

Where the heat is on all winter long!

The longest running winter series on the Bay.

New set-marks to avoid shallow water!

Separate Saturday and Sunday series!

Second weekend of the month from November through February!



Enter them both and use the BYC guest dock overnight.

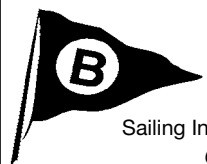

Check out www.berkeleyyc.org for Notice of Race, Entry Form, Sailing Instructions, results and much, much more.
Call or email for more information

Bob Gray
(510) 530-4162
r_gray40@sbcglobal.net

Bobbi Tosse
(925) 939-9885
bobbi@jfcbat.com

COLLEGE SAILING

Many colleges and universities around the country field competitive sailing teams. Some Northern California schools with sailing teams include: **Cal Berkeley**; **Cal Maritime Academy**, Vallejo; **Cal Poly University**, San Luis Obispo; **Cal State University Monterey Bay**, Seaside; **Santa Clara University**; **Stanford**, Palo Alto; **UC Davis**; **UC Santa Cruz**.

PACIFIC COAST COLLEGIATE SAILING CONFERENCE EVENTS

1/3-4	Rose Bowl Interconference Regatta	USC	CFJ
1/17-18	Peter Wenner Memorial Rainbow Invitational	Hawaii	CFJ
1/24-25	Jeff Simon Memorial Regatta	UCSD/MBYC	CFJ
2/7-8	Mustang Open	SLO/MBYC	
2/7-8	Harris Kempner Memorial	Texas A&M, Galveston	420
2/14-15	Anteater Open	UC Irvine	
2/21-22	Charleston Spring	College of Charleston	420/FJ
2/21-22	Women's Interconference	University of South Florida	FJ
2/21-22	Nelson Roltsch	Southern YC, NOLA	420
2/21-22	Old South	University of Florida	420
2/28-3/1	Frank Mendelblatt Team Race	USF	FJ
2/28-3/1	Jeremy McIntyre Team Race	Stanford	FJ/Z420
2/28-3/1	Women's Interconference	Charleston	420/FJ
3/7-8	Beach Gold/Silver	CSULB	
3/7-8	Bob Bavier Team Race	Charleston	420/FJ
3/13-15	Harbor Cup	LAYC	Catalina 37
3/14-15	Sea Otter Open	CSUMB	BYO CFJ
3/14-15	Eckerd Interconference	Eckerd College, FL	FJ
3/14-15	Navy Women's Spring	Navy	Z420/FJ
3/14-15	St. Mary's Team Race	St. Mary's	FJ/Z420
3/14-15	John Jackson Team Race	Georgetown	FJ
3/21-22	St. Mary's Women's Interconference	St. Mary's	FJ/Z420
3/21-22	Graham Hall Team Race	Navy	FJ/Z420
3/21-22	Southern New England Team Race	Connecticut College	FJ
3/28-29	South Designate	USC	BYO CFJ
3/28-29	Aaron Szambecki Team Race	Old Dominion	FJ
3/28-29	Admiral Moore Team Race	NY Maritime	420/FJ
3/28-29	Friis Team Race	Harvard	FJ
3/28-29	Duplin Women's Team Race	Tufts	Larks
4/4-5	St. Francis Invitational	St. Francis YC	BYO CFJ
4/4-5	Lynne Marchiando Team Race	MIT	FJ/Fireflies
4/4-5	Dellenbaugh Women's Trophy	Brown U, RI	Z420
4/11-12	Emily Wick Trophy	Coast Guard Academy, CT	FJ/420
4/11-12	Bryson Women's	Stanford	
4/11-12	Cardinal Invite Gold/Silver	Stanford	
4/18-19	Carley Dole Memorial Women's Conference Championships	UCSB	
4/18-19	President's Trophy Women's	Boston U	
4/18-19	Navy Spring	Navy	Z420/FJ
4/18-19	Thompson Trophy	Coast Guard	FJ/420
4/18-19	Rainier Cup	OSU, The Gorge, Cascade Locks, OR	CFJ
4/25-26	Boston Dinghy Club Challenge Cup	Harvard/MIT, MA	FJ/Firefly
4/25-26	George E. Morris Trophy	Boston U	FJ
4/25-26	Admiral's Cup	Kings Point, NY	420/FJ/Laser
5/1-2	Mark Healy Coed Conference Championship	Stanford	
5/3	Carter Ford Team Race Conference Championship	Stanford	
5/25-26	Women's Eastern Semifinals	TBD	
5/25-25	Women's Western Semifinals	TBD	
5/27-28	Women's Finals	TBD	
5/29-31	Team Race Nationals	TBD	
6/1-2	Coed Eastern Semifinals	TBD	
6/1-2	Coed Western Semifinals	TBD	
6/3-4	Coed Finals	TBD	

See www.pccscracing.org for more information, including the Fall Season.



Serving the Bay Area Since 1986

Seashine

THE FASTEST POLISH ON THE BAY!

Be Race Ready Friday With Our Mid-Week Clean & Prep

Fully Insured & Marina Approved
Call now for a Free Estimate

510 428-2522 or 415 457-6300
www.seashine.net

DECEMBER 2015

● indicates full moon.

→ indicates 2-day races. **YRA events indicated in bold type.**

S	M	T	W	Th	F	S
		1	2	3	4	5
6	7	8	9	10	11	12
13	14	15	16	17	18	19
20	21	22	23	24	25	26
27	28	29	30	31		

WEEKDAY & SPECIAL EVENTS	SATURDAY	SUNDAY
<p>December:</p> <ul style="list-style-type: none"> Happy Holidays! Check the Calendar in the Nov. or Dec. issue of <i>Latitude 38</i> for lighted boat parades, like the one below. <p>December 5:</p> <ul style="list-style-type: none"> Lighted Boat Parade, SCYC <p>December 6:</p> <ul style="list-style-type: none"> Hanukkah begins at sundown <p>December 22:</p> <ul style="list-style-type: none"> Winter Solstice <p>December 25:</p> <ul style="list-style-type: none"> Christmas Day <p>December 31:</p> <ul style="list-style-type: none"> New Year's Eve 	<p>Midwinter #2, GGYC – City Winter #2, SeqYC – SB Fall Series #4, SSC – Stockton Opti Midwinters #1, RYC – Keller Cove</p> <p style="text-align: right;">5</p>	<p>Chowder #9, BYC – OC Midwinter #2, SYC – Knox Small Boat Midwinters #1, RYC – SH</p> <p style="text-align: right;">6</p>
	<p>Midwinters #3, BYC – OC Redwood Cup #2, SeqYC – SB Chowder Cup #5, ElkYC – Moss Landing Winter One Design, RegattaPRO – OC Santana 22 Team Racing, SCYC</p> <p style="text-align: right;">12</p>	<p>Midwinters #4, BYC – OC Midwinter #2, IYC – Estuary</p> <p style="text-align: right;">13</p>
	<p>Island Fever #2, SBYC – SB Midwinter #2, SCYC</p> <p style="text-align: right;">19</p>	<p>Chowder #10, BYC – OC</p> <p style="text-align: right;">20</p>
	<p style="text-align: right;">26</p>	<p>Chowder #11, BYC – OC</p> <p style="text-align: right;">27</p>

SHIRLEY VAUGHAN

deWitt

Art for
Winners!



Check out Jim's online stores at:

www.jimdewitt.com ☎ www.DeWittAmericasCupArt.com

DeWitt Art Gallery & Framing ☎ (510) 236-1401 ☎ pam@jimdewitt.com

SAN FRANCISCO BAY

These current charts show direction and speed of the tidal current for each hour of current at the San Francisco Bay entrance. The charts depict the flow of tidal currents under normal weather conditions. Strong winds and freshets, however, bring about non-tidal currents which may modify considerably the speeds and directions shown in the charts.

USE OF CHARTS

The chart to be used for any specific time is determined by obtaining the difference between the desired time and the time of the nearest Maximum Flood or Maximum Ebb for the Golden Gate. The chart with the title that agrees most nearly with this difference is the one to be used.

The numbers before or after the arrows indicate the 'tropic speed' of the current in knots. To determine the actual speed of the current for a particular day and hour, this tropic speed is multiplied by the factor given in the table to the right, 'Factors for Correcting Speeds'. To find the correct 'predicted speed' as listed in the table, see 'Weekend Currents' on pages 86 and 88.

The charts on this page and those that follow are from the National Ocean Service, National Oceanic and Atmospheric Administration of the U.S. Department of Commerce.

FACTORS FOR CORRECTING SPEEDS

MAXIMUM FLOOD			MAXIMUM EBB		
Predicted speed (knots)	Factor		Predicted Speed (knots)	Factor	
0.5-0.8,	multiply by	0.2	0.7-1.1,	multiply by	0.2
0.9-1.1,	multiply by	0.3	1.2-1.5,	multiply by	0.3
1.2-1.4,	multiply by	0.4	1.6-2.0,	multiply by	0.4
1.5-1.8,	multiply by	0.5	2.1-2.4,	multiply by	0.5
1.9-2.1,	multiply by	0.6	2.5-2.9,	multiply by	0.6
2.2-2.4,	multiply by	0.7	3.0-3.3,	multiply by	0.7
2.5-2.8,	multiply by	0.8	3.4-3.8,	multiply by	0.8
2.9-3.1,	multiply by	0.9	3.9-4.2,	multiply by	0.9
3.2-3.4,	multiply by	1.0	4.3-4.7,	multiply by	1.0
3.5-3.7,	multiply by	1.1	4.8-5.1,	multiply by	1.1
3.8-4.1,	multiply by	1.2	5.2-5.6,	multiply by	1.2
4.2-4.4,	multiply by	1.3	5.7-6.0,	multiply by	1.3
4.5-4.7,	multiply by	1.4	6.1-6.5,	multiply by	1.4
4.8-5.1,	multiply by	1.5	6.6-6.9,	multiply by	1.5

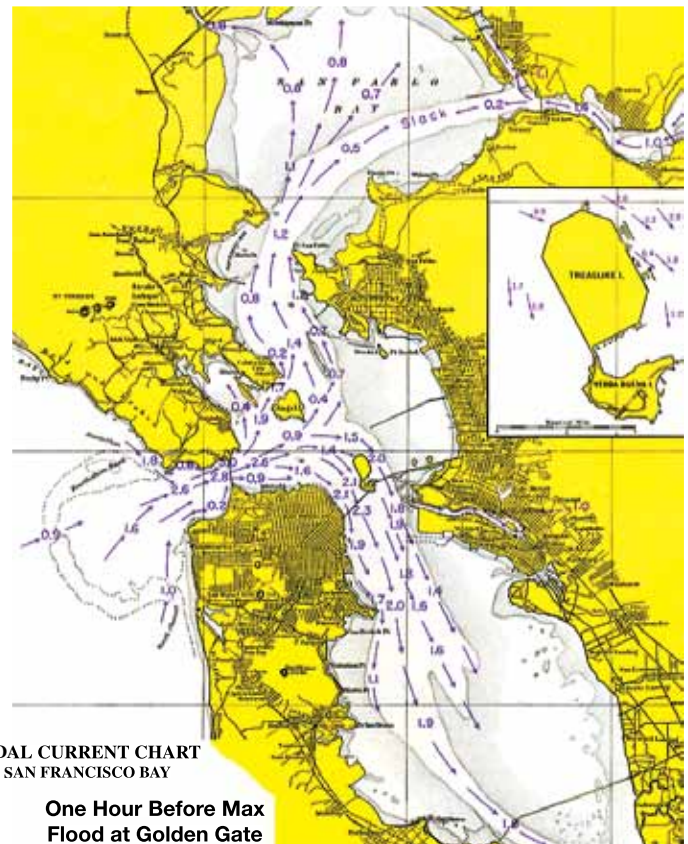
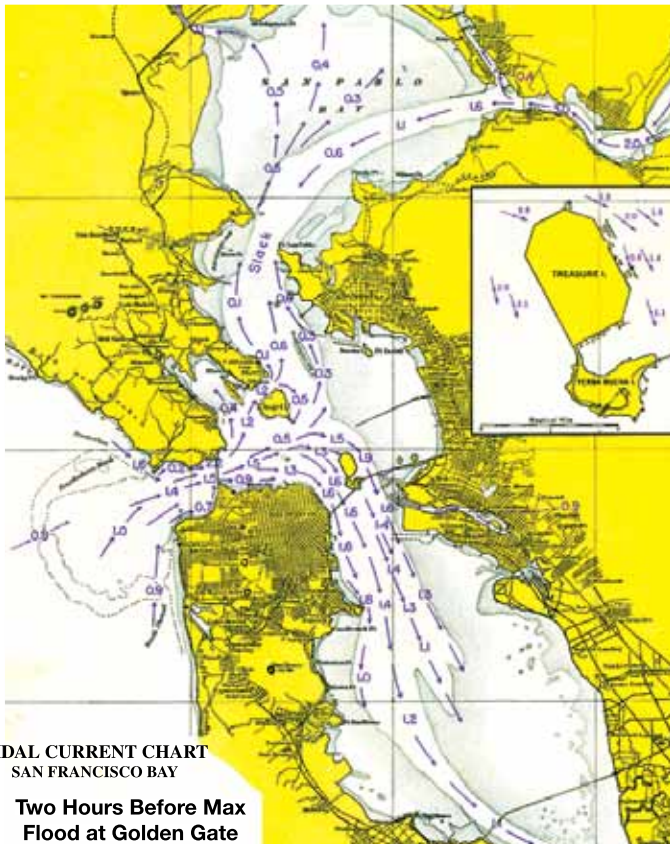

TIDAL CURRENT CHARTS

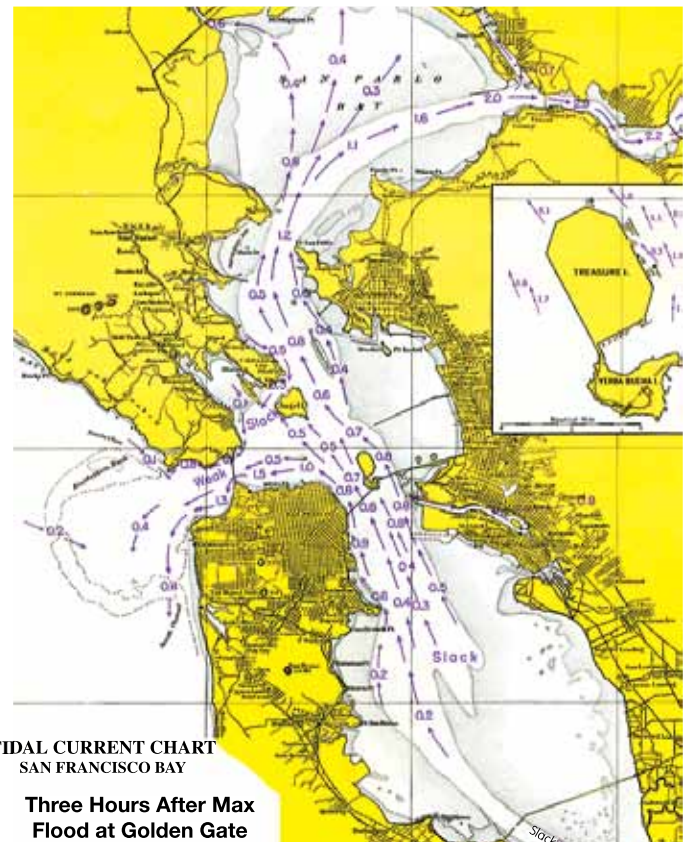
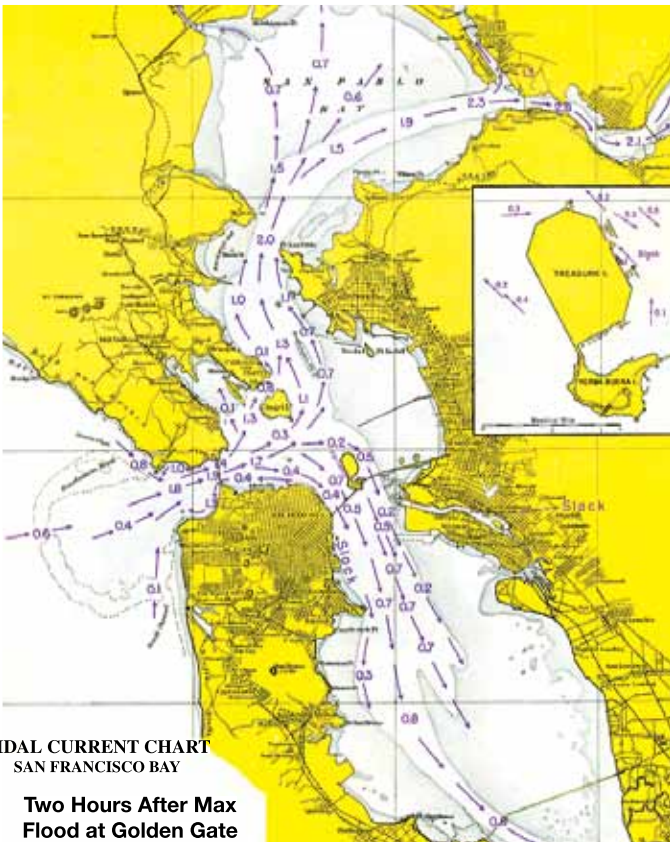
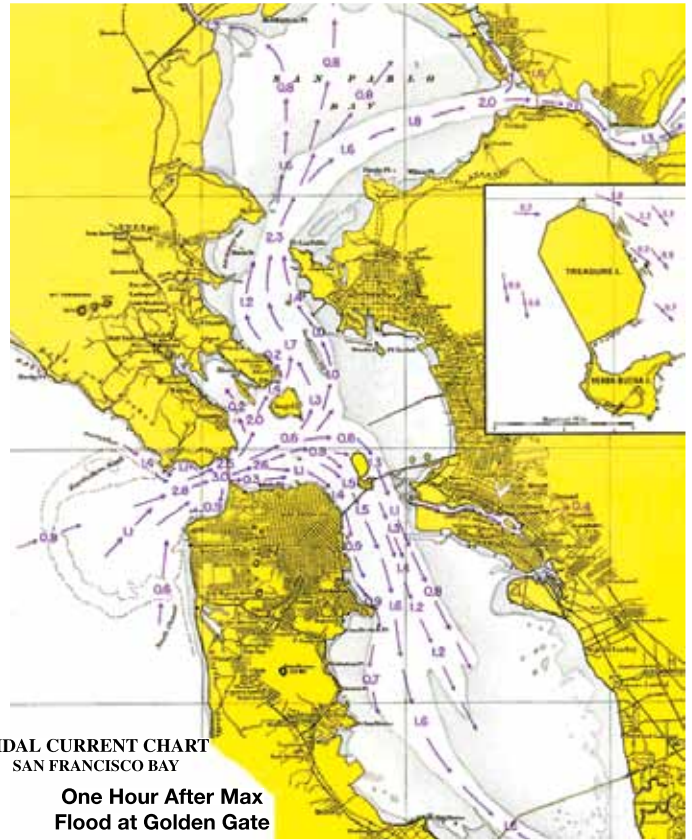
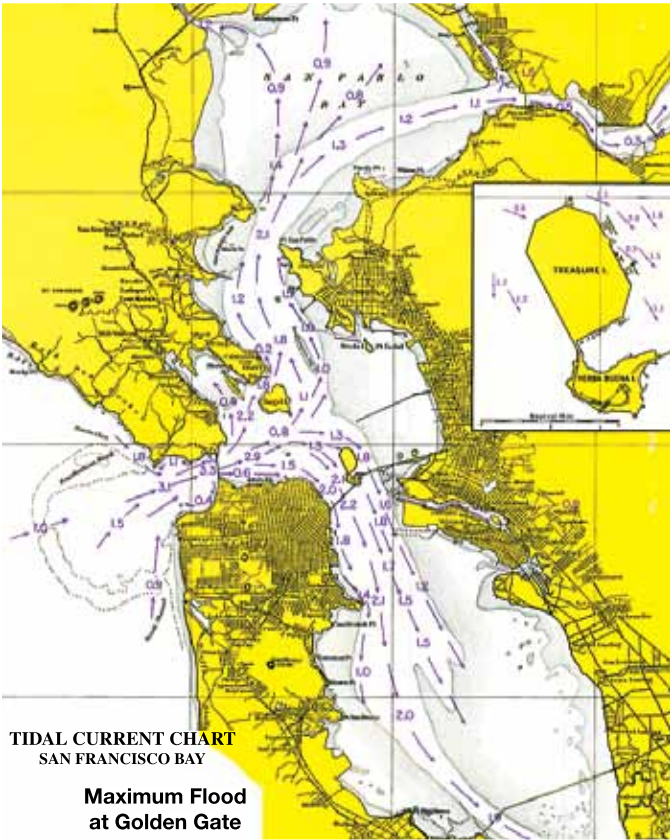

SAN FRANCISCO BAY

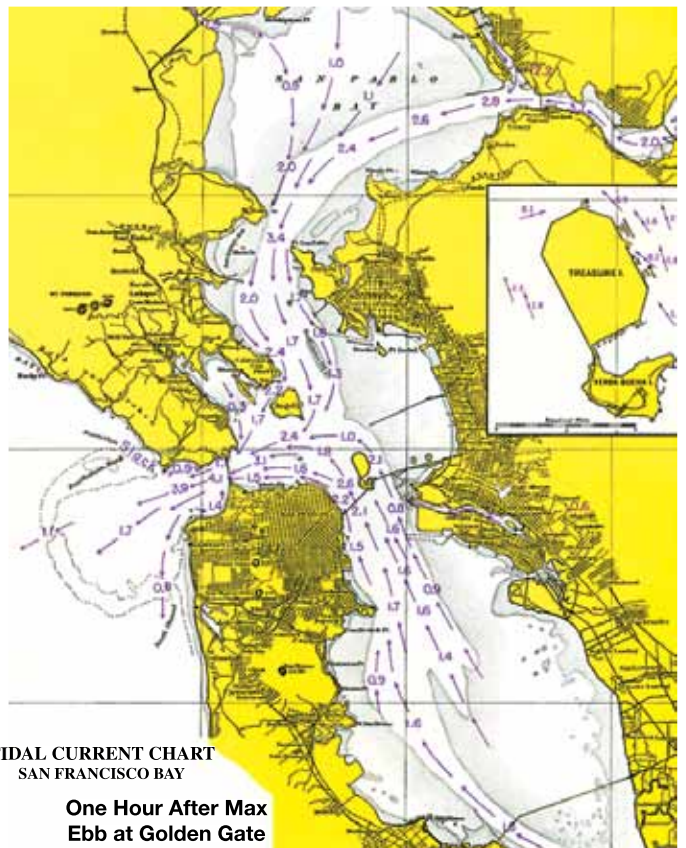
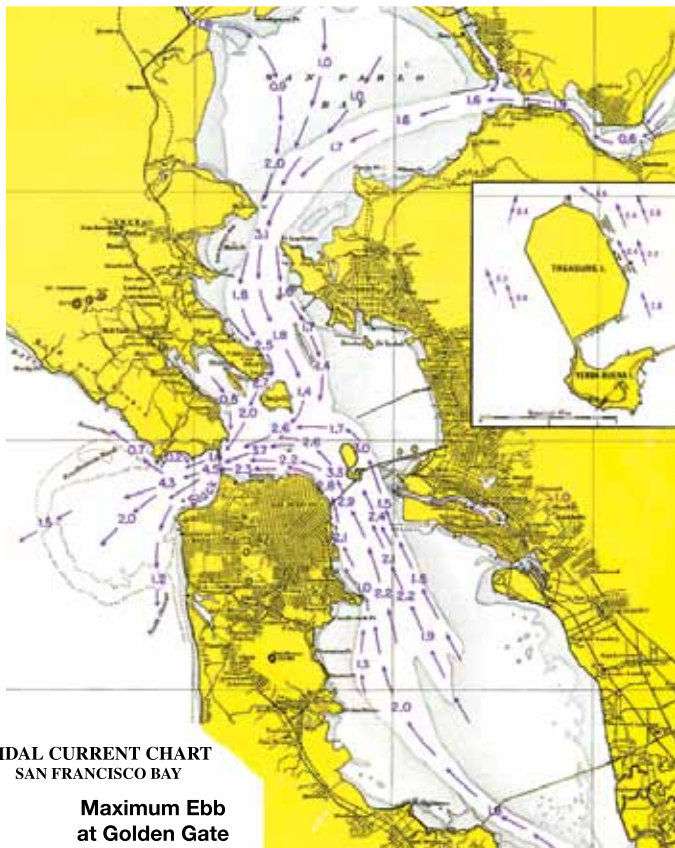
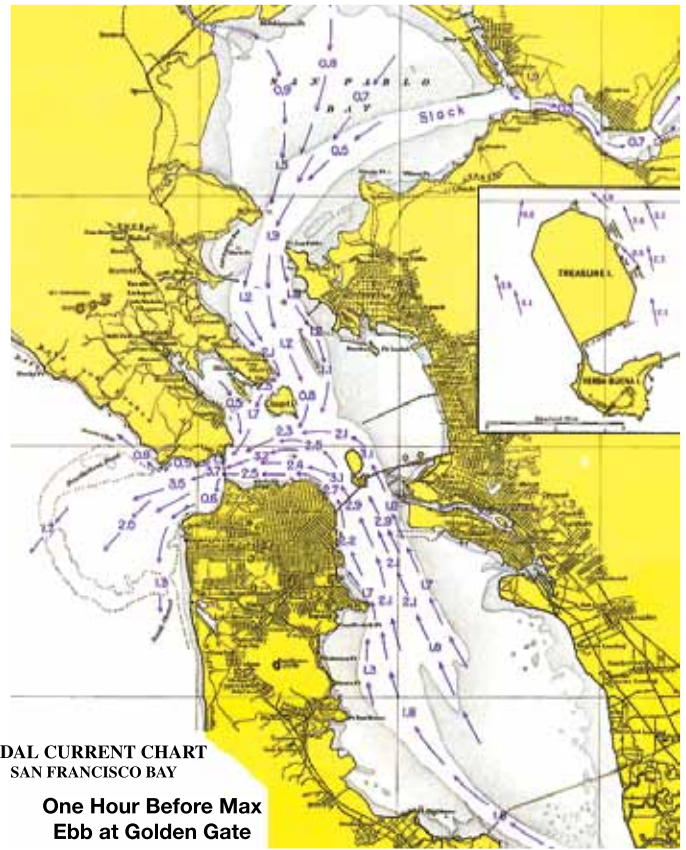
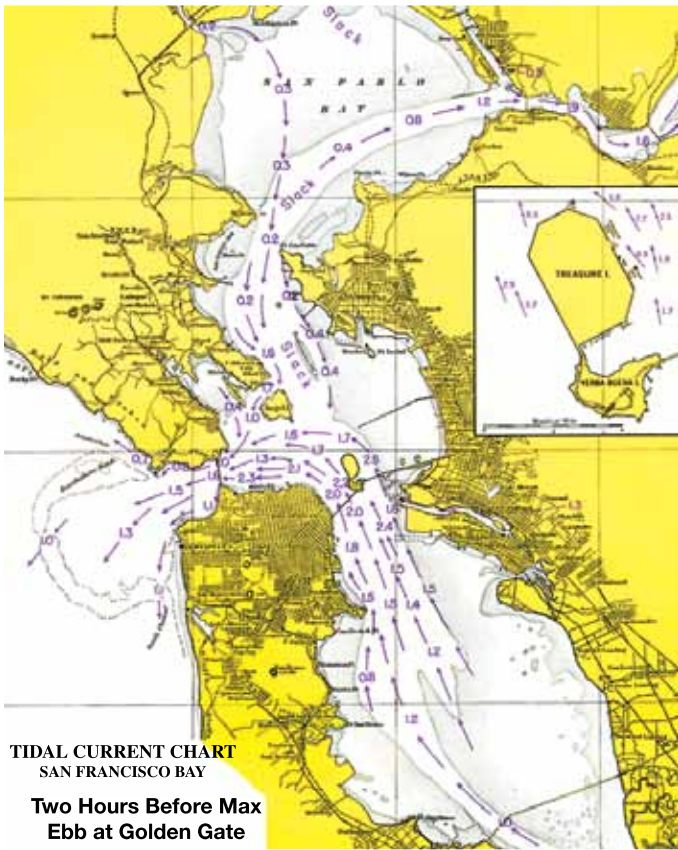

TIDAL CURRENT CHARTS

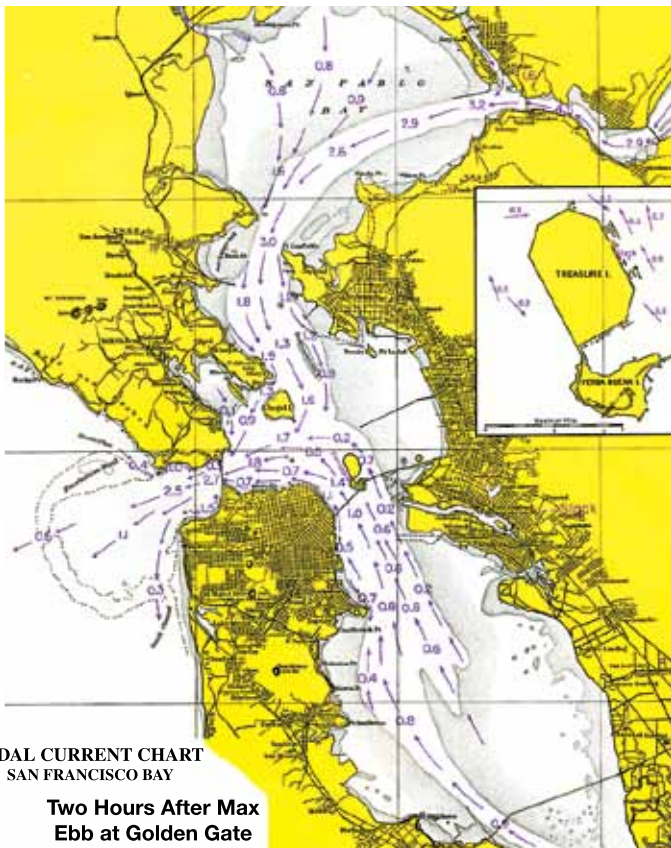

TIDAL CURRENT CHART
SAN FRANCISCO BAY

Two Hours After Max
Ebb at Golden Gate

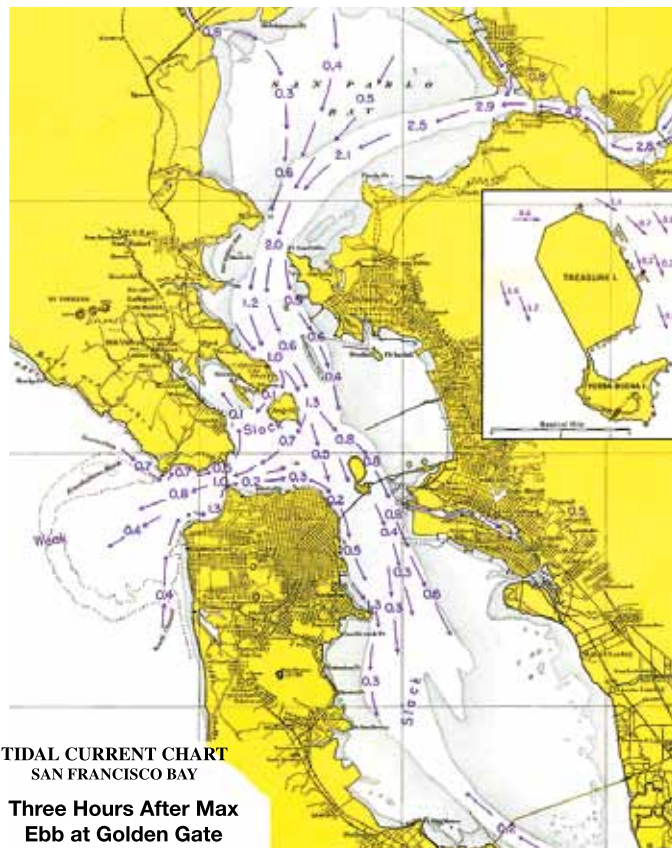

TIDAL CURRENT CHART
SAN FRANCISCO BAY

Three Hours After Max
Ebb at Golden Gate



SailSF Bay.org

SailSF Bay.org

Gateway to Sailing

Visit our new website. Become a member.
Supported by businesses, yacht clubs, fleets, organizations and individuals.



Dedicated to Growing Participation in Bay Area Sailing

2015 WEEKEND CURRENTS

JANUARY – JUNE

J A N U A R Y	date/day	slack	max	slack	max	F E B R U A R Y	date/day	slack	max	slack	max	M A R C H	date/day	slack	max	slack	max
	1/03Sat			0226/2.5E	0534		0805/2.5F	2/01Sun			0212/2.5E		0527	0748/2.3F	3/01Sun		
	1039		1424/4.1E	1851	2130/3.1F		1026		1416/3.8E	1833	2112/3.0F		0921		1319/3.3E	1726	2009/2.7F
1/04Sun	0033		0318/2.6E	0626	0854/2.5F		2/07Sat		0003/2.6F	0257	0608/2.6E		3/07Sat	0133	0451/3.0E	0847	1116/2.2F
	1124		1510/4.0E	1935	2213/3.1F			1001	1224/1.7F	1439	1809/3.0E			1347	1704/3.1E	2034	2321/2.5F
1/10Sat			0123/2.3F	0424	0738/2.3E		2/08Sun		0038/2.4F	0316	0636/2.6E		3/08Sun	0153	0616/3.0E	1026	1300/2.0F
	1134		1340/1.2F	1535	1923/2.6E			2145						1529	1843/2.8E	2203	
1/11Sun			0201/2.1F	0448	0815/2.2E		2/14Sat	0248	0531/1.5F	0731	1138/3.1E		3/14Sat	0222	0458/1.3F	0649	1055/2.8E
	1241		1434/1.0F	1623	2014/2.2E			1639	1910/2.2F	2217				1610	1844/1.8F	2154	
1/17Sat			0110/2.0E	0403	0651/1.9F		2/15Sun		0050/2.0E	0349	0629/1.8F		3/15Sun		0035/1.8E	0335	0607/1.4F
	0859		1252/3.6E	1746	2021/2.6F			0836	1234/3.5E	1719	1955/2.6F			0804	1213/3.0E	1701	1938/2.3F
1/18Sun			0157/2.1E	0454	0741/2.2F		2/16Mon		0136/2.3E	0443	0723/2.2F		3/21Sat	0146	0500/4.1E	0853	1139/3.2F
	0950		1337/4.0E	1823	2105/2.9F			0937	1324/3.9E	1757	2037/3.0F			1424	1733/3.6E	2102	2351/3.4F
1/24Sat			0036/3.3F	0324	0626/3.3E		2/21Sat	0204	0511/3.8E	0856	1143/2.9F		3/22Sun	0223	0542/4.2E	0946	1231/3.1F
	1007		1251/2.4F	1512	1840/3.6E			1417	1735/3.7E	2111				1522	1823/3.3E	2145	
1/25Sun			0121/3.1F	0402	0715/3.4E		2/22Sun		0004/3.3F	0241	0554/3.8E		3/28Sat	0306	0508/1.3F	0728	1150/2.6E
	1113		1351/2.1F	1615	1939/3.0E			0953	1238/2.7F	1516	1827/3.3E			1616	1903/2.0F	2153	
1/31Sat			0120/2.4E	0432	0656/2.2F		2/28Sat		0010/2.1E	0325	0538/1.7F		3/29Sun		0052/2.2E	0419	0618/1.3F
	0934		1330/3.7E	1750	2031/2.8F			0815	1228/3.1E	1641	1927/2.4F			0854	1305/2.7E	1709	1955/2.2F
	2326							2215						2245			
A P R I L	date/day	slack	max	slack	max	M A Y	date/day	slack	max	slack	max	J U N E	date/day	slack	max	slack	max
	4/04Sat	0113	0438/3.3E	0843	1113/2.4F		5/02Sat			0327/3.4E	0746		1011/2.3F	6/06Sat			0058/2.0F
	1355		1700/2.9E	2021	2307/2.5F			1302	1552/2.6E	1908	2152/2.4F			1106	1412/2.9F	1715	2001/2.3E
4/05Sun	0133		0503/3.4E	0919	1155/2.4F		5/03Sun	0017	0351/3.5E	0820	1053/2.5F		6/07Sun		0153/1.8F	0351	0737/3.8E
	1438		1739/2.8E	2052	2341/2.4F			1345	1634/2.5E	1940	2229/2.4F			1153	1500/2.8F	1758	2053/2.4E
4/11Sat			0328/1.3F	0517	0913/3.0E		5/09Sat		0209/1.6F	0403	0750/3.5E		6/13Sat		0136/4.1E	0602	0832/2.7F
	1413		1702/1.9F	2016	2259/1.7E			1225	1532/2.3F	1837	2124/2.0E			1134	1418/2.6E	1726	2012/2.8F
4/12Sun			0435/1.2F	0622	1028/2.9E		5/10Sun	0032	0309/1.4F	0458	0854/3.2E		6/14Sun		0222/4.3E	0652	0927/3.0F
	1520		1803/2.1F	2115				1326	1626/2.3F	1933	2225/2.1E			1231	1512/2.6E	1819	2101/2.9F
4/18Sat	0031		0350/4.3E	0755	1037/3.3F		5/16Sat		0242/4.3E	0659	0935/3.1F			2332			
	1331		1630/3.3E	1951	2238/3.3F			1235	1524/3.0E	1839	2125/3.1F		6/20Sat		0106/1.9F	0319	0703/3.5E
4/19Sun	0108		0433/4.5E	0845	1128/3.3F		5/17Sun	1330	1617/2.9E	1926	2212/3.1F			1124	1406/2.7F	1722	2020/2.4E
	1427		1721/3.2E	2035	2322/3.1F			1248	1528/2.3F	1846	2146/2.2E		6/21Sun		0157/1.6F	0404	0751/3.1E
4/25Sat			0340/1.3F	0540	0944/2.6E		5/23Sat	0007	0220/1.6F	0422	0814/3.1E			1204	1448/2.4F	1803	2110/2.3E
	1432		1703/1.9F	2021	2321/2.1E			0119	0316/1.2F	0513	0914/2.7E		6/27Sat		0109/2.8E	0552	0803/1.5F
4/26Sun	0256		0444/1.1F	0654	1107/2.4E		5/24Sun	1341	1617/2.1F	1939	2246/2.1E			1055	1332/1.9E	1628	1916/1.8F
	1531		1808/1.9F	2117				0235	0416/1.0F	0616	1019/2.4E		6/28Sun		0137/3.1E	0628	0848/1.9F
							5/25Mon	1433	1706/1.9F	2028	2348/2.2E			1147	1418/2.0E	1714	2001/1.9F
							5/30Sat		0221/3.2E	0651	0909/2.0F			2215			
								1203	1443/2.3E	1752	2036/2.2F						
							5/31Sun		0244/3.5E	0725	0951/2.3F						
								2302	1526/2.3E	1828	2116/2.2F						
								1249									
								2331									

continued on page 88

Quick
Turnaround
for Racers!



Specializing
in Sail Repair
and Service.

Marchal Sailmakers

2021 ALASKA PACKER PLACE, ALAMEDA, CA 94501
 Dominic Marchal • (510) 239-5050
www.marchalsailmakers.com



Express 27

THE ULTIMATE SAILING MACHINE

www.express27.org

Fleet Captain:
Zachery Anderson
zachery.anderson@gmail.com

2015 SUNRISE AND SUNSET

As observed from sea level at the Golden Gate Bridge

Pacific Standard Time
Corrected for Daylight Saving Time

	RISE	SET		RISE	SET
JANUARY					
1.....	7:15	16:51	JULY	1.....	5:41 20:26
5.....	7:16	16:55		5.....	5:43 20:26
10.....	7:16	17:00		10.....	5:46 20:24
15.....	7:15	17:05		15.....	5:49 20:22
20.....	7:13	17:10		20.....	5:53 20:19
25.....	7:10	17:15		25.....	5:57 20:16
30.....	7:06	17:20		30.....	6:01 20:11
FEBRUARY					
1.....	7:05	17:23	AUGUST	1.....	6:03 20:09
5.....	7:01	17:27		5.....	6:06 20:05
10.....	6:56	17:33		10.....	6:10 20:00
15.....	6:51	17:38		15.....	6:15 19:54
20.....	6:45	17:44		20.....	6:19 19:47
25.....	6:38	17:49		25.....	6:23 19:41
				30.....	6:28 19:33
MARCH					
1.....	6:33	17:53	SEPTEMBER	1.....	6:29 19:30
5.....	6:27	17:57		5.....	6:33 19:25
10.....	7:20	19:02		10.....	6:37 19:17
15.....	7:12	19:06		15.....	6:41 19:09
20.....	6:05	19:11		20.....	6:45 19:01
25.....	6:57	19:16		25.....	6:50 18:54
30.....	6:50	19:20		30.....	6:54 18:46
APRIL					
1.....	6:47	19:22	OCTOBER	1.....	6:55 18:44
5.....	6:41	19:26		5.....	6:58 18:38
10.....	6:33	19:30		10.....	7:03 18:31
15.....	6:26	19:35		15.....	7:08 18:24
20.....	6:19	19:40		20.....	7:12 18:17
25.....	6:13	19:44		25.....	7:17 18:10
30.....	6:06	19:49		30.....	7:22 18:04
MAY					
1.....	6:05	19:50	NOVEMBER	1.....	6:25 17:02
5.....	6:01	19:53		5.....	6:29 16:58
10.....	5:55	19:58		10.....	6:34 16:53
15.....	5:51	20:02		15.....	6:39 16:49
20.....	5:47	20:07		20.....	6:45 16:46
25.....	5:43	20:11		25.....	6:50 16:43
30.....	5:41	20:14		30.....	6:55 16:42
JUNE					
1.....	5:40	20:16	DECEMBER	1.....	7:06 16:51
5.....	5:39	20:18		5.....	7:10 16:50
10.....	5:38	20:21		10.....	7:14 16:50
15.....	5:37	20:23		15.....	7:17 16:51
20.....	5:38	20:25		20.....	7:21 16:53
25.....	5:39	20:26		25.....	7:23 16:56
30.....	5:41	20:26		30.....	7:24 16:59

This table may be used in the vicinity of the stated location with less than a 2-minute error.

Latitude 38

2015 Sailing Calendar and YRA Master Schedule

Publisher/Exec. Editor.....	Richard Spindler.....	richard@latitude38.com	ext. 111
Associate Publisher.....	John Arndt.....	john@latitude38.com	ext. 108
Managing Editor.....	Andy Turpin.....	andy@latitude38.com	ext. 112
Racing Editor.....	Christine Weaver.....	chris@latitude38.com	ext. 103
Advertising Sales.....	John Arndt.....	john@latitude38.com	ext. 108
Advertising Sales.....	Mike Zwiebach.....	mikez@latitude38.com	ext. 107
General Manager.....	Colleen Young.....	colleen@latitude38.com	ext. 102
Production.....	Annie Bates-Winship.....	annie@latitude38.com	ext. 106
Production.....	Carrie Galbraith.....	carrie@latitude38.com	ext. 110
Bookkeeping.....	Penny Clayton.....	penny@latitude38.com	ext. 101
Other email.....	general@latitude38.com.....	Web site: www.latitude38.com	

Latitude 38 Publishing, LLC
15 Locust Avenue, Mill Valley, CA 94941
(415) 383-8200 • Fax: (415) 383-5816
www.latitude38.com

Please address all correspondence by person or department name.

San Francisco to Monterey

The San Francisco Yacht Club and
Monterey Peninsula Yacht Club

invite you to spend
your Memorial Day
Weekend racing in
the 18th Annual
Spinnaker Cup



Start on Friday, May 22, in the Knox Race Area.
Finish off Municipal Wharf #2 in Monterey.

The Notice of Race
will be available at: www.sfyc.org and www.mpyc.org

For further information please contact:
Race Office, SFYC 415.789.5647 race@sfyc.org
Rear Commodore, MPYC 831.372.9686 race@mpyc.org

WATERAT

SAILING EQUIPMENT

- One design & offshore rudders & shafts
- Dinghy centerboards & rudders
- Custom structural composites

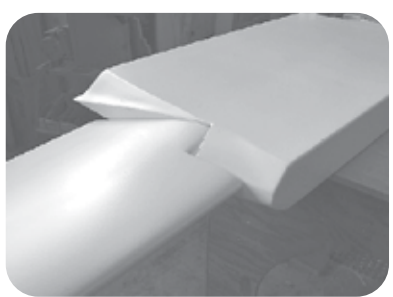

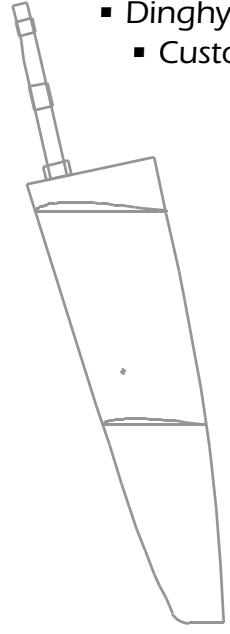



831-768-1520
e-mail: larry@waterat.com
565 McQuaide Dr. La Selva Beach, CA 95076

JULY – DECEMBER

NOAA Predictions at the Golden Gate Entrance

from page 86

	JULY					AUGUST					SEPTEMBER					OCTOBER					NOVEMBER					DECEMBER				
	date/day	slack	max	slack		max	date/day	slack	max		slack	max	date/day	slack		max	slack	max	date/day		slack	max	slack	max		date/day	slack	max	slack	max
	7/03Fri	0110	0455/4.3E	0922	1216/3.2F	8/01Sat	0103	0444/4.3E	0856	1147/3.4F	9/05Sat	0146	0414/2.0F	0719	1008/2.0E	10/03Sat	0010	0254/2.4F	0558	0848 2.3E	11/1Sun		0136/2.6F	0448	0738/2.3E	12/05Sat	0241	0516/1.9F	0823	1209/2.7E
	1522	1802/2.5E	2106	2354/2.3F		1444	1734/3.0E	2051	2340/2.7F		1314	1557/2.0F	1811	2159/3.1E		1154	1436/2.1F	1646	2027/3.4E		1047	1317/1.9F	1524	1908/3.3E		1617	1821/1.3F	2102		
	7/04Sat	0159	0543/4.3E	1001	1258/3.2F	8/02Sun	0155	0532/4.3E	0934	1228/3.4F	9/06Sun	0305	0529/1.9F	0839	1126/1.9E	10/04Sun	0121	0355/2.2F	0707	0956/2.1E	11/7Sat		0040/2.6E	0420	0652/2.2F	12/06Sun		0003/2.1E	0324	0600/1.9F
	1600	1845/2.7E	2158			1519	1815/3.2E	2142			1434	1700/1.7F	1921	2325/3.0E		1308	1535/1.7F	1742	2135/3.0E		0953	1321/3.1E	1719	1933/1.9F		0855	1246/3.0E	1702	1916/1.7F	
	7/05Sun		0044/2.3F	0251	0633/4.2E	8/08Sat	0329	0549/1.8F	0854	1140/2.0E	9/07Mon	0415	0652/2.0F	0950	1241/2.1E	10/10Sat		0254/3.1E	0641	0912/2.6F	11/8Sun		0121/2.6E	0455	0726/2.3F	12/12Sat	0150	0427/2.2E	0722	1007/2.1F
	1041	1342/3.2F	1637	1930/2.8E		1441	1724/2.0F	1952	2348/3.3E		1554	1809/1.7F	2043			1211	1528/3.2E	1915	2135/2.4F		1020	1353/3.3E	1759	2018/2.2F		1207	1553/4.0E	2030	2323/2.8F	
	2252					8/09Sun	0438	0710/2.1F	1009	1254/2.1E	9/12Sat	0035	0401/3.5E	0754	1027/2.9F	10/11Sun	0023	0332/3.1E	0712	0944/2.6F	11/14Sat	0252	0532/2.2E	0829	1112/1.9F	12/13Sun	0232	0509/2.2E	0808	1051/2.0F
	7/11Sat	1021	1307/2.2E	1607	1853/2.4F	8/15Sat	0129	0504/3.8E	0904	1138/3.0F	9/13Sun	0118	0439/3.4E	0825	1059/2.8F		1236	1600/3.3E	1955	2219/2.5F		1311	1655/3.8E	2131			1250	1637/4.0E	2106	
	2127					1443	1748/2.9E	2117	2339/2.4F	9/19Sat	0028	0313/1.5F	0554	0855/1.8E	10/17Sat	1037	1320/1.7F	1520	1859/3.4E	11/15Sun	0916	1157/1.8F	1353	1737/3.7E	12/19Sat	0100	0401/2.5F	0643	1008/3.1E	
	7/12Sun	1126	1406/2.4E	1710	1949/2.5F	8/16Sun	0211	0542/3.6E	0936	1212/2.8F	9/20Sun	0132	0409/1.4F	0707	0956/1.5E		1258	1626/3.4E	2034	2301/2.5F		1020	1353/3.3E	1759	2018/2.2F		1207	1553/4.0E	2030	2323/2.8F
	2223					1514	1822/2.9E	2202		9/26Sat		0238/3.7E	0637	0921/3.2F	10/18Sun	1127	1408/1.5F	1602	1946/3.2E	11/21Sat	0243	0536/2.6F	0824	1146/3.3E	12/20Sun	0158	0456/2.5F	0733	1108/3.5E	
	7/18Sat	0222	0603/3.7E	1013	1250/2.9F	8/22Sat	0241	0443/1.0F	0730	1024/1.5E	9/27Sun	0008	0327/3.8E	0715	1002/3.3F		1037	1320/1.7F	1520	1859/3.4E		1551	1814/2.0F	2056			1250	1637/4.0E	2106	
	1603	1901/2.7E	2227			1316	1605/1.4F	1803	2201/2.5E	9/29Sat	0008	0341/4.1E	0749	1035/3.3F	10/24Sat	1053	1402/3.5E	1755	2027/2.5F	11/22Sun	0906	1232/3.8E	1645	1915/2.5F	12/25Fri	0051	0334/2.7E	0637	0916/2.8F	
	7/19Sun	1047	1327/2.7F	1637	1941/2.6E	8/23Sun	0345	0552/1.1F	0857	1134/1.4E	9/30Sun	0102	0431/4.1E	0826	1115/3.5F		2309			11/26Th	0101	0345/2.7E	0648	0934/2.9F	12/26Sat	0140	0426/2.7E	0732	1006/2.7F	
	2319					1423	1703/1.2F	1857	2306/2.5E	9/30Sun	1400	1703/3.6E	2038	2327/3.0F	10/25Sun	1127	1441/4.0E	1843	2121/2.9F	11/27Fri	0155	0438/2.7E	0741	1022/2.8F	12/27Sun	0228	0516/2.7E	0828	1056/2.5F	
	7/25Sat	0434	0633/1.0F	0925	1206/1.5E	8/29Sat	0008	0341/4.1E	0749	1035/3.3F	9/30Sun	1244	1551/3.8E	1938	2224/3.1F		2309			11/28Sat	0247	0531/2.6E	0837	1112/2.5F	12/31Th		0207/2.4F	0516	0834/2.4E	
	1454	1743/1.4F	1951			1327	1622/3.2E	1949	2237/2.9F	9/30Sun	0936	1203/2.2F	1417	1758/3.8E	10/31Sat	1044	1321/2.3F	1534	1911/3.8E	11/29Sun	0936	1203/2.2F	1417	1758/3.8E		1233	1428/1.2F	1635	2018/2.5E	
	7/26Sun	1032	1306/1.6E	1553	1839/1.5F	8/30Sun	0102	0431/4.1E	0826	1115/3.5F		2352				2352				11/29Sun	0936	1203/2.2F	1417	1758/3.8E						

**Remember to Thank
Your Crew This Season...**

Show your appreciation with

Latitude 38
Logowear

Visit: www.latitude38.com

Latitude 38 Logowear • 15 Locust Ave., Mill Valley, CA 94941



MARINA BAY YACHT HARBOR



***SAIL FAST
HAVE FUN***

Come Home to Marina Bay

**DEEP DRAFT
RACING BERTHS**

★ ★ ★ ★

**CLOSE TO
BOATYARDS,
CHANDLERIES,
RIGGERS AND
SAIL LOFTS**

**CONVENIENT
ACCESS
TO THE
WORLD'S
BEST
RACING!**



Make Marina Bay Your Race Headquarters

(510) 236-1013 • www.MarinaBayYachtHarbor.com

**FILL YOUR COCKPIT
WITH CREW**



Go to **Latitude 38's**
FREE online crew list at
www.latitude38.com

and join us at our
SPRING & FALL CREW LIST PARTIES

Check our website and
'Lectronic Latitude for info.



ORGANIZED 1896

Pacific INTER CLUB *Yacht Association*

~ ANNOUNCEMENT OF 2015 REGATTAS ~

LIPTON CUP SERIES

Hosted by Oakland Yacht Club • Sunday, June 28

Big Lipton	PHRF 45-99
Larry Knight Perpetual Challenge	PHRF 100-156
Little Lipton	PHRF 157-206
Admiral's Perpetual Trophy	PHRF 207-270

*Skipper's meeting and party Saturday night at Oakland YC.
See www.OYCracing.net for details on this prestigious race.*

YOUTH REGATTA

Hosted by SeqYC, PYSF and BAYS • May 16 & 17

Optimist	Division A	10 & under
Optimist	Division B	12 & under
El Toro	Division C	16 & under
CFJ	Division D	Grades 8-12

*Two boats per division per yacht club.
For more information see www.oycracing.net*

CHISPA

Laser	PICYA Small Boat Perpetual Trophy	All ages
-------	-----------------------------------	----------

One boat per yacht club

Go to www.picya.org for Regatta News

VHF RADIO CHANNEL USES

CHANNEL #	INTENDED USE
16	Distress, safety , calling. Monitored by the Coast Guard and public coast stations.
6	Intership safety purposes and search and rescue (SAR) communications. Not to be used for non-safety matters.
12	Offshore Vessel Movement Reporting System. In use from Pilot Boarding Precautionary Area Approach buoys N, W and S to outer limits of System (N 41 nm, W 29 nm, S29 nm).
13	Bridge to Bridge commercial vessel navigation and safety communications. In use from the Offshore Pilot Boarding Precautionary Area (buoy SF #1 – Sea Buoy) to inside the Bay and throughout the Delta regions.
14	Vessel Traffic Service (VTS). Power Driven Vessels (40+ meters), Passenger Vessels (50+ passengers), Towing Vessels (8+ meters w/tow), Marine Events (committee boat, organizer). Check in, MONITOR , update, check out.
22A	U.S. Coast Guard Communications with USCG stations, vessels and aircraft after contact on channel 13 or 16.
7A, 8, 9, 10, 11, 18A, 19A, 79A, 80A, 88A	Port Operations. Commercial (intership and ship to coast) working channel. Commercial vessel business and operational needs.
9, 68, 69, 71, 72, 77A, 78A	Port Operations. Commercial (intership and ship to coast) working channel. Supplies, repairs, berthing, yacht harbors, marinas. These are the channels used by race committees.
26, 84, 87 27, 28, 86 25, 26, 27, 28 28	Marine Radio-Telephone Operators San Francisco Sacramento, Stockton, Delta North: Bodega Bay to Fort Bragg and 50 miles out South: Santa Cruz to Point Sur and 50 miles out
12, 20, 65A, 66A, 73, 74	Coast Guard Port Operations. Traffic advisory for use by agencies directing movements of vessels in or near ports. Offshore Vessel Movement Reporting System.
WX 1-2-3	Weather (receive only).

Of all the safety equipment on your boat, your VHF radio is probably the most effective and essential. Because VHF uses common frequencies, it's important to remember a few rules of marine radio etiquette:

- Radio checks, which should be performed at least every time you leave your slip, should always be conducted on channel 9, never on channel 16.
- Before hailing another station on channel 16, listen for at least one minute before keying your mic, so as not to “step” on radio traffic that’s already underway.
- Speak slowly and pause for at least a minute between hailing attempts.
- Always start on the “low” power setting.
- Don’t use the radio if you have non-emergency traffic that can be accomplished with a mobile phone.

ALPHA INDEX

Alphabet Soup	14	Euro Marine Trading.....	64
Beer Can Series.....	20-24	Express 27 Fleet	86
Caribbean Circuit.....	36	Express 37 Fleet.....	31
College Sailing.....	80	Golden Gate Yacht Club.....	28
Contacts		Grand Marina.....	74
Associations	14	Hansen Rigging	63
<i>Latitude 38</i>	87	Harken.....	4
PHRF Committee	16	Hogin Sails	26
One Design Fleets.....	31	Island Yacht Club	40
Weather.....	58	Islander 36 Association.....	31
YRA	8	J/105 Fleet #1	21
Yacht Clubs.....	12	J/120 Fleet #5	23
Contents.....	4	KKMI.....	92
Flags	58	Marchal Sailmakers.....	86
Fleet Schedules	30-32	Marina Bay Yacht Harbor.....	89
PHRF Instructions and Info.....	48-57	Mariners General Insurance.....	70
Lake Circuit	72-78	Melges Boat Works.....	25
Marks and Racing Areas	39-46	New England Ropes.....	34
Midwinter Series.....	26-27	Oakland Yacht Club	8
Monthly Calendars.....	59-81	Outboard Motor Shop.....	70
New Equipment List.....	18	PICYA.....	89
One Design Fleets.....	31	Pacific Cup Yacht Club	91
Pacific Ocean Events.....	38	Pettit Paint.....	7
Racing Rules.....	47	Pineapple/Musto, Dubarry and Spinlock.....	58
Season Winners 2014	10	Pineapple Sails	59
Shorthanded Races.....	28	Pirate’s Lair	14
Sunrise/Sunset Times	87	Quantum Pacific	61
Tidal Current Charts.....	82-85	Richmond Yacht Club	19
Tidal Current Predictions		Robichaud Batten System, Inc.....	72
January-June Weekends	86	Sail California	20
July-December Weekends	88	SailSFBay.org	85
VHF Radio Channel Uses.....	90	San Francisco Yacht Club	35
Welcome Letter	6	Santana 22 Fleet.....	31
Women’s Circuit.....	34-35	Sausalito Yacht Club.....	33
YRA Races	49-55	Schaefer Marine	72
Youth Sailing.....	60-70	Seashine.....	80

ADVERTISER INDEX

Alpha Marine Systems	29
Alpha Ropes	41
BVI Spring Regatta.....	36
Bainbridge	27
Bay Area Multihull Assn.....	62
Bay Marine Boatworks.....	9
Bay Risk Insurance	41
Bay View Boat Club.....	71
Berkeley Marine Center	39
Berkeley Yacht Club	62, 76, 80
Boome, Chris, Insurance	32
Boomkicker	24
Butler Rigging.....	79
Coastal Cup	69
Corinthian Yacht Club.....	60
Davis Instruments.....	76
Defender Industries	24
DeWitt Studio.....	81
Dimension Polyant.....	30
Doyle Sails.....	5
Dry Creek Vineyards	43
Easom Racing & Rigging.....	2-3
El Toro Association.....	68
Encinal Sailing Foundation.....	11
Sequoia Yacht Club	43
Singlehanded Sailing Society.....	77
South Beach Yacht Club	73
Spinnaker Cup	87
Stockton Sailing Club	67
Strictly Sail Pacific	17
Sunsail Charters	37
Team McLube.....	33
Tiburon Yacht Club	68
Trans Pac.....	29
Trident Funding.....	75
Twin Rivers Marine Insurance	16
Tylaska	66
UK Sailmakers	50
Ullman Sails - San Francisco & Monterey Bay	13
Vallejo Marina	47
Vallejo Yacht Club.....	65
Waterat.....	87
West Marine - Rigging	12
Westwind Precision Details	35
Whiskeytown Sailing Club.....	74
Wichard Sparcraft, Inc.....	15
Windjammer Yacht Club	60



PACIFIC CUP

JULY 2016 • START NOW

the fun race from san francisco to hawaii

Safety at Sea Seminar

Encinal Yacht Club
May 17th

Pacific Offshore Academy

Richmond Yacht Club
June 13th & October 17th

2016 Pacific Cup

First start July 11, 2016

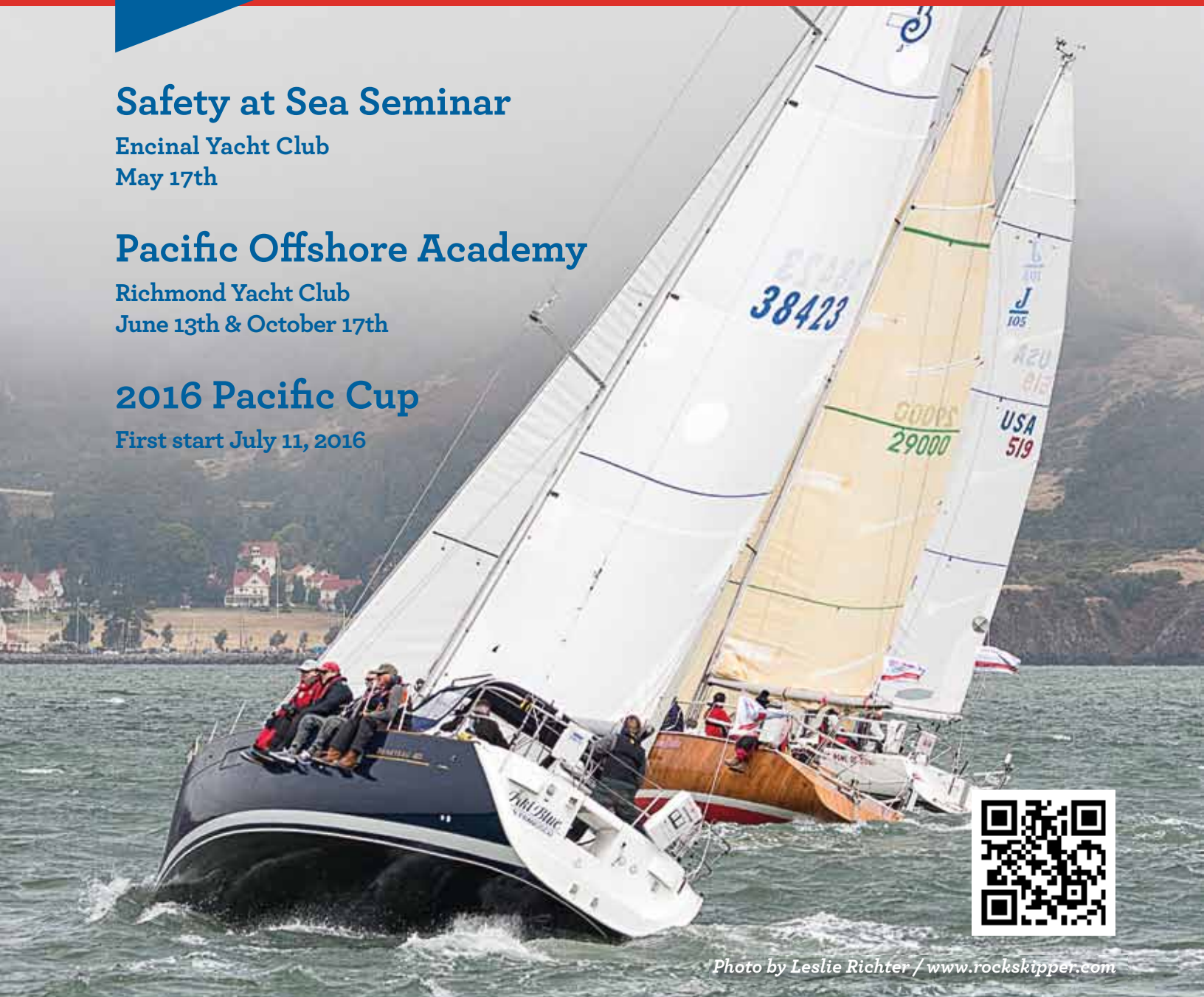

Photo by Leslie Richter / www.rockskipper.com

www.PacificCup.org



MORE SPEED - DELIVERED

HOME

SERVICES

LOCATIONS

STORE

YACHT SALES

GENERAL YARD

HAULS & LOADING

BOTTOM PAINTING
& REPAIR

FINISH PAINTING
& DETAILING

GEL COAT
& FIBERGLASS

WELDING
& FABRICATION

WOODWORKING
& CABINETRY

SYSTEMS & EQUIPMENT

RIGGING

ENGINES

ELECTRONICS

RACING SERVICES



If you are looking for ways to get a little more speed out of your boat, come visit us at KKMI. From the masthead to the keel, our marine professionals can look at your boat with a fresh eye and suggest ways to sail faster without "crashing" the budget.

KKMI is skilled in:

- ▶ Super-Slippery Bottom Jobs
- ▶ Foil Optimization
- ▶ Rig Inspections
- ▶ Life Line Replacement
- ▶ Engine Service*

* Be first at the finish line and the club house!



PT. RICHMOND (510) 235-5564

SAUSALITO (415) 332-5564

WWW.KKMI.COM