

Latitude 38

Latitude 38

VOLUME 436 October 2013

WE GO WHERE THE WIND BLOWS

OCTOBER 2013

VOLUME 436



GRAND MARINA

THERE'S NO BETTER PLACE



TO END A DAY ON THE BAY

GRAND MARINA OFFERS MANY FIVE STAR ACCOMMODATIONS.

Secured tiled restrooms and showers, full service marine center, friendly knowledgeable staff, night security, and a 24-hour free pump-out station, just to name a few.

Stop by to see what you have been missing.



GRAND MARINA

THE BAY AREA'S PREMIERE BOATING COMMUNITY

510.865.1200

Leasing Office Open Daily
2099 Grand Street, Alameda, CA 94501
www.grandmarina.com

- ◆ Prime deep water double-fingered concrete slips from 30' to 100'.
 - ◆ Great Estuary location in the heart of beautiful Alameda Island.
 - ◆ Complete bathroom and shower facility, heated and tiled.
 - ◆ Free pump-out station open 24/7.
 - ◆ Full-service Marine Center and haul-out facility.
 - ◆ Free parking.
 - ◆ Free on-site WiFi.
- And much more...

Directory of Grand Marina Tenants

Blue Pelican Marine	154
Boat Yard at Grand Marina, The	21
Marchal Sailmakers	144
MarineLube	157
New Era Yachts	160
Pacific Crest Canvas	32
Alameda Marine Metal Fabrication	
Pacific Yacht Imports	
UK-Halsey Sailmakers	

Élan - energy, style and enthusiasm

Elan has been a fixture in the Express 37 one-design fleet for a long time, but for relatively new owner Jack Peurach, the ocean races have been particularly rewarding. In 2012, *Elan* won her division in the Pacific Cup - and nobody was more surprised than first-timers Jack and his crew. The 2013 OYRA (Ocean Yacht Racing Association) series has been equally kind to *Elan*, with a string of solid finishes. Jack and his crew placed first in their division at the close of the season.

Elan has had this success with a relatively old set of Pineapple sails that came with the boat, which according to Jack, "miraculously, still look great." It has only been this year that Jack has started to upgrade to a new set - not surprisingly, exactly like the old set ... from Pineapple Sails.

Call us today for an upgrade of your own; for sails designed and built right here in Alameda, California.



PHOTO ERIK SIMONSON/WWW.H2OSHOTS.COM

*Elan**

YOUR DEALER FOR: Musto foul weather gear, Dubarry footwear, and Spinlock Deckwear

Sails in need of repair may be dropped off at
West Marine in Oakland or Alameda.



PINEAPPLE SAILS

Phone (510) 522-2200

Fax (510) 522-7700

www.pineapplesails.com

2526 Blanding Ave., Alameda, California 94501

*Powered by Pineapples

BOAT LOANS

from



Trident Funding

*"a fresh
approach
from people
you can trust"*

In Northern California call
JOAN BURLEIGH
(800) 690-7770

In Southern California call
JEFF LONG
(888) 883-8634

www.tridentfunding.com

CONTENTS

subscriptions	6
calendar	12
letters	22
sightings	70
america's cup finals	84
eye on the bay	92
red bull recap	94
delta doo dah	98
cruising tips, pt. I	102
baja ha-ha profiles, pt. II	108
max ebb: distress sail	114
the racing sheet	118
world of chartering	124
changes in latitudes	130
classy classifieds	146
brokerage	157
advertisers' index	157

Cover: The 34th America's Cup was a thrill ride, all the way down to the 19th race. See page 84 for full coverage of this epic event.

Photo: ACEA / Abner Kingman

Copyright 2013 Latitude 38 Publishing, LLC

Latitude 38 welcomes editorial contributions in the form of stories, anecdotes, photographs – anything but poems, please; we gotta draw the line somewhere. Articles with the best chance at publication must 1) pertain to a West Coast or universal sailing audience, 2) be accompanied by a variety of pertinent, in-focus digital images (preferable) or color or black and white prints with identification of all boats, situations and people therein; and 3) be legible. These days, we prefer to receive both text and photos electronically, but if you send by mail, anything you want back must be accompanied by a self-addressed, stamped envelope. **Submissions not accompanied by an SASE will not be returned.** We also advise that you not send original photographs or negatives unless we specifically request them; copies will work just fine. Notification time varies with our workload, but generally runs four to six weeks. Please don't contact us before then by phone or mail. Send all submissions to editorial@latitude38.com, or mail to Latitude 38 editorial department, 15 Locust Ave., Mill Valley, CA 94941. For more specific information, request writers' guidelines from the above address or see www.latitude38.com/writers.html.

NICOLAS CLARIS



The New Oceanis 38 YOUR BOAT • YOUR RULES Daysailer. Weekender. Cruiser.



NICOLAS CLARIS

**Launches at the
United States
Sailboat Show
in Annapolis
October 10-14
2013**

The new Oceanis 38 can be a **daysailer** that offers an open loft-like feel, a **weekender** that features a 2- or 3-cabin layout and privacy options, extra tables, and fitted galleys, or a **cruiser** with 2 or 3 fitted cabins, a large galley, and a selection of features you choose to configure the boat to your use.

The 38 features a full-length chine and a deep-draft T-shaped keel which provide increased stiffness and stability while reducing heel, and twin rudders for a responsive helm.

Sense 43 46 50 55 **FIRST** 20 25 30 35 40 45 Oceanis 31 34 37 41 45 48 50 55

LAGOON CATAMARANS



380 39 400 421 450 52 560 620

Northern California
Boat Fest
Marina Village Yacht Harbor
Alameda, California

October 3-6 2013
11 am to 6 pm

- Yachts • Seminars
- Music • Food

FEATURED SEMINAR:
Your Boat as a Business
Saturday, October 5
Call for details (510) 236-2633

EXCLUSIVE BROKERAGE AT OUR DOCKS

BENETEAU BROKERAGE

OCEANIS 49	2009	\$325,000
OCEANIS 46	2008	Pending
FIRST 45	2009	\$295,000
OCEANIS 423 2-cabin	2004	\$175,000
OCEANIS 423 3-cabin	2004	\$175,000
FIRST 40.7	2001	\$149,000
OCEANIS 40	2009	\$197,000
OCEANIS 393	2005	\$129,500
OCEANIS 393	2003	\$128,900
OCEANIS 34	2009	\$145,000
OCEANIS 331	2003	Pending
OCEANIS 323	2007	\$79,500
FIRST 25	2013	\$89,000

EXCLUSIVE BROKERAGE

HUNTER 54	1982	\$75,000
ISLAND PACKET 485	2006	\$579,000
CATALINA 470	2005	\$299,000
HUNTER 466	2004	\$249,000

SABRE 452	2002	\$405,000
HUNTER 45DS	2011	\$229,000
JEANNEAU 45	2007	\$250,000
CATALINA 42	2004	\$199,000
TARTAN 4100	2001	\$232,500
DEHLER 41	1998	Pending
ISLAND PACKET 380	2000	\$229,000
ERICSON 38	1988	\$63,000
PACIFIC SEACRAFT 37	1984	\$119,000
CATALINA 36	1996	Pending
FREEDOM 36	1987	\$69,500
ISLANDER 36	1972	\$39,995
ALERION EXPRESS 33	2009	\$189,000
FREEDOM 32	1984	\$39,999
ERICSON 28+	1987	\$28,500

POWER BROKERAGE

OFFSHORE 58	1995	\$795,000
COBALT 263	2002	\$59,000
SEASPORT 24	1999	\$45,900

FEATURED LISTINGS



TARTAN 4100, 2001 \$232,500



HUNTER 45DS, 2011 \$229,000



www.passageyachts.com

TWO LOCATIONS OPEN 7 DAYS

1220 Brickyard Cove Rd
Pt. Richmond, CA
p: 510-236-2633
f: 510-234-0118

1070 Marina Village Pkwy, #101
Alameda, CA
p: 510-864-3000
f: 510-337-0565

POWER & SAIL NEW BOAT SALES • BROKERAGE • CONCIERGE OWNER'S SERVICES • CHARTER PLACEMENT

Don't leave port without'm!

#1



Servo Pendulum/Optional Emergency Rudder

www.selfsteer.com

See over 5000 photos of boats with Windvane installations

Built in the USA - Used Worldwide

See us at the Annapolis Boat Show Booth C-29

We are also the proud manufacturer of:



auto-helm

Auxiliary Rudder/Trimtab, no lines, emergency rudder

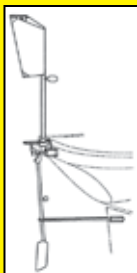

Saye's Rig

Pendulum Trimtab for hydraulic steering/high freeboard

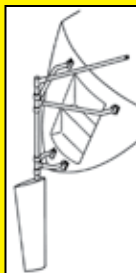

SOS Emergency Rudder

Stand-alone, stows under deck, just like your life raft

All sailing skippers from circumnavigators to recreational cruisers need the silent, reliable extra helmsman that a windvane provides.

No impossible-to-fix electronics, no maintenance...

A 24/7 workhorse at half the price of an installed underdeck autopilot!

We can supply the RIGHT Windvane/Emergency Rudder for your boat



Point Richmond, CA
510.215.2010
888.946.3826
scanmar@selfsteer.com

SUBSCRIPTIONS

YOU CAN ALSO GO TO www.latitude38.com TO PAY FOR YOUR SUBSCRIPTION ONLINE

Please allow 4-6 weeks to process changes/additions, plus delivery time.

eBooks email list. *Free!*

See www.latitude38.com to download the entire magazine for free! Our eBooks are in PDF format, easy to use with Adobe Reader, and also available in Issuu format.

Email: _____

Enclosed \$36 for one year Third Class Postage (Delivery time 2-3 weeks; Postal Service will not forward third class; make address changes with us in writing.)

Enclosed \$55 for one year First Class Postage (Delivery time 2-3 days.)

Third Class Renewal First Class Renewal (*current subs. only!*)

Gift Subscription Card to read from: _____

NOTE: Subscriptions going to correctional facilities, FPO/APO (military), Canada, and Mexico are first class only. Sorry, no other foreign subscriptions.

Name _____

Address _____

City _____ State _____ Zip _____

Phone: () _____ Email: _____

CREDIT CARD INFORMATION MASTERCARD VISA AMERICAN EXPRESS
Min. Charge \$12 Number: _____ Exp.: _____ csv: _____

INDIVIDUAL ISSUE ORDERS Current issue = \$6 ea.

Back Issues = \$7 ea. MONTH/YEAR: _____

DISTRIBUTION

We have a marine-oriented business/yacht club in California which will distribute copies of *Latitude 38*. (Please fill out your name and address and mail it to the address below. Distribution will be supplied upon approval.)

Please send me further information for distribution outside California

Business Name _____ Type of Business _____

Address _____

City _____ State _____ Zip _____

County _____ Phone Number _____

Latitude 38

"we go where the wind blows"

Publisher/Exec. Editor Richard Spindler richard@latitude38.com
Associate Publisher..... John Arndt john@latitude38.com ext. 108
Managing Editor Andy Turpin andy@latitude38.com ext. 112
Editor..... LaDonna Bubak ladonna@latitude38.com ext. 109
Racing Desk racing@latitude38.com ext. 105
Contributing Editors John Riise, Paul Kamen
Special Events Donna Andre donna@latitude38.com
Advertising Sales John Arndt john@latitude38.com ext. 108
Advertising Sales Mike Zwiebach mikez@latitude38.com ext. 107
General Manager Colleen Young colleen@latitude38.com ext. 102
Production/Web Christine Weaver chris@latitude38.com ext. 103
Production/Photos..... Annie Bates-Winship annie@latitude38.com ext. 106
Bookkeeping..... Penny Clayton..... penny@latitude38.com..... ext. 101
Directions to our office..... press 4
Subscriptions..... press 1,4
Classifieds..... class@latitude38.com press 1,1
Distribution distribution@latitude38.com press 1,5
Editorial editorial@latitude38.com press 1,6
Calendar..... calendar@latitude38.com
Other email..... general@latitude38.com



www.latitude38.com
15 Locust Avenue, Mill Valley, CA 94941
Ph: (415) 383-8200 Fax: (415) 383-5816



The fastest and most durable performance sail in the world is now available in a versatile new style for small-to-medium-sized sailboats. **3Di 760m™** is packed with all the 3Di punch you'd expect, but is easier to handle, easier to trim and easier on your wallet. Contact your nearest North representative today and discover how far 3Di can take *your* team.

Game changer

To learn more about 3Di 760m, visit our website at
www.northsails.com/3Di.aspx

3Di **NEW!** 760m

Engineered for durability, designed for performance



Better by Design

Sausalito 415-339-3000
Channel Islands 805-984-8100
Marina Del Rey 310-827-8888
Long Beach 562-795-5488
Costa Mesa Sail Care 949-645-4660
San Diego 619-224-2424
www.northsails.com

ABOVE: J/88 hull #1 flying 3Di 760m mainsail and jib in Newport, RI. Photo courtesy J-Boats



SAIL California

SUMMER INVENTORY CLEARANCE - ALL IN-STOCK BOATS ON SALE!



New for 2013 - Jeanneau 469



New for 2013 - J/Boats J/88



New 2014 Jeanneau 409



New 2014 Jeanneau 379



New 2013 J/Boats J/70



New 2013 J/Boats J/111



2014 Leopard 44



2014 Leopard 48

Alameda • San Diego
Marina Del Rey • Long Beach
Newport Beach

See Over 150 New & Used Boats for Sale

www.CruisingYachts.net

www.SailCal.com

Cruising Yachts
Sail California



Alameda Yacht Sales Office

1070 Marina Village Pkwy,
Suite #108,
Alameda, CA 94501

Phone: (510) 523-8500



'05 Owen Clark 60 \$749,000



'05 Santa Cruz 53 \$CALL



'02 Bakewell 50 \$549,000



'78 Gulfstar 50 \$112,500



'06 Fox 44 \$253,000



'96 JBoats J/130 \$195,000



'04 Tartan 4100 \$315,000



'08 JBoats J/124 \$249,000



'09 Maxwell Cat 40 \$750,000



'04 Catalina 400 \$191,000



'99 Catalina 400 \$169,000



'07 Jeanneau 39i \$178,500



'06 Hunter 38 \$129,000



'98 Catalina 380 \$114,000



'05 Beneteau 373 \$119,500



'91 Hunter 37.5 \$69,900



'86 Express 37 \$69,900



'83 Catalina 36 \$44,900



'04 Catalina 36 MKII \$115,000



'95 JBoats J/105 \$72,000

72' Custom M/S '66.....	\$775,000	35' Hunter '03.....	\$87,500
61' C&C Ketch '72.....	\$199,000	35' J/105 '02 "Oh Mama".....	\$114,900
55' Tayana '88.....	\$249,000	35' J/105 '99 "Danae".....	\$85,000
52' Santa Cruz '99.....	\$495,000	35' J/105 '92 "Vim".....	\$75,000
52' Transpac Custom '03.....	\$395,000	34' Hanse '.....	\$92,500
50' Owen Clarke Open '03...	\$295,000	33' Synergy 1000 '99.....	\$49,000
40' Jboats J/120.....	\$144,900	30' Knarr '61.....	\$60,000
36' Freedom '88.....	\$65,000	30' Scout '80.....	\$49,500
		25' Nautica Wide Body '00.....	\$110,000

Marina Village Boat Fest
October 3-6, 2013
Join Us There!

FEATURED LISTINGS



50' Custom Steel Scow Schooner
Gas Light • 1998
\$595,000



41' Tartan 4100
1999
\$249,000



40' Cookson Farr
1992
\$89,000



36' Beneteau 361
2002
\$109,000



36' Catalina
1986
\$39,500



36' Islander Freeport
1978
\$48,000



33' Hans Christian 33T
1984
\$129,000



30' Cape Dory Cutter
1982
\$32,500

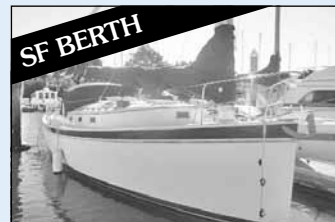

30' Nonsuch Ultra
1989
\$63,800



28' Alerion Express
2000
\$63,000

10 MARINA BLVD., SAN FRANCISCO, CA 94123 • Toll Free: 877-444-5091 • 415-567-8880
FAX (415) 567-6725 • email: sales@citysf.com • website: www.citysf.com

PLEASE VISIT OUR FUEL DOCK AT GASHOUSE COVE MARINA • OPEN 7 DAYS A WEEK • 9AM TO 5PM



Cityyachts

San Francisco's Yacht Broker



Greenline
The Hybrid.
Northern
California Dealer

NEW GREENLINE HYBRIDS



30' Greenline
New! 2014
\$334,620



40' Greenline
New! 2014
\$578,000



57' Bayliner 5788
Pilothouse, 2001
\$549,000



SISTERSHIP

48' DeFever LRC/Trawler
1980
\$175,000



44' Sea Ray 440
Express Bridge, 1997
\$165,000



41' Storebro SRC 400
1990
\$169,000



SF BERTH

39' Sea Ray Sport Fish
Sedan, 1979
\$195,000



34' Bayliner 3488
Command Bridge, 1993
\$130,000



34' Californian Long Range
Cruiser, 1985
\$45,000



30' Carver 300
Aft Cabin, 2002
\$59,900

10 MARINA BLVD., SAN FRANCISCO, CA 94123 • Toll Free: 877-444-5091 • 415-567-8880
FAX (415) 567-6725 • email: sales@citysf.com • website: www.citysf.com

PLEASE VISIT OUR FUEL DOCK AT GASHOUSE COVE MARINA • OPEN 7 DAYS A WEEK • 9AM TO 5PM

Always a Perfect Fit!



Great Gifting Made Easy!

What makes a great gift? Truly, it's the thought that counts! So think about how much you'd like to have a shopping spree at West Marine. Now think about how much the members of your crew would love to have the same opportunity. Get the picture?

It's easy to give everyone on your list a gift they'll love. Just drop by any West Marine store, or go online to westmarine.com and order up gift cards in any amount.

Don't you wish making dreams come true was always this easy?

 **West Marine**[®]
For your life on the water[®]

Follow us on:



We have 17 stores in Northern California,
including our Alameda Sailing Superstore!

Visit www.westmarine.com to find the store nearest you.

CALENDAR

Non-Race

Oct. 1-13 — Impressionists on the Water, an exhibit of boating-inspired art by Monet, Pissarro, Renoir, Signac and others at the Legion of Honor. Info, www.legionofhonor.org.

Oct. 1-Nov. 30 — America's Cup & Historic Racing on San Francisco Bay exhibit at the Maritime Museum, 10 a.m.-4 p.m. Includes historic boats, historic and modern photos, and a rare model of *America*. Open daily with museum admission. Info, www.maritime.org or (415) 447-5000.

Oct. 2-30 — Wednesday Yachting Luncheon Series at St. Francis YC, 12-2 p.m. Enjoy lunch and a dynamic speaker each Wednesday for about \$25. All YCs' members welcome. More info under 'Events' tab at www.stfyc.com.

Oct. 3 — SF2SF Ocean Race, a presentation about the newest around-the-world race by Cree Partridge and Jim Antrim at Corinthian YC, 6:30 p.m. Free. RSVP at www.cyc.org.

Oct. 4-6 — Westsail Owners Rendezvous at San Leandro YC. Guest speaker: Dave King. Would-be owners welcome! Info, www.westsail.org/NCrondy.

Oct. 4-26 — A Salute to the America's Cup art exhibit by BayWood Artists on the Bay at the Bay Model in Sausalito. Info, www.baywoodartists.org.

Oct. 5 — Redwood City PortFest, a free showcase of the waterfront. Live music, kids' activities, food and wine garden. Info, www.rwcportfest.com or (650) 306-4150.

Oct. 5 — Chula Vista Marina Swap Meet, 7 a.m.-noon. Info, boatslips@cvmarina.com.

Oct. 5 — Chantey Sing aboard a historic vessel at Hyde St. Pier, 8 p.m.-12 a.m. Free. RSVP to peter_kasin@nps.gov.

Oct. 5 — Oktoberfest. EYC, www.encinal.org.

Oct. 5, 26 — Sail aboard San Francisco Maritime National Historic Park's scow schooner *Alma*. Learn the Bay's history on this 3-hour voyage, leaving Hyde St. Pier at 1 p.m. \$40 adults, \$20 kids 6-15. Info, www.nps.gov/safr.

Oct. 5-6 — US Sailing Advanced Judges Seminar at St. Francis YC. \$90-\$135. Register at raceadmin.ussailing.org/Judges/Seminar_Calendar.htm.

Oct. 6 — Cal Sailing Club's free introductory sail at Berkeley Marina, 1-4 p.m. Info, www.cal-sailing.org.

Oct. 6 — Inaugural OPB-YC Crew You Regatta for all boats 24 feet and under in the vicinity of Brooks Island and Southampton. Not your typical sausage fest — owners don't drive. Treasure hunt and potluck BBQ raft-up after. Info, www.opb-yc.com/crew-you.

Oct. 6-27 — Free sailing at Pier 40 every Sunday courtesy of BAADS. Info, (415) 281-0212 or www.baads.org.

Oct. 7-11 — Hey, sailor, it's Fleet Week. The air show and naval fleets have been canceled, so this year's activities revolve around Humanitarian Assistance Disaster Response. See www.fleetweek.us.

Oct. 10 — Are you a single boatowner needing crew? The Single Sailors Association has crew to help sail your boat. Monthly meeting at Ballena Bay YC in Alameda, 6:30 p.m. Info, www.singlesailors.org or (510) 239-7245.

Oct. 10 — Behind-the-scenes presentation on America's Cup TV technology by Stan Honey and Ken Milnes at Encinal YC, 7 p.m. Free. Info, www.encinal.org or www.alameda-yachtclub.org/AYCevents.

Oct. 10-14 — 44th Annual United States Sailboat Show, a.k.a. the Annapolis Boat Show. Info, www.usboat.com.

Oct. 13-18 — Round the Rocks Flotilla, a cruise around Catalina & Santa Barbara Islands led by Capt. Holly Scott of *Charlie's Charts*, \$150/boat. Info, info@charliescharts.com.

Oct. 14 — Celebrate Columbus' famous sail today.

Oct. 16 — Downwind Marine's Offshore Communication

FARALLONE YACHT SALES



2014 CATALINA 355

JUST ARRIVED!



2014 RANGER 31 FLYBRIDGE



2014 RANGER 31 SEDAN



We're the proud dealer of Ranger Trailerable Tugs, and Catalina and Tartan Sailing Yachts – all Made in America brands.
Please visit us at www.faralloneyachts.com for details.

LIST WITH US – GET ONE MONTH FREE RENT!

OPEN BOAT WEEKEND OCTOBER 12-13 • COME WALK OUR DOCKS!



2010 Beneteau 36.7 *Briney Dancer* \$133,000



2011 Catalina 470 *Liquid Assets* \$365,000



2009 Catalina 309 *Amokura* \$93,500



2011 Ranger 29, *Two Knights* \$224,000



2009 Ranger 25 *Sea Sea Rider* \$105,000



2007 Catalina 34 MkII *Ruach* \$115,900

Preowned Catalina Yachts at Our Docks

Catalina 470 MkII, 2011.....	\$365,000
Catalina 42 MkII, 2005.....	REDUCED! 178,000
Catalina 42, 1989.....	84,500
Catalina 400, 2001.....	REDUCED! 159,000
Catalina 36 MkII, 2001.....	REDUCED! 95,000
Catalina 34 MkII, 2007.....	115,900
Catalina 34, 1986.....	REDUCED! 40,995
Catalina 309, 2009.....	93,500
Catalina 30, 1988.....	NEW LISTING! 28,000
Catalina 30, 1979.....	NEW LISTING! 13,950

Catalina 28 MkII, 1997.....	32,000
Catalina 250, 2005.....	23,900
Preowned Sailing Yachts	
Norseman 447, 1984.....	REDUCED! 169,000
Beneteau 36.7, 2010.....	NEW LISTING! 133,500
Ericson 32, 1970.....	REDUCED! 26,900
New Ranger Tugs (base price)	
Ranger 31 Sedan Tug, 2014.....	JUST ARRIVED! 269,937
Ranger 31 Flybridge, 2014.....	NEW MODEL YEAR! 279,937
Ranger 29 Tug, 2014.....	NEW MODEL YEAR! 229,937

Ranger 27 Tug, 2012.....	159,937
Ranger 25SC Tug, 2012.....	129,937
Preowned Ranger Tugs	
Ranger 29 Tug, 2011.....	224,000
Ranger 25 Tug, 2010.....	105,000
Ranger 25 Tug, 2009, includes trailer.....	105,000
Ranger 21 Tug, 2008.....	39,000
Preowned Power Yachts	
Stephens 70 Classic Motor Yacht, 1966.....	1,100,000
Ocean Alexander 44, 1991.....	REDUCED! 139,000



1070 Marina Village Pkwy
Alameda, CA 94501
(510) 523-6730



Engineered Apparel



Great looking gear with performance built right in!

Every item of West Marine apparel is designed and built with boating in mind. From the architecture of each garment, to the most innovative technical fabrics and thoughtful construction detailing, these clothes are designed to work "out there" on the water. And the best part? Every garment is priced to deliver superior value. Visit us today, at our stores or at westmarine.com, and see for yourself!

West Marine[®]
For your life on the water[™]

We have 17 stores in Northern California, including our Alameda Sailing Superstore!
Visit www.westmarine.com to find the store nearest you.

CALENDAR

Training seminar series kicks off with 'Using Your Marine SSB' by Gordon West & Shea Weston, 5:30-9:30 p.m. \$25 each or \$30/couple. All seminars at Downwind Marine unless noted. **10/17:** 'SailMail Training' by Jim & Sue Corenman and Shea Weston, 8:30 a.m.-4:30 p.m. at Pt. Loma Assembly Hall, \$50/\$75; **10/17:** 'Radar Made Simple for Cruisers' by Terry Sparks, 5:30-8:30 p.m., \$25/\$30; **10/18:** 'Icom M802 Made Simple for Cruisers' by Terry Sparks, 5:30-9:30 p.m., \$25/\$30. RSVPs recommended. Info, www.downwindmarine.com.

Oct. 18 — Sail under the full moon on a Friday night.

Oct. 18 — Full Moon Sail aboard the schooner *Seaward* in Sausalito, 6-8 p.m. \$50. Info, www.callofthesea.org.

Oct. 19 — Baja Ha-Ha Welcome to San Diego Party at Downwind Marine, 12-4 p.m. Info, www.baja-haha.com.

Oct. 19 — Pacific Offshore Academy prep seminar #2 at Richmond YC, 1-5:30 p.m. Perfect for anyone planning to sail to Hawaii, especially in the Pacific Cup. Free for Pac Cup skippers, \$20 for others. Pre-registration strongly advised! Info, www.pacificcup.org.

Oct. 21 — Downwind Marine's Evening Cruisers' Seminar Series kicks off with 'Tips & Tricks for Life Afloat' by Wendy Hinman, 6-8 p.m., \$3, backdoor at Downwind Marine. More seminars at same time and location. **10/22:** Charts Past, Present & Future (Capt. Ann Kinner); **10/23:** Cruising Mainland Mexico & PPJ Prep at Puerto Vallarta Marina (Dick Markie); **10/24:** Surviving a Haulout (CF Koehler); **10/25:** Life at Sea—What Works, What Doesn't (Capt. Dale Parshall); **10/28:** Philosophy of Ground Tackle (Capt. Holly Scott); **10/29:** Safety Lessons for Offshore Cruising (Bruce Brown); **10/30:** Mexican Liability & International Health Insurance (DeAnne Amancio); **10/31:** Outboard Motor Care (Tom Teevin); **11/1:** Cruising the World—A Bluewater Family Adventure (Bob & Gail French); **11/4:** What's New for Cruising Mexico (Capt. Pat Rains); **11/5:** 12-Volt Cruising (Barry Kessler); **11/6:** Off the Beaten Path in Mexico (Mark & Emily Fagan); **11/7:** TBA; **11/8:** Planning for Cruising (Capt. Ann Kinner). Info, www.downwindmarine.com.

Oct. 25 — Boatrides & Barbecues fundraiser for Cass Gidley Marina & Sausalito Community Boating Center at Dunphy Park, 4:30-6:30 p.m. Free boat rides, music & BBQ. Info, www.cassgidley.org.

Oct. 25 — Presentation by Marc and Doreen Gounard on their circumnavigation on their catamaran *Imani* at Sausalito Public Library, 7:30 p.m. Free. Info, www.ci.sausalito.ca.us.

Oct. 26 — SF Maritime's Sea Music Concert Series continues aboard *Balclutha* at Hyde St. Pier, 8-10 p.m. Next up: Serre l'Écoute. \$14 per concert. Info, www.maritime.org or (415) 561-6662 ext. 21.

Oct. 26 — Maritime Crafts for Kids at SF Maritime National Historical Park's Hyde St. Pier, 3-4 p.m. Free. Info, john_cunneane@nps.gov or (415) 447-5000.

Oct. 27 — Baja Ha-Ha Halloween Costume Party & BBQ in San Diego West Marine parking lot. May the best pirate win!

Oct. 28 — Baja Ha-Ha XX Cruisers Rally to Cabo San Lucas starts from San Diego! Info, www.baja-haha.com.

Oct. 31 — Dress as your favorite sailor for Halloween.

Nov. 3 — Daylight Saving Time ends.

Nov. 3 — Sailing program forum to discuss how to grow the sport, organized by Alameda Community Sailing Center at Oakland YC, 1 p.m. Info, atariane@sailalameda.org.

Nov. 7 — High Tech Sail Making by North Sails' Bill Pearson at Corinthian YC, 6:30 p.m. Free. RSVP at www.cyc.org or (415) 435-4771.

Racing

Sept. 29-Oct. 5 — International Folkboat Regatta. RYC,

THE FINEST SAILS BEGIN WITH THE BEST SAILCLOTH

GET READY FOR FALL SAILING!

- Furling Sail UV Covers
- Repair, Replacement and Sail Washing

Our patented woven Vectran® sailcloth performs like the laminates with the durability of Dacron®, especially in roller furling applications. In fact, Vectran® is lighter, lower stretch, and retains its shape over a longer life than any sailcloth we've ever offered to cruising sailors. That's because Hood Vectran® is woven, not laminated to Mylar® film. And you can be sure that each sail we roll out is built by hand, with the same care and craftsmanship that has been the Hood hallmark for 50 years. To discuss your sailcloth needs – whether our state-of-the-art Vectran® or our soft, tight-weave Dacron® – give us a call today.

HOOD Sails & Service

HOOD New Sails

HOOD Sail Repairs

HOOD Furling Conversions

HOOD Free Pickup & Delivery



SAILMAKERS



Chesapeake

Jim Fair's Outbound 46
with Hood Vectron
Full Batten Mainsail,
140% Genoa, and
Solent Jib

PHOTO COURTESY
SWIFTSURE YACHTS
www.OutboundYachts.com

HOOD SAILMAKERS 465 Coloma Street, Sausalito, CA 94965

Call Robin Sodaro (800) 883-7245 (415) 332-4104 Fax (415) 332-0943 hoodsails@aol.com

Visit our website for Special Online Discount Pricing... www.hoodsailmakers.com

Your PFD Source!



Over 100 styles for every kind of boater and every kind of boating!

We take your safety on the water seriously. Wearing a Personal Flotation Device has proven to be the single most important thing you can do to enhance your safety aboard. We stock more styles of Personal Flotation than any other boating supply source!

No matter what kind of boating you do, West Marine has the right PFD to help you stay safe and comfortable on the water.

Earn up to 4% on your purchases as a West Advantage Rewards Member!

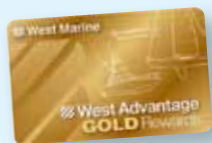

Become a member of the most rewarding loyalty program in boating and earn points for every dollar that you spend with us. In addition, you'll get members-only savings, discounts on boat charters and

boating magazine subscriptions, volume purchase discounts and more. Sign-up today online or at any store location.

West Marine[®]
For your life on the water™

Visit our stores! For the location nearest you, or to shop 24/7, go to www.westmarine.com

CALENDAR

www.richmondyc.com.

Sept. 30-Oct. 5 — Melges 24 Worlds. SFYC, www.sfyf.org.

October, 1983 — It Was Thirty Years Ago from the feature article 'America's Cup':

It warms our journalistic heart to think that Red Smith, the legendary sport columnist for *The New York Times*, must have faced this situation, too. We're sitting here with the printer breathing down our necks for our pasted-down flats, but the story — no, *The Sailing Story of the Century!* — doesn't have a conclusion yet. The seventh and deciding race of the 1983 America's Cup race won't be over until the pressmen turn on their machines. What do we do, Red? What do we do?

Whether or not the Aussies, led by the dashing John Bertrand and the frumpy, puckish Ben Lexcen, can finally wrest the Auld Mug from the grasp of the New York YC and their dogged defenders on *Liberty*, this will always be remembered as the year the America's Cup became a real yacht race. No more lopsided, ho-hum four-zip walkovers by the Yanks in their technically superior and more ably sailed yachts. After four challenges and \$16 million, Perth tycoon Alan Bond came up with an effort equal to and in some ways superior to the Americans. No longer can media journalists fall back on Ring Lardner's hackneyed comment that watching yachts race was as exciting as watching grass grow.

Newsflash! It appears now, minutes after *Australia II* crossed the finish line ahead of *Liberty* in the seventh and final race, that the 132-year winning streak has been broken. Barring protests or acts of God, the America's Cup will be removed from its case at the New York YC and carried to its new home at the Royal Perth YC on Pelican Point, Crawley Bay. The unthinkable has happened.

Conner seemingly had the race in the bag, crossing the starting line eight seconds ahead in the light winds. The red-hulled *Liberty* held comfortable leads for the first four legs, rounding the second weather mark by 57 seconds. *Australia II* went farther east on the run, finding more breeze and surging ahead to a 21-second lead by the time they reached the final turn. From there, skipper John Bertrand and his Waltzing Matildas zealously guarded their gains to take the winner's gun.

Radio stations flashed the news around the world. History had been made. For patriotic Americans, this was a bitter blow. The Stars and Stripes no longer rule the seas. For patriotic Australians, this was the closest to heaven on earth they will ever get. Three cheers for the winners — they did a fine job.

Oct. 5 — Kay & Dave Few Regatta. CPYC, www.cpyc.com.

Oct. 5 — Oktoberfest. OYC, www.oaklandyachtclub.net.

Oct. 5 — Shorthanded Races. TYC, www.tyc.org.

Oct. 5-6 — YRA Season Closer. Island Tour on Saturday, Crazy 8 on Sunday. CYC, www.yra.org.

Oct. 5-6 — Sausalito Cup, a J/105 match race. SYC, www.sausalitoyachtclub.org.

Oct. 5-6 — Fall Dinghy Regatta. SCYC, www.scyc.org.

Oct. 5-6 — Vice Commodore's Cup. HMBYC, www.hmbyc.org.

Oct. 6 — Red Bra Regatta. SBYC, www.southbeachyc.org.

Oct. 6 — El Toro Stampede. RYC, www.eltoroyra.org.

Oct. 6 — Fall Series #3. FLYC, www.flyc.org.

Oct. 11-13 — IOD NAs. SYC, www.sausalitoyachtclub.org.

Oct. 11-18 — International Knarr Championship. SFYC, www.sfyf.org.

Oct. 12 — Jessica Cup, fleet racing for big woodies. StFYC, www.stfyf.com.



YACHTS FOR SALE - NEW & USED

WWW.JK3YACHTS.COM

SOLD, SOLD, SOLD - WE NEED BOATS TO SELL - CALL US TODAY TO GET YOUR BOAT LISTED & SOLD!



2006 65' J/65
MAITRI \$ Call for price



2002 50' Beneteau Farr 50
FRENCH KISS \$240,000



2007 49' Chuck Burns Schooner
SIR EDMUND \$635,000



2001 48' J/145
JEITO \$324,000



2001 47' Bavaria 47
OVERSEAS \$169,000



2000 46' J/46
QUESTAR \$349,000



2006 43' J/133
TANGO \$ 349,000 - **Reduced**

ADDL SAIL.....

- 1988 70' Santa Cruz 70 \$380K
- 2005 52' TP52 \$375K
- 2014 50' HANSE 505 **CALL**
- 2014 44' HANSE 445 **CALL**
- 2000 42' J/42 \$209K
- 2008 41' X Yachts X41 \$275K
- 2002 41' Hunter 410 (TX) \$139K
- 2001 40' C&C 121 \$195K
- 2000 40' J/125 -Warrior \$389K
- 2010 39' Jeanneau 39i (TX) \$206K
- 1987 37' J/37 - **Reduced** \$69K
- 1995 36' Sabre 362 (TX) \$159K
- 2006 36' J/109 \$179K
- 2006 35' J/105 Fresh Water \$99K
- 2001 35' J/105 Light Use **CALL**
- 1994 35' J/105 \$115K
- 2006 33' Cross Curent 33 \$169K
- 1998 33' Seawind Cat \$139K
- 1995 32' Pacific Seacraft \$107K
- 2005 32' Beneteau 323 **SOLD**
- 2011 31' J/95 **SOLD**



1998 40' Lobster Boat
SARI ANN \$140,000



2004 35' J/109
KNOTS 2 \$149,000



2000 35' Tartan 3500
OUR TRADE \$124,000

ADDL POWER.....

- 2008 44' Renzo Rivolta **SOLD**
- 2003 44' Hinckley Talaria \$625K
- 1992 40' Sea Ray Express \$57K**
- 2014 34' BackCove 34 **CALL**



2005 40' Raider Aquapro RIB
SURF RAIDER \$218,000



2009 30' Raider 9m RIB
SPORT \$69,000 w trailer



2005 28' Protector CC T Top RIB
ZUNI \$80,000 w trailer

DEALERS FOR: BACK COVE YACHTS Dehler Hanse J Southern California & Hawaii BOATS SABRE Yachts



2013 SABRE 38 SE w/Pod Drives



The All New DOWNEAST 37



2013/14 Hanse 415



2014 48' SABRE 48 SE

San Diego: 619.224.6200

Newport: 949.675.8053

Alameda: 510.227.2100

Houston: 281.957.9788



HOGIN SAILMAKERS



Call Today
(510) 523-4388

HOGIN SAILMAKERS

- New racing and cruising sails
- Roller furling conversions/new sun covers
- Full service and repair loft
- Boom and canvas covers
- ATN spinnaker socks
- Strongtrack
- Sails are manufactured in our Alameda loft

Call us today to discuss your sail inventory.

510.523.4388

1801-D Clement Avenue, Alameda, CA 94501

sales@hoginsails.com

www.hoginsails.com

CALENDAR

Oct. 12 — Joan Storer Regatta. TYC's women skippers' race. TYC, www.tyc.org.

Oct. 12 — Los Gatos Challenge Race. SeqYC, www.sequoiayc.org.

Oct. 12 — Fall Series #2. SSC, www.stocktonsc.org.

Oct. 12 — Fall Series #4. FLYC, www.flyc.org.

Oct. 6, 13, 27 — Berkeley Chowder Series runs every Sunday through March, except on Berkeley Midwinter weekends. BYC, www.berkeleyyc.org.

Oct. 12-13 — PHRF Championship. MPYC/SCYC, www.scyc.org.

Oct. 12-13 — Vanguard 15 Fleet Championships on Tomales Bay. InvYC, www.invernessyachtclub.org.

Oct. 13 — Laser Short Course Championship at RYC. Info, nburke@skysail.com or (415) 601-7483.

Oct. 19 — YRA Yankee Cup & YRA-ODCA Champion of Champions. IYC, www.yra.org.

Oct. 19 — BYC's Oktoberfest Cup, featuring two buoy races for multis and an around-Alcatraz race for monohulls. Info, www.berkeleyyc.org.

Oct. 19 — Corkscrew Slough Regatta. SeqYC, www.sequoiayc.org.

Oct. 19 — South Bay Championship. SeqYC, www.sequoiayc.org.

Oct. 19 — Twin Island Race #3. SYC, www.sausalitoyachtclub.org.

Oct. 19-20 — Franks Tract Regatta. Andreas Cove YC (Owl Harbor), www.andreascoveyc.org.

Oct. 19-20 — Leukemia Cup Regatta, PHRF and one design racing to benefit the Leukemia & Lymphoma Society. Hosted by SFYC, featuring keynote speaker Sir Ben Ainslie. Info, www.leukemicacup.org/gba.

Oct. 19-20 — Joe Logan (Merces), Calvin Paige (Stars) and Albert T. Simpson (sportboat) Regattas. StFYC, www.stfyc.com.

Oct. 20 — Lady Skipper's Race. PresYC, www.presidiyachtclub.org.

Oct. 20 — Fall Series #5. FLYC, www.flyc.org.

Oct. 22 — Stanford and Cal sailing teams duke it out on the water in the Big Sail. StFYC, www.stfyc.com.

Oct. 26 — Round the Island Race. SFYC, www.sfyyc.org.

Oct. 26-27 — Great Pumpkin Regatta, a Halloween tradition. Also serves as the Islander 36 Nationals. RYC, www.richmondyc.org.

Oct. 26-27 — Fall Dinghy & Olympic Classes. StFYC, www.stfyc.com.

Oct. 26-27 — San Francisco Cup for Catalina 34s. SBYC, www.southbeachyc.org.

Oct. 26-Nov. 2 — 27th Annual Pro-Am Regatta on Virgin Gorda, hosted by Bitter End YC. Info, www.proamregatta.com.

Oct. 27 — Fall SCORE #3. SCYC, www.scyc.org.

Nov. 2 — Summer's Last Gasp. HMBYC, www.hmbyc.org.

Nov. 2 — Midwinter #1 (Manuel Fagundes Seaweed Soup Regatta). GGYC, www.ggyc.org.

Nov. 2 — Red Rock Race. TYC, www.tyc.org.

Nov. 2 — Fall Series #3. SSC, www.stocktonsc.org.

Nov. 2-3 — Club Boat Series #1. StFYC, www.stfyc.com.

Nov. 2-3 — Perry Cup/Kelp Cup. MPYC, www.mpyc.org.

Nov. 3 — Midwinter #1. SYC, www.sausalitoyachtclub.org.

Nov. 3 — Jack & Jill+1, the woman-skippered triple-handed race on the Estuary. IYC, www.iyc.org.

Nov. 9 — Winter #1. SeqYC, www.sequoiayc.org.

Nov. 9 — Turkey Shoot. LWSA, www.lwsailing.org.

CONGRATULATIONS

2013 Rolex F40 World Champions Alberto Rossi and Team



2014 Rolex F40 World Championship September 17-20
St Francis Yacht Club, San Francisco. www.farr40.org

San Diego March 14-17 (Midwinters)
Long Beach May 18-21 (Rolex North American Championship)
Marina del Rey June 18-21 (Cal Cup)
Santa Barbara July 16-19 (West Coast Championship)
San Francisco September 11-14 (Rolex Big Boat Series)

Photo: Rolex/Daniel Forster



WHALE POINT MARINE & HARDWARE CO.

A FAMILY OWNED & OPERATED BUSINESS FOR THREE GENERATIONS
 **ACE Hardware**
 MARINE PARTS & ACCESSORIES, PLUS A COMPLETE HARDWARE STORE

Go to WhalePointMarine.com for additional discounts!

JOHNSON Toilet



NOW \$149⁹⁹

TROJAN & CENTENNIAL Batteries

MARINE DEEP-CYCLE BATTERIES

 24TM • 85amp..... **NOW \$99⁹⁹**
 27TM • 105amp..... **NOW \$119⁹⁹**
 6 Volt..... **NOW \$149⁹⁹**
 8D • 12 Volt..... **NOW \$189⁹⁹**
 *Price with trade-in of old battery of equal size.

CANVAS BUCKET

Very handy bucket to have on your boat. Barely takes up any space... simply fold down to store.



List \$24.99
NOW \$21⁹⁹

DECK BRUSH with Handle

Extra long handle (5ft) with aluminum no-rust, threaded tip.
Now \$13⁹⁹



HORSESHOE BUOY & M.O.B. POLE

USCG Approved

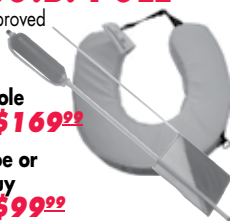

M.O.B. Pole **NOW \$169⁹⁹**
 Horseshoe or Pony Buoy **NOW \$99⁹⁹**

DELUXE BOSUN'S CHAIR

Hard bottom seat. Large SS D rings let you snap in shackle, and tie in a safety line.



NOW \$119⁹⁹

CRAFTSMAN Multi-Tool



Cordless **NOW \$89⁰⁰**
 With Cord **NOW \$79⁰⁰**

SEADOG 5' Folding Ladder

- Ladder becomes stiffer as weight is applied
- Supports 300lb
- Corrosion resistant plastic
- Bottom rung sinks below surface



List \$44.99 • **NOW \$29⁹⁹**

205 Cutting Blvd, Corner of 2nd, Richmond
510-233-1988 • FAX 233-1989

Mon-Sat: 8:30am - 5pm • Sun: 10am - 4pm • whalepoint@acehardware.com

Go to www.WhalePointMarine.com for additional discounts!

CALENDAR

Nov. 9-10 — Club Boat Series #2. StFYC, www.stfyc.com.
Nov. 9-10 — Midwinters #1. BYC, www.berkeleyyc.org.
Nov. 9-10 — Opti Winter #1. SFYC, www.sfyc.org.
Nov. 10 — Midwinter #1. IYC, www.iyc.org.
Nov. 13 — YRA Year-End Trophy Party. Details TBA.

Remaining Summer Beer Can Regattas

CAL SAILING CLUB — Year-round Sunday morning dinghy races, intraclub only; Thursday evening JY15 races through October. Gary Farber, racing_chair@cal-sailing.org.
COYOTE POINT YC — Every Wednesday night through 10/2. Jim Maishin, (650) 793-0741 or regatta@cpyc.com.
LAKE TAHOE WINDJAMMERS YC — Every Wednesday night through 10/16. Steve Katzman, (530) 577-7715.
MONTEREY PENINSULA YC — Sunset Series, every Wednesday night through 10/2. Rak Kumar, rakk@copper.net.
SANTA CRUZ YC — Wet Wednesdays through 10/30. Laser Fridays: 8/16. Info, (831) 425-0690 at scyc@scyc.org.
SEQUOIA YC — Every Wednesday night through 10/9. Dan Lockwood, (650) 326-6783 or dan@hnlockwood.com.

Please send your calendar items by the 10th of the month to calendar@latitude38.com. If you're totally old-school, mail them to Latitude 38 (Attn: Calendar), 15 Locust Avenue, Mill Valley, CA, 94941 or fax them to us at (415) 383-5816. But please, no phone-ins! Calendar listings are for marine-related events that either are free or don't cost much to attend. The Calendar is not meant to support commercial enterprises.

October Weekend Tides

date/day	time/ht.		time/ht.	
	HIGH	LOW	HIGH	LOW
10/05Sat	0020/5.3	0548/1.4	1216/6.0	1825/0.1
10/06Sun	0108/5.2	0624/1.7	1250/6.1	1907/-0.2
10/12Sat	0723/4.8	1231/2.7	1825/5.4	
	LOW	HIGH	LOW	HIGH
10/13Sun	0102/0.2	0819/5.2	1345/2.2	1941/5.4
10/14Mon	0202/0.3	0906/5.5	1446/1.6	2052/5.4
	HIGH	LOW	HIGH	LOW
10/19Sat	0037/5.2	0547/1.6	1208/6.2	1832/-0.3
10/20Sun	0126/5.1	0627/2.0	1240/6.1	1911/-0.3
10/26Sat	0652/4.5	1206/3.0	1716/4.6	
	HIGH	LOW	HIGH	LOW
10/27Sun	0008/0.9	0739/4.7	1312/2.7	826/4.4

October Weekend Currents

date/day	slack		max	
	slack	max	slack	max
10/05Sat	0216	0451/3.6E	0817	1109/3.3F
	1407	1709/4.6E	2049	2346/3.8F
10/06Sun	0303	0535/3.4E	0852	1146/3.2F
	1440	1751/4.9E	2132	
10/12Sat	0217	0522/3.2F	0847	1102/2.2E
	1438	1719/2.2F	2010	2319/3.9E
10/13Sun	0322	0629/3.3F	0943	1210/2.5E
	1550	1835/2.4F	2125	
10/14Mon	1033	0026/3.8E	0421	0728/3.4F
	2234	1315/3.0E	1652	1944/2.9F
10/19Sat	0219	0449/3.2E	0816	1104/3.2F
	1357	1701/4.7E	2053	2354/3.9F
10/20Sun	0307	0531/2.9E	0856	1142/2.9F
	1434	1741/4.7E	2136	
10/26Sat	0141	0443/2.5F	0808	1016/1.7E
	1408	1634/1.4F	1920	2227/3.1E
10/27Sun	0236	0540/2.5F	0858	1114/1.9E
	1512	1740/1.5F	2027	2324/2.9E

Your full service boat yard.



Home | Services | Rates

Gallery | Links | Green Yard

CLICK
OUR
RATES!

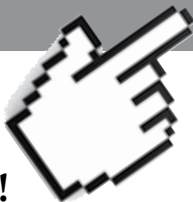

NEW WEBSITE:
www.boatyardgm.com
We're just a 'click' away.



We're happy to
share them.
(No hidden charges!)



CLEAN AND GREEN
Now – the latest in environmental
filtration technology. Protecting you,
our workers and the Bay.

IT'S SIMPLE!

Call The Boat Yard at Grand Marina for the Lowest Bottom Prices!

~ COMPARE US WITH THE COMPETITION ~

- Prop and Shaft Work
- Mast & Rigging Repair
- Fiberglass & Blister Repair
- Gelcoat Repair
- Gas & Diesel Engine Service
- LPU Hull & Topside
- Electrical Repair & Installation

CALL FOR A RESERVATION

(510) 521-6100 • Fax (510) 521-3684

2021 Alaska Packer Place, Alameda



LETTERS

↑↓ OUR EXPERIENCE AT AQUATIC PARK

On our way from San Diego to British Columbia in 2010, we sailed into San Francisco Bay and anchored at Aquatic Park.



COURTESY EMERALD STEEL

'Emerald Steel's dinghy fit right in at Hyde St. Pier.

After anchoring, I scanned the beach with binoculars looking for a place to land our dinghy. I noticed an old dory on the beach next to the pier, so I thought, "Hm-mmmmm, looks

like a good spot." So after rowing in, that's where we left our dinghy. We then hopped onto the pier and noticed all of these beautiful classic wooden vessels.

After spending about two hours casually strolling up and down the pier admiring all the ships, we decided to return to our boat. But when we jumped back down to the beach, we were stopped by two security guards who asked us what we were doing. We explained that we were anchored out in Aquatic Park and had left our dinghy there on the beach. Only then did we learn that we'd been inside the San Francisco Maritime Museum, which is meant to be entered from the street via the front gate after you pay an entry fee. After explaining that our boat, a replica of Joshua Slocum's famous *Spray*, has a



COURTESY EMERALD STEEL

And 'Emerald Steel' fit right in at Aquatic Park.

somewhat historical link, the guards agreed with a laugh to allow us to keep our dinghy there for the next two days.

For whatever it's worth, we had a fun and pleasant experience in Aquatic Park, with our dinghy being properly watched over by security guards.

Julius & Suzie Hanak
Emerald Steel, Spray replica
San Diego

↑↓ 10 FEET WOULD HAVE BEEN ACCEPTABLE

At 12:30 p.m. on August 29, we were motorsailing WSW on San Francisco Bay aboard *Salcera* on starboard tack at 5.5 knots. Oracle Team USA's catamaran had been heading NNW, and then tacked downwind, heading east. They came at us at about 35 knots, and their chase boat was not on station.

Salcera held her course, and within seconds Oracle, also on starboard, was upon us. We watched in silence as she took our stern by just three feet! Such a small distance at such high speed was not corinthian seamanship. Ten feet would have been acceptable, but three feet was negligent. Had either vessel changed course even slightly, *Salcera* would have been destroyed and crew on both boats would have been killed.

There had been no radio alerts that boats were to clear the area, as there were for the next day. We are excited that the America's Cup came to San Francisco Bay, but we think the Oracle sailors need to be more respectful of others.

Marla Forrest
Salcera, Catalina 34
San Francisco Bay



MEET THE
ULTRAFEED
U.S. SAILBOAT SHOW

ANNAPOLIS, MARYLAND

October 10-14, 2013 • Tent H, 24-27

800.348.2769 | www.sailrite.com

Patents: #6499415, #7438009



WERE YOU THERE?

SVENDSEN'S CELEBRATES THE WINNERS AND ALL WHO ENJOYED USING THEIR BOATS TO WATCH THE CUP.



CHRISTINE WEAVER

“Svendensen’s provides the highest quality repair services year round. Helping our customers enjoy moments on the Bay like this are why we enjoy this business.”
-Sean Svendsen, Owner

Boat Works	510.522.2886
Chandlery & Rig Shop	510.521.8454
Metal Works	510.864.7208
Dinghy & Trailer Sales	510.521.8454
General Inquiries	info@svendsens.com

1851 Clement Avenue, in the Alameda Marina

Call 510-522-2886 or request a boat yard service appointment online at www.svendsens.com

LETTERS

Marla — If your boat was missed by only three feet, we'd agree that it was too close for safety. On the other hand, we personally would have been thrilled to be on a boat that an AC72 skirted at such a short distance at such a high speed. It's unlikely we'll see the likes of those monsters again anytime soon.

⇅ WHAT WOULD STERLING HAYDEN SAY?

I've learned a lot of things about sailing from reading *Latitude 38* and *Lectronic Latitude*. The July 22 *Lectronic* article titled *What a Great TransPac!* not only mentioned a little of overall winner *Dorade's* colorful history, but also educated me as to the correct pronunciation of her name. I'd always heard people pronounce it as 'Dor-aid', not 'Dor-odd'.

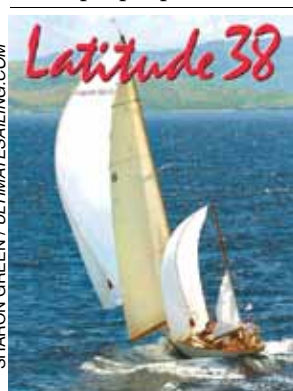

That got me searching the internet for a little history of dorade vents. Lo and behold, this is what Wikipedia had to say about them: "The first appearance of dorade boxes was on the Olin Stephens-designed *Dorade*, a yacht built in 1929 for ocean racing. As originally built, *Dorade's* vents led directly below, but this was found to allow water below, and the vents were modified in the early 1930s."

Wind-funneling dorades were named after 'Dorade'.

How interesting. Now if you can just get people to follow Sterling Hayden's admonishment that a boat's main living — and, of course, drinking — area, usually found between the port and starboard settees, is a 'saloon' and not a 'salon', which is where one would have one's hair done.

Jon Hafstrom
Sea Horse, Island Packet 35
San Francisco

Jon — We'd always thought it was 'Dor-aid', too, but when we met Fremont owner Matt Brooks at the Voiles de St. Barth in the islands two years ago, he kept referring to her as 'Dor-odd'. He pays the bills and wins the races, so we're pronouncing it the way he does. Of course, if you went to a chandlery and asked for a 'Dor-odd' vent, you'd probably get an odd look.

Just before going to press, we bumped into Matt while watching the America's Cup races. "You can call her 'Dor-odd' as I do, or you can call her 'Dor-aid', just call me for lunch," he said.

As for saloons and salons, pronunciations and spelling change with time. Most sailors in the United States who use 'saloon' predate the Boomer generation.

⇅ YOU'RE SUCH A TOSSER

I saw the *Lectronic* article about the epic battle between the Tosser — the Wanderer — and the Hoarder — Doña de Mallorca — aboard *Profligate*. Did you know that in the United Kingdom, 'tosser' more or less means the same thing as 'wanker'.

Nick Burke
Secretary, Laser District 24

Nick — The Wanderette, our second wife, was a bird from London, so we knew that. We deliberately used the term Tosser for the sake of a self-deprecating double entendre we hoped might win a chuckle or two.

JUMP ON IT!

90 Days of Savings and Great Prizes

THERE'S NEVER BEEN A BETTER TIME TO BUY A NEW SAIL!

For a limited time, Quantum USA is offering the best prices of the year on all cruising, racing and one design sails. And when you request a free quote for new sails, you are automatically entered to win great prizes offered by Quantum and marine partners including Ronstan, Gorilla Rigging, Harken, Velocitek, Zhik, Marlow Ropes, and many more!

VISIT US ONLINE AT QUANTUMSAILS.COM
FOR MORE INFO ABOUT OUR FALL PROMOTION!

Offer valid from 8/01/13 -10/31/13.

QUANTUM PACIFIC 510-234-4334

Jeff Thorpe | sanfrancisco@quantumsails.com
Will Paxton | wpaxton@quantumsails.com

QUANTUM LONG BEACH 562-799-7444

Todd & Nancy Wheatley
twheatley@quantumsails.com

QUANTUM NORTHWEST 206-634-0636

Dan Kaseler | dkaseler@quantumsails.com

QUANTUM SOCAL 562-624-4325

Sam Heck | socal@quantumsails.com
Scott Poe | spoe@quantumsails.com
Richard Parlette | rparlette@quantumsails.com
Todd Downey | tdowney@quantumsails.com

QUANTUM SAN DIEGO 619-226-2422

Eric Heim | eheim@quantumsails.com
Mark Reynolds | mreynolds@quantumsails.com
George Szabo | gszabo@quantumsails.com



Toll Free: 888.773.4889
For more information please visit us online at:
QUANTUMSAILS.COM

Promotion valid for residents of the US only from 8/1/13 to 10/31/13.
Please visit www.Quantumsails.com for more details.

follow us:   



MARINA BAY YACHT HARBOR

**DEEP WATER HARBOR
EASY ACCESS**

*Easy Access by
Land or Sea!*



We have a deep slip for you.



**One of the deepest marinas
on San Francisco Bay:
12-ft depth minimum!**

(510) 236-1013

www.MarinaBayYachtHarbor.com

LETTERS

↑↓ DOÑA'S LINGERING REPUTATION IN MALLORCA

We had a thoroughly enjoyable evening on our Catalina 42 last year with the Tosser and the Hoarder after the Tosser gave his presentation at the California YC. Having the two of you aboard was one of our boating highlights. As we mentioned that night, we would soon put our beloved sailboat *Breez'n*, which

we had owned for 18 years, up for sale. She sold in two weeks to a lovely couple from the Richmond YC, where she lives today.



LATITUDE / RICHARD

It's the yin and yang of life. Hoarders and tossers living in harmony . . . or something.

When we'd last hauled her for a bottom job in January of 2012, the lift operator told me *Breez'n* weighed 29,000 lbs — about 9,000 lbs, or one-third, more than her designed displacement. I nearly fainted. After recovering, I proclaimed that *Breez'n* was going on a diet. Marci, being a hoarder, had other ideas.

But with the sale of our boat, we had to remove all our gear and stores before the new owners could take over. When *Breez'n* was hauled for the survey, the operator told me she was down to 24,000 lbs. We'd removed nearly 2½ tons from our boat! I couldn't believe it.

We've since bought a lot up in Poulsbo, which is across Puget Sound from Seattle, where we're building a home. Because the wind is so light and fluky up here, and the currents so strong, we're going to buy — gasp! — a powerboat. Both of us have lived up here before, so we have a idea of what we will be going through during the winter months, but we still intend to go boating year 'round. In fact, I'll be buying a Harbor 20 sailboat by Schock to sail out of Port Madison. She'll be perfect for sailing on the long and pleasant summer evenings.

P.S. We had a wonderful time in Palma de Mallorca, Spain, last November. Doña de Mallorca will like the fact that she's still remembered there after all these years.

Garry & Marci Willis
ex-*Breez'n*, Catalina 42
Poulsbo, Washington

↑↓ "I PREFER THE TERM 'GATHERER'"

Tossing versus hoarding is a common battle between the sexes! I identify myself as a Gatherer as opposed to a Hoarder.

Christine Hagen
Avventura, KP-44
Jackson

↑↓ "HI, MY NAME IS KATIE..."

Hoarding is the only reason that I would want to get a bigger boat. I'm enrolled in Hoarders Anonymous, but have yet to graduate.

Katie Prather
Miss Teak, Morgan 45
Dana Point

↑↓ GENDER ROLES

Marina and I go through the same Tosser versus Hoarder battles on our Swan 44 *Mykonos*. Women must be hoarders because I like to toss.

Myron Eisenzimmer
Mykonos, Swan 44
San Anselmo



Racing

Beer Can Racing: Wed. until Oct. 9, Piano bar after the race
South Bay Championship: Oct. 19
Winter Series:
#1 Nov. 9, #2 Dec. 7
Redwood Cup Series:
#1 Nov. 23, #2 Dec. 21

Other Activities

Port Fest: Oct. 5
Cruise-outs:
• San Francisco YC: Oct. 12-13
• Angel Island: Nov. 29 - Dec. 1
• Encinal YC: Dec. 14-15

Social

Drop-in Dinners*: Oct. 11, 25; Nov. 1, 15; Dec. 13
Racer's Ribs Dinner*: Oct. 26
Installation Dinner*: Nov. 9
Holiday Party*: Dec. 20
* Members, Guests and Reciprocal Club Members Only Events



**SEQUOIA
YACHT CLUB**

441 Seaport Blvd.
Redwood City, CA
37° 30.144' N / 122° 12.702' W

Club Cruise-ins Welcome

MEMBERSHIP OPPORTUNITIES NOW AVAILABLE!

www.sequoiayc.org

Southern California's **ONLY** all-sail boat show!



PROGRESSIVE
Strictly Sail® LONG BEACH

October 24–27 • Shoreline Village at Rainbow Harbor

New & brokerage sailboats | Sailing gear & accessories | Charters, travel & services



Plus sailing seminars, hands-on, on-the-water sailing clinics
& demos, sailing simulator and much more!

SAVE \$2 ON ADULT ADMISSION

www.StrictlySailLongBeach.com

Visit StrictlySailLongBeach.com, click tickets and enter code **Lat38** to receive \$2 off one full-price adult admission ticket. Limit one per customer. Non-transferable. No duplications, copies or facsimiles accepted. No cash value. Not redeemable for cash or credit. Not valid at box office. Limit one per family.

PROGRESSIVE www.StrictlySailLongBeach.com



Pacific Yacht Imports



2002 TAYANA 48 DECK SALON

Absolutely ready to go
NOW!

\$390,000



1983 TAYANA 55
\$200,000



1983 DON BROOKE 80
\$450,000



1983 SLOCUM 43
\$159,000



2003 CATALINA 400
\$192,000



2001 HUNTER 380
\$105,000



1987 NONSUCH 36
\$89,900



2003 CATALINA 350
\$119,500



1996 HUNTER 336
\$52,000



1987 NONSUCH 30
\$61,500



1985 GULF 32
\$44,000

SISTERSHIP

www.pacificyachtimports.net

Grand Marina • 2051 Grand St., Alameda, CA 94501
Tel (510) 865-2541 • tayana@mindspring.com

LETTERS

Readers — Myron and Marina will be doing their fifth Ha-Ha this month.

↑↓ WATER, WATER EVERYWHERE...

In June of 2004, my wife Jennifer and I celebrated our 10th wedding anniversary by sailing out the Gate for Hawaii — and right into the teeth of a gale. Our boat was a beautiful but slow Vagabond 47 ketch. I've done two Ha-Ha's on trimarans, and will be doing this fall's on our new trimaran, so *Latitude* probably thought I only dabbled in fast boats.

After Jennifer flew home from Hawaii, four friends and my dad crewed on the trip home. A week from San Francisco, we ran out of water. Part of the reason was that my dad had apparently been taking baths. Yeah, the Vagabond had a tub.

We sailed another week without water and low on rations before we got back to the Bay. A year later I sold the Vagabond to buy a couple of rockets: a Moore 24 and a Corsair 31 trimaran. While taking all our stuff off the Vagabond, I opened a seldom used locker in the cavernous main salon — to find it absolutely packed with bottles of Hawaiian Springs water!

Paul Martson

Orange, Contour 34 trimaran
Pierpont Performance Sailing
Ventura

↑↓ NOT QUITE 99 BOTTLES OF BEER, BUT CLOSE

My biggest fear during our South Pacific cruise was that we'd run out of toilet paper, which would have been gross. My husband Mike moaned every time I came home from the store with another case of toilet paper. I justified it by explaining how handy it would be when something was rattling in the middle of the night — just stuff a roll of toilet paper in the rattle area.

When we finally got back to Redondo from Hawaii, Mike removed all the rolls of TP that were still on the boat. It was then that we learned we'd crossed the Pacific and back with 88 rolls of unused toilet paper.

Robin Stout

Mermaid, Aleutian 51
Redondo Beach / La Cruz, Mexico

↑↓ IN CASE WE HAVE TO ABANDON THE HOMELAND

My father purchased an Alberg 35 sloop new in 1965, and I have been in charge of her since 1996. When I took over, I figured that I would need whatever Dad had needed on the boat. But over the years I have learned differently, as I have removed 40-lb anchors, gallons and gallons of booze — in the 1960s nobody wanted to be caught short of booze — 60 lbs of stainless bolts and nuts, and the oddest of all, six rusty and swollen half-gallon cans of Campbell's soup. Bless those folks at Campbell's for using such good cans, as half gallons of clam chowder all over the inside of a lazarette would have been awful.

When I asked my father why he'd put all the soup on the boat, he replied, "Just in case we have to abandon the homeland." Go figure. These days it's a couple of MREs for emergency food. Old habits die hard, especially these days.

Molly Pruyne

Alberg 35
Richmond YC

↑↓ DON'T TOSS THE DINGHY ANCHORS

It's been a few years since our family stopped in Malaysia during our circumnavigation, but digging around in our boat recently, I found several tins of curried tuna and tinned ham

THE DOYLE DIFFERENCE

**2013 Transpac
Winners!**
Congratulations to
Frank Sloopman and crew,
1st Place Div. 1, R/P 63
Invisible Hand

- :: Uncompromising Attention to Detail
- :: Unparalleled Customer Service
- :: Unlimited Possibilities



DOYLE

www.doylesails.com

DOYLE SAN FRANCISCO

**Bill Colombo
510-523-9411**

DOYLE SO. CALIFORNIA

**Bob Kettenhofen
949-645-5388**

The latest generation of racing yachts are demanding Doyle Sails for their ultimate performance and unmatched durability. Creating sails that can win the first race and continue to outperform the competition after many races demands the very best design and engineering expertise, the finest materials, and the ongoing support for which Doyle is known.

Better Engineered Sails.
Designed to Win, Built to Last.



South Beach Harbor is a great way to experience San Francisco. Boats of all sizes are welcome in our protected deepwater harbor. Bring your boat to South Beach and enjoy all the attractions of the city.



Two guest docks for boats up to 125'
20 guest berths up to 50'
Casual and fine dining nearby
Adjacent to AT&T Park
Easy access to transportation
24 hour security
Free pump-out stations



For Reservations:
415.495.4911 (x1111)
fax: 415.512.1351
www.southbeachharbor.com

LETTERS

that we'd bought there. But the Tosser on *Profligate* may want to keep two of the five dinghy anchors he discovered, as a dinghy anchor was the only thing we had stolen during our circumnavigation.

Emma Mather
Blue Sky, DownEast 45
Redondo Beach

↑↓DON'T MAKE GENERALIZATIONS

Some women, for example me, are Tossers, while some men, including my partner Craig Shaw, are Hoarders. Go Tossers, go! But just remember to hide the garbage, because the Hoarders always check.

Jane Roy
Adios, Columbia 43
Portland, Oregon

↑↓SPARES FOR SPARES

I'm with Doña the Hoarder. I say it's better to have something and not need it than to not have something you need. How are you going to fix things without spare parts?

Craig Shaw
Adios, Columbia 43
Portland, Oregon

Craig — Carrying critical spare parts that can't easily be obtained while cruising is one thing, de Mallorca's hiding 75 lbs of pasta aboard Profligate is another.

↑↓TWO PEAS IN A POD

I always knew there was a reason that my husband Rob and Doña de Mallorca got along so well. I had to toss about 50 lbs of moldy rice and beans when I moved aboard! And you should see how many broken screwdrivers he has tucked away — "Just in case." We needed a bigger boat just to store all the crap we'll never use.

LaDonna Bubak
Gazelle, Wauquiez Centurion 47
San Rafael

↑↓MANGO MADNESS

As I recall, my 'Mango Man' Wayne and I helped impose a similar diet on *Profligate* years ago. We're now doing the same on our Hughes 45 cat *Capricorn Cat*. If we don't use something in three months, it goes on the dock for someone else.

Mango Man is the Hoarder, I am the Tosser. But only yesterday Jim Milski, who just circumnavigated with his Schionning 49 cat *Sea Level*, found a muffler and some dinghy wheels in the dumpster at our Sierra Point Marina in Brisbane. "You gotta have these," Jim said to the Mango Man. And the Mango Man put them on our boat. It's an ongoing battle for me.

Carol Baggerly
Capricorn Cat, Hughes 45
Brisbane

↑↓MORE ON ALDEBARAN

I could not agree more with *Latitude's* response to the letter by Hayden Brown, whose 70-ft schooner *Aldebaran* sank, with many people aboard, after hitting the Richmond Breakwater. Brown subsequently pleaded for succor.

After one of last year's AC World Series races, Brown and *Aldebaran* nearly ran me down on my 30-ft sloop *Adagio*. I had been proceeding under sail on starboard toward the Cityfront when *Aldebaran* approached under power off my port bow. Yet Brown refused to yield, as was required of him

Come Visit Us Today!

SOUTH BEACH SAILING CENTER

at the
beautifully renovated Pier 40 in San Francisco



Another Happy Customer

"I like the work you did, and, more importantly, my wife approves!"
—Mr. Belmonte



415.543.1887



nbmc@earthlink.net • www.northbeachmarinecanvas.com

Liz Diaz,
Master Fabric Craftsman

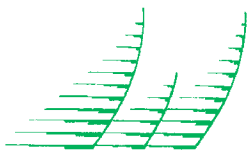

Westwind

Washing • Waxing • Varnishing

If Oracle Team USA uses us to detail their Protectors, Naiads and Water Wizards ...so should you!



(415) 661-2205

Serving the entire Bay Area for more than 25 years

Pier 40, South Beach on the Embarcadero • San Francisco

Call Toll Free **888-828-6789**

westwinddetailing@sonic.net

www.boatdetailing.com



South Beach Riggers

**DO IT ONCE.
DO IT RIGHT.**

PERIOD.

- Mast
- Rigging
- Fabrication
- Hydraulics
- Insurance Work
- More...

www.SouthBeachRiggers.com

415.331.3400

Come see us in Sausalito

399 Harbor Dr., Sausalito, CA 94965

8am - 5pm M - F



Adjacent to South Beach Harbor and AT&T Park • Close to dozens of fantastic restaurants and shops

Yacht owners trust

Pacific Crest Canvas

for the best in design, service and quality.

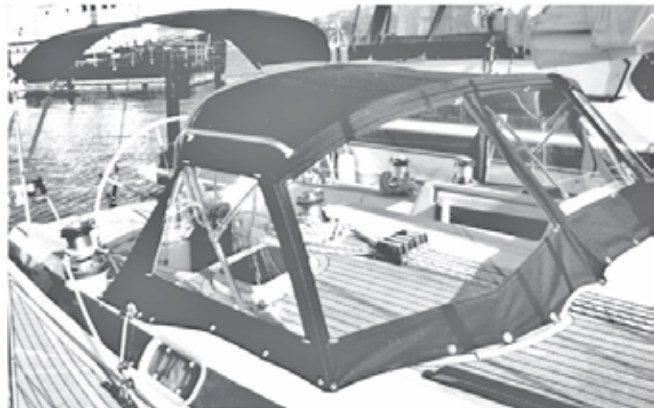

We strive to make our products the
Highest Quality at the Best Prices

Specializing in:

Baja Awnings

Lightweight and waterproof
Durable and easy to launch
Multiple side screen configurations

Coastal Dodgers

Affordable designs
High quality materials
Superior workmanship

Cruiser's Awnings

Easy setup off your dodger
Flies with no bulky frame
Includes shade screens

Offshore Dodgers

Welded aft handrail
Bolt-on side handrails
Lexan windshields



www.pacificcrestcanvas.com

Located in Grand Marina
2021 Alaska Packer Pl., Ste. 13
Alameda, CA 94501

Open Mon.-Fri. 8-4
Sat. by appointment
510-521-1938

LETTERS

by the Rules of the Road.

I think that the view George Hale expressed in his August letter, that Brown coming a cropper was karma, is correct. That, plus the fact Brown took so many people sailing while not having insurance, speaks volumes.

Jon Price
Tiburon YC

Readers — We received several angry phone calls from a woman who accused us of "hitting a man in his 70s when he's down." We understand her point of view. We also sympathize with Brown, whose boat sank as a result of her being driven onto the jetty, probably ending his sailing days. And we sympathize with Brown's wife, who subsequently suffered an injury that required her to be hospitalized. However, we think these possible considerations are negated by the evidence that Brown's angry encounter with George Hale was not an isolated incident.

In addition to the letter from Jon Price above, another Latitude reader wrote us about a similar incident with Brown and Aldebaran last October. The man and two friends were sailing his small sailboat near the Richmond Jetty, when they saw Aldebaran, under power and with many people aboard, approached. Despite being required to yield, Brown and Aldebaran reportedly missed hitting the small sailboat by what the skipper on another boat nearby estimated to be about one foot.

We're told that Brown had been driving Aldebaran, and after the near miss he screamed at the people on the other boat. He then left the schooner's helm to sit down on the boat's stern, arms defiantly folded over his chest. According to the owner, it was about 10 seconds before anyone took the helm of the schooner.

One of those on the small boat was a retired harbor master, who advised the owner to report the incident to the local harbor master. The owner didn't, but says he now regrets it.

About a week later, the owner says he was driving to Brickyard Cove with another friend, when he saw Brown working on Aldebaran at a private dock. The owner went to talk to Brown, and explained that he'd been on the boat Aldebaran almost ran down. Brown is said to have demanded to know if the man had come to fight or come to sue. When Brown saw that he had a friend with him, he asked if he'd been brought along to beat up Brown. The friend was 70 years old.

There is a place for sympathy, but when we receive a minimum of three reports in a year of someone with a much larger boat apparently endangering much smaller boats in separate incidents, while almost proudly admitting to having no insurance, we don't believe we can ignore it.

Fortunately, nobody was hurt in any of the incidents. We wish Brown good luck in trying to sell his salvaged boat and moving to Florida, and we hope his wife recovers quickly.

↑↓PASS THE VEGEMITE!

I brought the current *Latitude 38* to our good mate Bob Mackie when we visited him and Annie Brennan aboard their canal yacht *Nellie*, which is moored in Paris. As always, he was enjoying it thoroughly — until he read Jim and Kent Milski's disparaging comments about the food in Australia. Given that the food on *Nellie* was as good as, if not better than, everything we ate while in Paris, I have to sympathize. Not only are Aussies Bob and Annie some of the best cooks ever — which is one of the reasons we are thrilled that they are going to do the Baja Ha-Ha with us aboard our sailboat *Compañera* this fall! — but with my six-plus months of traveling in Australia, I have to agree with Bob that the comment was pure rubbish!

CRUISERS!

HEAD FOR DOWNWIND MARINE

Cruiser Events for Everyone – Check www.downwindmarine.com

OFFSHORE COMMUNICATIONS SEMINARS

WED., THURS., FRIDAY (OCTOBER 16-18) • RADIO & RADAR

Location: Downwind Marine, 2804 Cañon Street, San Diego

Cost: \$25/person or \$30/couple – cash or check at the door.

Time shown below. Check-in at 5PM for all.

Space Limited – Reservations recommended!

Wednesday – Gordon West and Shea Weston

USING YOUR MARINE SSB 5:30PM - 9:30PM

For reservations, email sheaw@offshoreoutfitters.com

Thursday – Terry Sparks

RADAR MADE SIMPLE FOR CRUISERS 5:30PM - 8:30PM

Reservations: www.made-simplefor-cruisers.com/help-training

Friday – Terry Sparks

Icom M802 MADE SIMPLE FOR CRUISERS 5:30PM - 9:30PM

Reservations: www.made-simplefor-cruisers.com/help-training

THURSDAY, OCTOBER 17 • SAILMAIL TRAINING

Location: Pt. Loma Assembly Hall, 3035 Talbot Street, San Diego

Cost: \$50/person or \$75/couple – cash or check at the door

Presented by Jim & Sue Corenman and Shea Weston

Time: 9AM-4PM (check-in at 8:30 AM)

Reservations recommended. Email sysop@sailmail.com

TWO DAYS of CRUISER FUN at DOWNWIND MARINE STORE DISCOUNTS plus VENDOR FAIRS & FOOD

SATURDAY STORE HOURS 8:30AM - 5:00PM

SATURDAY, OCTOBER 19 • BAJA HA-HA WELCOME BBQ

Baja Ha-Ha sailors meet other cruisers and bring a dish to share!

We supply hot dogs, chili and sodas for ALL customers. Noon - 4PM.

SATURDAY, NOVEMBER 2 • CRUISER KICK-OFF BBQ

Cruisers meet other cruisers and bring a dish to share!

We supply hamburgers and sodas for ALL customers. Noon - 4PM.

*For Fall Schedule,
Click EVENTS at*

www.downwindmarine.com

Tune to Cruisers' Net

Ch. 68 WHX369 • 8:30 AM Weekdays

“CRUISING DOWNWIND” EVENING SEMINARS

Back Door at Downwind Marine

2804 Cañon Street

Monday-Friday at 6PM

Doors open at 5:45PM

\$3/person



Monday, October 21 – Author Wendy Hinman

Tips & Tricks for Life Afloat

Tuesday, October 22 – Capt. Ann Kinner

Charts – Past, Present and Future

Wednesday, October 23 – Dick Markie

Info on Mainland Mexico & Puddle Jump

Thursday, October 24 – CF Koehler, Koehler Kraft

Surviving a Haul Out

Friday, October 25 – Author Dale Parshall

Life at Sea, What Works...or Not

Monday, October 28 – Capt. Holly Scott

Tips and Techniques in Using Ground Tackle

Tuesday, October 29 – Bruce Brown, USCG Trainer

Offshore Safety to Know Before You Go

Wednesday, October 30 – Amancio & Chrispeels

Travel Liability and Health Insurance News

Thursday, October 31 – Tom Teevin, Educator

Outboard Motor Care in Mexico

Friday, November 2 – Authors Bob & Gail French

18 Endless Summers of Sailing

Monday, November 4 – Capt. Pat Rains

What's New for Cruising Mexico

Tuesday, November 5 – Barry Kessler

Onboard Power to the Cruiser! 12 Volt Tips

Wednesday, November 6 – Mark & Emily Fagan

Off the Beaten Path in Mexico – Where to Go

Thursday, November 7 – CF Koehler, Koehler Kraft

Maintaining Your Diesel Motor

Friday, November 8 – Capt. Ann Kinner

Planning for Cruising – The Info Part



THE CRUISER'S CHANDLERY PERFORMANCE SAILING GEAR

2804 Cañon St., San Diego • (619) 225-9411



MARINA AMENITIES

- Full service harbor master's office
- Waterfront dining
- Free WiFi access
- Guest facilities with restrooms, showers and dressing rooms
- Water sport rentals
- Surveillance and electronic controlled gates
- Individual water hook ups
- Garbage and recycling disposal



Sausalito's Finest Marina

85 LIBERTY SHIP WAY, #205, SAUSALITO, CA 94965

415•331•5550

FAX 415•331•8523

www.schoonmakermarina.com

LETTERS

P.S. Love your magazine!

Susan Flieder
San Diego

↑↓ A STONE IN MY DECK SHOE

I have just read the interview with Jim and Kent Milski with interest. One point he made put a little stone in my deck shoe, and prompts my reply. His vast and sweeping statement "Of course even the best Aussie food isn't very good" took my breath away. In my experience, even the worst Aussie food is better than the unhealthy, fat-laden food in the United States.



KRAFT FOODS

Maybe Robert has a point.

as your taste buds, have been a little off.

Another small point. Yes, the Aussie dollar is high now, but when I did a circumnavigation in 2001, the Aussie dollar bought 52 cents U.S. So Jim and Kent, your timing, as well

Robert Mackie
Nellie Dick, Dutch Barge
Paris, France

↑↓ THE VERY VARIABLE COST OF CRUISING

I would like to have written more often in the past because I've been cruising for 25 years, but I didn't pay attention in school. This letter is so long that I guess it could qualify as a rant, but I want everyone to 'be real' about what it costs to own a boat and go cruising. I've read reports in *Latitude* about how inexpensive it can be to cruise, and how little this guy or that couple spent per month. But what people include or don't include as part of the 'cost of cruising' is so subjective that it's not really the true cost. I don't think this helps cruisers who are just starting out.

I'm a 50-year-old who is cruising my third boat, a 1977 Tayana 37. I left Fiji in 2006, and have been surfing in Indonesia as much as I can handle for part of each year. I spend the rest of the year in Thailand and Malaysia. My boat is pretty close to the bottom of the scale when it comes to boats that I see cruising the oceans, but let me run down my expenses to show everybody what it has cost me.

I paid \$53,000 for my Tayana when I bought her in Fiji in 2005. My first refit in Fiji cost a little less than \$35,000. The chainplates were \$1,000; rigging \$5,000; sails \$6,000; SSB \$2,000; new thru hulls \$1,000; a small autopilot \$1,000; refrigeration \$2,000; toilet \$500; dinghy \$2,500; two outboards \$3,500; anchor windlass and chain \$2,500; EPIRB \$1,000; two-month haulout \$1,500; paint job \$2,000.

I later sailed to Australia, where I spent \$30,000 on an additional refit. Twenty-five thousand of it was for a new diesel, prop and shaft, as the originals were 33 years old and had died before Darwin. A big autopilot and radar were another \$5,000.

I then reached Thailand, where I spent nearly \$50,000 on my third refit. It was \$4,000 for self-tailing winches; \$2,500 for roller furling, jib cars and track; \$1,000 for new stainless; \$7,000 for all new exterior teak; \$5,000 for refrigeration; \$2,500 for a stove with oven; \$1,500 for an alternator and regulator; \$500 for an electrical panel; \$1,000 for solar panels; \$1,000 for batteries; \$1,000 for an inverter; \$3,000 for 10 coats of varnish for the entire inside and outside of the boat; \$1,000 for painting the deck; \$3,000 for Treadmaster

PHOTO ERIK SIMONSON/WWW.H2OSHOTS.COM

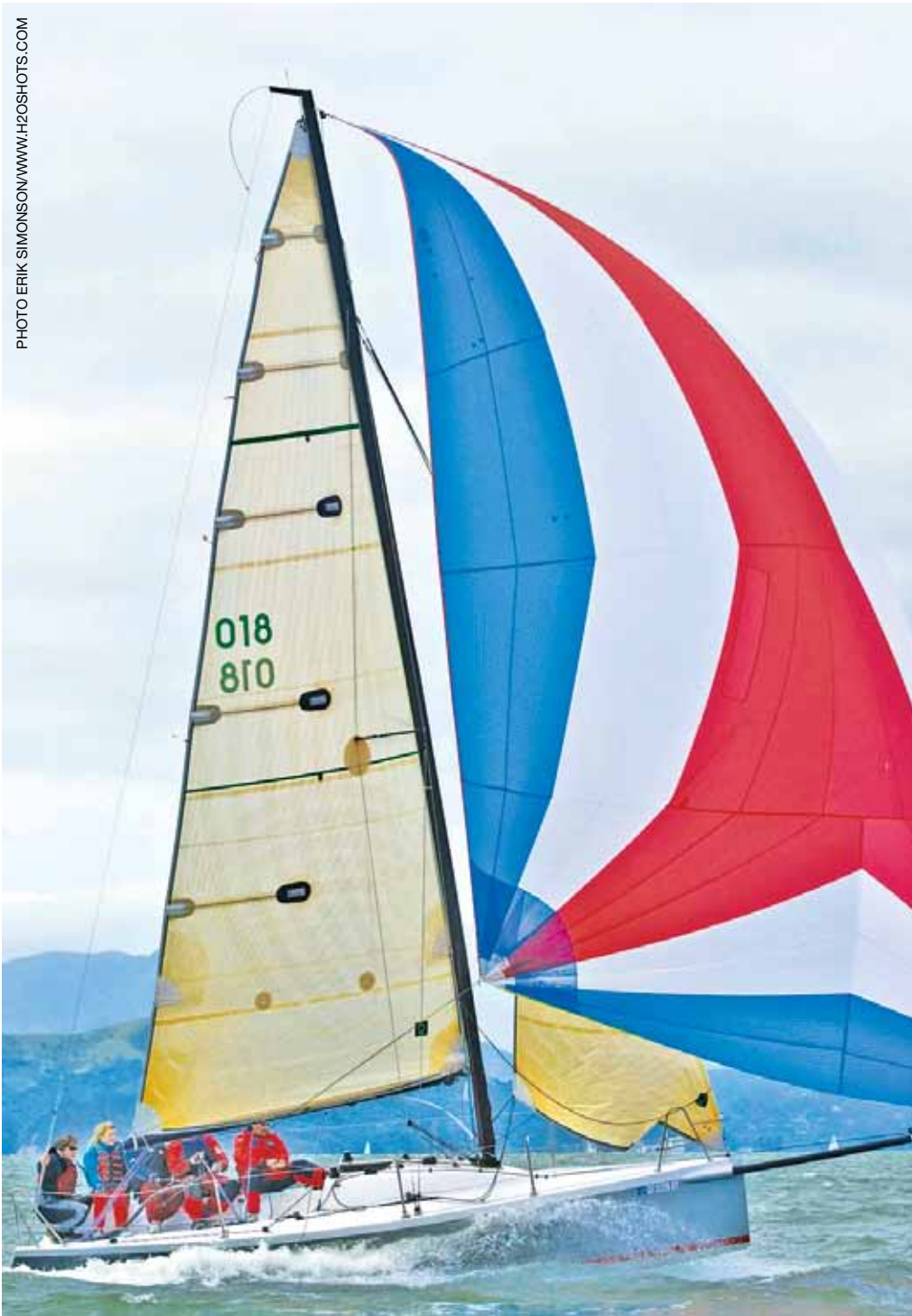

The Sailor's Boatyard, Bay Marine Boatworks is a full-service boatyard in the full sense of the word. We offer a complete range of services at prices lower than the competition, and provide an accurate estimate up front. From bottom painting to complex fiberglass repair work, you'll find that we can handle all your sailboat maintenance and repair needs.



PROJECTS



The Oyster 82 *Darling* was stolen and run up on the beach. Bay Marine Boatworks got the call to haul her in our 100-ton Travelift and ship her back to the manufacturer.

PROJECT MANAGER



Kim Desenberg has done it all in boat repair. Call him for a consultation on your next haulout.

FULL SERVICE BOATYARD



310 W. Cutting Blvd.
Pt. Richmond, CA
(510) 237-0140
www.baymarineboatworks.com

WHEN THE STATUS QUO IS THE STATUS SLOW

TRIM FASTER POINT HIGHER

With Harken's double-acting hydraulic backstay adjuster.

"We thought, 'Why stick with the status quo? Let's go with something innovative to make our integral stand above the rest.' The result was the first ever double-acting hydraulic backstay adjuster."

- Robbie Young,

Harken Hydraulics Manager

One tool
Installs
captive
pins

*Easy viewing
from the cockpit;
Analog gauge at top
of cylinder adjusts
to 4 positions

Reduce windage
with internal pressure
tube design

*Two times faster than
single-acting pumps.
Push/pull handle
provides continuous
oil delivery

*Pressure-release knob
cannot be overtightened
by hand; prevents damage
to valve

3 ways to attach stainless
handle: permanent,
semipermanent, nonlocking

*Feature is Exclusive to Harken

NOW IN 4 SIZES!

Fits 5.5 to 9.5 mm wire (7/32 to 3/8 in).

HARKEN®

DON'T SETTLE FOR LESS

www.harken.com



LETTERS

for the deck; \$1,000 for a television, DVD and stereo; \$500 for a chartplotter; \$5,000 for another cheap paint job; \$5,000 for various things such as epoxy, bottom paints, thinners and stuff; \$3,000 for a five-month haulout, and \$2,000 for an apartment for five months.

I did all my own work except for the engine installation and stainless. I did a lot of wood repairs inside, such as five new bulkheads and some cosmetic stuff. Now my boat looks good and is in good working order. She is not a show boat, but she's my pride, and I like to be ready to sail anywhere at any time.

So my budget for the boat, refits and cruising for the last eight years has come to a total of \$330,000. Broken down, that's \$175,000 for the boat and refits, \$90,000 in maintenance, gear replacements and haulouts, and \$65,000 in food and diesel. It does not include medical costs and that of plane tickets home to visit family. So my eight-year cruise has cost over \$41,000 a year. I expect that my boat is currently worth \$100,000 if I wanted to sell her. So if I sold my boat today, my cost would have been just under \$29,000 a year. I would be surprised if you can poke a stick in my figures, because as I said, I'm a budget cruiser all the way.

Since my last refit in 2007, I have spent average \$15,000 a year replacing gear failures. I'm now on my second refrigerator, second windlass, and third autopilot. In addition, I spend about \$6,000 a year for food and \$2,000 a year for diesel.

That said, I'm not complaining, and I'm happy with my life. Depending on how you want to calculate it, I spend either \$29,000 or \$41,000 a year to surf waves that others pay \$6,000 to surf for just 10 days. I've been getting to surf epic waves most of the year, and haven't worked a job in over five years. The latter is not by total choice on my part, as there have been legal and logistical issues. So while I'm not complaining, I think it's important that people know what it really costs to go cruising.

I understand that it's possible to cruise in parts of Mexico — and other places — for much less. I cruised Mexico for three years on a \$10,000 boat and spent another \$10,000 while I was there. But that was with a very basic boat that had 30-year-old sails, no windlass, no sounder, and just a handheld GPS, rowing dinghy and liferaft. But when you cross an ocean, you're in a different environment.

With regard to the guy who said he cruised the Med for \$700 a month, I would not want to be in a blow on his boat after five years of cruising, that's for sure. I bet the boat smells too. In fact, he might just be the guy anchored way away from the rest of us here in Phuket right now.

I love *Latitude*, that it's online, that you know your stuff, and that it's staffed by surfers.

Kevin Whitegon
Helena, Tayana 37
Phuket, Thailand

Kevin — Thanks for the kind words, although we have to admit that we're more SUP-ers these days than we are surfers. But we've still got the stoke — at least in 80-degree water.

You couldn't be more correct than when you say the cost of cruising is hard to pin down because of the variables. The main variables are usually the cost and condition of one's boat going in, how extensively the boat is equipped and the condition of the existing gear, how good a person is at maintaining and repairing stuff, and what part of the world one is cruising in and at what speed.

While it's vague concept, when most people talk about the 'cost of cruising', we think they are referring to the average



 **Interlux**®

Our World is Water

Protect your investment

There's a reason that InterProtect 2000E is the popular primer choice for all boat types. It works. Whether it's guarding the fiberglass against blistering or protecting the metal from corrosion, it works. Anywhere from keel to mast InterProtect 2000E is the long-lasting, trusted epoxy primer that gets the job done. All boats, whether old or new, need protection from the marine element, so choose InterProtect 2000E and invest in peace-of-mind and more time to go boating.

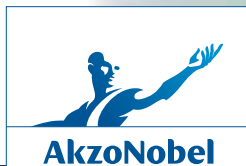

www.yachtpaint.com
www.facebook.com/InterluxPaints

SPAULDING WOODEN BOAT CENTER



The oldest boatyard in Sausalito!
AFFORDABLE QUALITY



By bringing your boat here to be repaired or restored, you will also be supporting, preserving, and celebrating the craftsmanship and traditions of wooden boat building.

Our crane has a 12 ton capacity.

We specialize in wooden boats and service fiberglass and metal too.

From haul outs to full restorations, we do it all!

**WE HAVE THE PERFECT PLACE FOR YOUR WINTER PROJECT
BOOK IT NOW!**



SPECIAL PROJECTS SPECIAL PRICES

ROSS SOMMER, MASTER SHIPWRIGHT

(415) 332-3179 or

boatworks@spauldingcenter.org

FOOT OF GATE FIVE RD. SAUSALITO, CA 94965

WWW.SPAULDINGCENTER.ORG

LETTERS

monthly expenses after they have the boat and have equipped her to take off. Calculated that way, your cost of cruising would be about \$24,000 a year, \$15,000 of it being for gear and maintenance. That strikes us as reasonable amount for a singlehander, but certainly not low-budget.

The thing that strikes us about your expenditures is that you seem to have paid a lot of money for a boat that you seemingly needed to rebuild immediately from not much more than a hull and mast. The engine was ancient, five bulkheads needed to be replaced, the chainplates were bad, she didn't have a dinghy or outboard, and she didn't have a windlass, SSB, refrigeration, roller furling, or self-tailing winches. With all due respect, it seems as though you paid \$55,000 for a monumental fixer-upper.

Had you had the \$175,000 you've ultimately spent on your boat, you could have bought the best Tayana 37 in the world, wouldn't have had to do any work on her, and would have had \$50,000 to \$75,000 left over. Few sailors appreciate the amount of time and money it takes to restore a fixer-upper. We suggest making one's very best estimate, then multiplying the time and money by four. Seriously. While it costs more money upfront, in the long run it's almost always less expensive to buy a boat that is already well equipped with relatively modern equipment.

The one thing almost all cruisers tell us is that they spend what they have. For example, Ben Doolittle of Sacramento just completed a two-year cruise from the Ha-Ha to Annapolis with his wife Molly and sons Mickey and RJ aboard the Catalina 38 Knee Deep. "While we probably spent an average of \$3,750 a month," Ben says, "there were months when we only had \$2,000 come in, and we lived on that. On months when we had \$6,000 come in, we somehow managed to spend all that, too. You spend what you have."

Well, not everybody does. Take Jake van Ommen of the Gig Harbor-based Nadja 29 Fleetwood. When he left Santa Barbara for Thailand in early 2006, he had \$200 to his name and the promise of \$1,700 a month from Social Security — nothing else. He's since cruised more than 40,000 miles to more than 40 countries. And while we're not sure if he's still doing it, for the first three or four years he, having once gone bankrupt, religiously put \$1,000 of the monthly \$1,700 in the bank each month. Somehow he was able to live on a total of \$700 a month, and he didn't feel deprived at all. By the way, he recently left Holland for Colombia, where he'll begin exploring South America.

The guy who spent \$700 a month while cruising in the Med a few years back was Mike Harker of the Manhattan Beach-based Hunter 466 Wanderlust. Mike was a quiet and meticulous guy who kept his boat clean as a whistle and all her systems in perfect running order. He'd just taken delivery of Wanderlust when he singlehanded her across to the Med. Although Mike owned a triplex on the water in Manhattan Beach, he was thrifty by nature. For example, he ate lots of Costco canned chicken because he wanted to, not because it was all that he could afford. He rarely stayed in marinas, and his only dining extravagance ashore was a cup of coffee each morning when he'd people-watch and do his socializing. Mike later took delivery of the new Hunter 49 Wanderer III, and singlehanded her around the world in 11 months.

While we think most cruising couples spend between \$25,000 and \$50,000 a year, there are certainly those who spend way over \$100,000 a year because they can, and those who spend under \$10,000 a year because that's all they have. Our friend Jim Green of Martha's Vineyard took off from Panama on the start of his third circumnavigation aboard his 10 Meter Tango II with \$150. "Don't worry," he told his new girlfriend,



Mazatlán, the only Colonial City on the Beach

marina  mazatlán

June 1st thru October 31st, 2014 - SUMMER MONTHS
(MUST STAY THE 5 MONTH PERIOD)

**24 CENTS
PER FOOT**
PLUS IVA (TAX)

40 FOOT BOAT = \$341 / MONTH INCL. IVA

50 FOOT BOAT = \$426 / MONTH INCL. IVA

60 FOOT BOAT = \$511 / MONTH INCL. IVA

**THE BEST
RATES IN
MEXICO!**

MAKE YOUR RESERVATION

NOW!

PHONE: 011-52-669-916-7799 FAX: 011-52-669-669-2937

EMAIL: atec@marina-mazatlan.com

VISIT OUR WEBSITE AT: www.marina-mazatlan.com



- NEW
- USED
- REFINANCE



Boat Loans Made Easy®



Let our 31 years of experience go to work for you!

Call
866-377-3948

www.essexcredit.com

EQUAL CREDIT OPPORTUNITY LENDER

Loan Amounts from \$25,000
Instant Loan Approvals* • 90 Days to First Payment*

*Subject to Loan Program Guidelines and Credit Approval
Reference Code = MAR931

LETTERS

"we'll find a wreck or something and make a little money." And they did.

In a July 2011 Sightings piece, Cindy Holmes and Faith Tamerin of the Berkeley-based Vanguard 32 Carmen Miranda stated, "The only way for women with no real money to see all the things they want to see in the world is by cruising boat. Two women can cruise the world on \$500 to \$600 a month." Mind you, they spent the last nine years of their circumnavigation in the Med, going up the canals of Europe — a berth in Paris was \$25/night — and over to Ipswich, England, where they used the boat as a very cheap hotel and restaurant for two years.

↑↓ LIVING AT POVERTY LEVEL AND LOVING IT

The publisher of *Latitude* asked us if we'd be willing to share what it's been costing us to cruise for the last 14 years. It seems to vary depending on the amount of money avail-



COURTESY SAILORS RUN

Debbie and Jeff Hartjoy may live at poverty level, but you'd never know it.

able to us. But the average for the last five years has been about \$1,500 per month. That's allowed both of us to fly home once a year to visit family and do basic maintenance on our Baba 40. In the five years prior to that, we got by on \$800 per month, which included basic maintenance, but only allowed one of us to fly home each year. We do have some investments that allow us to dump an additional \$5,000 into the boat every five years for new sails and rigging, as we need to keep *Sailors' Run* in top shape.

We're enjoying the America's Cup racing on the Bay, but can't wait for the start of what will be our third Ha-Ha.

Jeff & Debbie Hartjoy
Sailors' Run, Baba 40
Longbranch, WA

Readers — Just so nobody is mistaken, the Hartjoys don't just sit in an uninhabited anchorage in the Sea of Cortez and call it cruising. After doing their first Ha-Ha in 1999, they spent seven years sailing to and around the South Pacific. After doing their second Ha-Ha in 2006, they sailed down the west coast of South America, after which Jeff singlehanded around Cape Horn. Since then they've sailed up to the Caribbean, back to the Pacific, and up to California. These folks are so full of life, we can't wait to see them in San Diego at the start of this year's Ha-Ha.

It's people such as Jeff and Debbie — and there are many more — who are proof positive that it's possible to cruise very actively on a modest budget. We'll remind everyone that \$1,500 a month, which is \$18,000 a year, isn't much more than \$15,500, which is considered to be the poverty level for two in the 48 contiguous states. In Alaska, it's \$19,380, or more than what the Hartjoys spend to cruise.

↑↓ AVOIDING BEING FLEECE BY TAX ASSESSORS

I recently read the following blog at bit.ly/18HNr2X:

"California trying to fleece former property taxpayers. We'd sold the house and cars, and left nothing in California but a post office box. When we left our slip in San Pedro, we made sure the harbormaster signed us out as having departed.



Almar Marinas

Everywhere you'd like to be



Est. 1973

Now Available at
Oakland Marina
Ballena Isle Marina



Join one Almar Marina and enjoy reciprocal privileges at any of Almar's 16 locations from San Francisco to San Diego and out to Hawaii. Each marina provides programs and events that are included in your slip fees:

- *Boat Handling
- *Social Events
- *Electrical Courses
- *Anchor Outs
- *Seminars on Local Destinations

www.almar.com

855.SLIPS 4 U
855.754.7748



SOLBIAN SOLAR PANELS

15% OFF

Made from high efficiency SL or SunPower™ cells for the highest power available. Can be mounted on curved surfaces including directly to canvas.

Extremely light – only 2.35kg (about 1/8th the weight of a traditional solar panels).

Can be easily mounted/removed on your dodger or bimini with Velcro or zippers.

Panels supplied with short wires & plugs allowing easy connecting & disconnecting from the boat wiring. Svendsens also offers top of the line Genasun MPPT solar controllers providing the most efficient charging of your batteries. The system is easy to install.

— SP80L & SP100L IN STOCK —



“A new era of solar power.”
-Bruce Schwab



SALE ENDS 10/31/13. MAY NOT BE COMBINED W/ OTHER OFFERS.



**SVENDSEN'S
CHANDLERY**

Open 7 days a week!
Chandlery & Rig Shop / 510.521.8454
info@svendsens.com / www.svendsens.com
1851 Clement Avenue, in the Alameda Marina

LETTERS

Despite all this, we still got a personal property tax bill for our boat from Los Angeles County.

"When we called up the Assessor's Office to tell them that we were not in California at any time during 2013, they insisted that we show proof of *continuous* slip occupancy in Mexico. Say what?! When we pointed out that we spent many days out at sea and many days out at anchor, they couldn't grasp the concept, and still insisted that we had to show receipts. Then they insisted that the Coast Guard records showed us still being in Los Angeles because our boat's hailing port is Los Angeles. Somehow the onus is on us to show proof that we were not in California rather than them showing that we were.

"Yes, you could say that we are livid. We assume they will try the same stunt next year. I used to feel good about our paying taxes, but now I wish we'd tried to shirk them as we're assumed to be doing anyway. Idiots!"

A friend of mine wrote the blog, not I. But as I will be leaving Los Angeles myself to go cruising in a couple of years, I want to know what I can do to prevent being caught in the same situation. What can a sailor do to ensure that the county is legally obligated to release a boat from their tax rolls? Is this a common problem for California boats going abroad?

I can't help but wonder if somebody in the County Assessor's Office is making things up. Are there other counties in the state that require a boater to provide proof of continual slip occupation in Mexico to release the boat from the county tax rolls?

Mike Crews
Valinor, Ericson 32-300
San Pedro

Mike — Assessors in the various counties of California interpret the personal property tax laws differently. Some counties don't require any proof that you've left the county with your boat, while others demand to see extensive proof. We don't have statistics to back it up, but our understanding is that Los Angeles County is one of the most demanding and least understanding counties.

There are two solutions. The first is to contact your County Assessor and ask what the county's policy is. The downside of this is that such policies are subject to change when counties need money badly — which is, more and more, all the time. A permanent solution, one favored by many cruisers, is to sever all ties with the county and the state of California by taking up residence, so to speak, via a mail forwarding service in a more tax-friendly and understanding state.

One such service popular with cruisers, full-time RV travelers, merchant seamen, traveling nurses and such is St. Brendan's Isle Mail Forwarding in Green Cove Springs, Florida. As the company website states, "For many of our more than 4,000 clients, Florida is an ideal state to establish residency and register vehicles. Florida has no state income tax, and tag registration is very economical. As part of our mail forwarding services, we can provide the necessary forms and instructions for these important administrative matters. In addition, we can provide assistance with these other administrative matters such as Florida voter registration, Florida driver's license, renewal of Coast Guard vessel documentation and more."

Once you dump your California post office box and can demonstrate to your former county and the state that you're registered to vote in another state, have a drivers license in another state, and get all your credit card and other bills in another state, it's easy to get them off your back. The important thing is to work with a mail forwarding agency that provides



Cruising Mexico Seminars

**Hosted by
Dick Markie,**

**Paradise Village Marina Harbor Master &
Geronimo Cevallos,
Marina El Cid Harbor Master**



SEMINARS AT:

Puddle Jump at Downwind Marine San Diego
Wed., October 23, 6:00 p.m.

Cruising Mexico at West Marine San Diego
Fri., October 25, 4:00 p.m.

PROGRAM

Safety

Timing

Route

Weather

Events

Provisioning

Paper work

Fishing

Health Care

Navigation

No Charge - Mexican Prizes - All questions about Mexico will be answered!!!

marina@paradisevillagegroup.com / Tel. 011 52 322 226 6728 / www.paradisevillage.com

gcevallos@elcid.com.mx / Tel. 011 52 669 916 3468 / www.elcidmarinas.com



**West Marine®
Rigging Service**

Your Sailing Resource!

- Specialty Hardware
- Technical Apparel



Visit westmarine.com to shop our
New One Design offerings

Your Complete Rigging Source!
Installation • Lifelines • Running Rigging
Standing Rigging • Dock & Anchor Lines

Mobile Rigging Service Available

**SCHAEFER
MARINE**

FSE ROBLINE
WORLD CLASS YACHTING ROPES

RONSTAN

POWERLITE
RIGGING

Johnson
Marine Hardware

NEW ENGLAND ROPES
TOGETHER IN MOTION

SAMSON

facnor
FURLING SYSTEMS

Hayn Marine

LEWMAR

SmartRigging
The Intelligent Choice

HARKEN

FORESPAR

SmartRigging
The Intelligent Choice

HARKEN

Contact us for all of your Rigging Needs!

888-447-RIGG (7444)

or visit our Onsite Rigging Locations in:

Alameda, CA San Diego, CA Seattle, WA

730 Buena Vista Ave. 1250 Rosecrans St. 1275 Westlake Ave. N
(510) 521-4865 (619) 255-8844 (206) 926-0361

www.westmarine.com/rigging

LETTERS

you with a street address, because if California just sees a P.O. box number in another state, they are going to consider it bogus. The typical mail service for cruisers costs about \$14 a month, and you should check their website for all the many benefits. There are other mail forwarding companies in other tax-friendly states that offer similar services, so you may want to do a little comparison shopping.

By the way the motto of the L.A. County Tax Assessor is 'Valuing People and Property'. What a joke, as a more accurate motto would be 'Corruption Is Us'. For example, on October 17, 2012, Los Angeles County Tax Assessor John Noguez, the head honcho, a Mexican-American whose birth name was Juan Renaldo Rodriguez but who has



LA TIMES

L.A. taxpayers can rest easy knowing their tax assessor 'values people and property'.

also used the aliases Juan R. Noguez, John R. Noguez, and Juan Reynaldo Rodriguez Noguez, was arrested on 44 counts of conspiracy, bribery and corruption. Bail was set at \$1.36 million. Key conspirators Mark McNeil, Noguez's chief appraiser, and Ramin Salari, a campaign

contributor, old friend, and Arizona tax consultant, also were arrested. Between February and September 2010, Noguez allegedly accepted \$185,000 in bribes from Salari and used his influence to greatly lower the appraised property values for Salari's clients, saving them millions of dollars in property taxes.

During a warranted search of Noguez's Huntington Park home — he had previously been mayor — investigators purportedly found a list of about 20 of Salari's clients seeking significant reductions in their property assessments. Almost all of the requests were honored. Among the properties to receive illegal tax cuts were those owned by Douglas Emmett Inc., whose chief executive, Jordan Kaplan, and wife were — and this will come as a real surprise — Noguez's top campaign contributors. In Noguez's first year in office, 23 tax reductions were granted to Douglas Emmett Inc. For instance, Kaplan's \$21.5 million home in Pacific Palisades received a tax break of \$198,000. Most other big tax cuts went to — big surprise again — other high-end properties on the affluent Westside.

Noguez, who is still married to Lilliana Guerrero, a woman who is openly gay — not that there's anything wrong with it — spent from October to March in an isolation cell in the Los Angeles County Jail waiting to raise \$1.6 million in bail. Most of it came from a single individual. Noguez is on a leave of absence, which means he still collects his salary of \$197,000 a year while facing as much as 30 years in prison.

Had the author of the blog made a significant enough 'campaign contribution' to Noguez, we doubt the Assessor's office would have bothered him.

How to get rid of corruption in California? 1) Because they are 'public servants', all government officials and employees accused of crimes against and/or abuses of taxpayers should be presumed guilty, not innocent, until they prove themselves innocent. If they are clean, it should be easy enough for them to do. 2) Erect guillotines in front of every city hall. 3) Use the guillotines. Corruption is the cancer of the world and must be stopped.

↑↓ OAKLAND'S ANCHOR-OUT COMMUNITY

The editors of *Latitude 38* have more or less gone on re-

Access Channel
Just Dredged

In The Center of San Francisco Bay

Perfect Location - Great Investment!

EMERY COVE
YACHT HARBOR

BUY OR RENT A SLIP

- BUY A SLIP - Save money and earn equity! Enjoy tax savings. Listings start at \$39,500. Emery Cove Yacht Harbor is the only marina on the Bay with FEE SIMPLE (not a grounds lease) dockminium ownership.
- RENT A SLIP - 35-60' slips, rates from \$9.50 to \$10.50 per foot.

AMENITIES

- Free Wireless Internet, Modern Facilities and Marina Guard® ground fault monitoring.

ON PREMISES

- CharterSF • Emeryville Yacht Club • Mathiesen Marine
- Michael Wiest Yacht Sales • SailTime
- Seaward Coastal Ventures



CALL FOR AN INFORMATION PACKET | 510-428-0505

3300 Powell Street, Emeryville, CA 94608 | www.emerycove.com | Email: info@emerycove.com

Michael Wiest Yacht Sales

QUALITY SAILING YACHTS



Scan with your smart phone
for a list of our yachts.

Three convenient San Francisco Bay Locations!

3300 Powell St, Emeryville (510) 601-5010

25 Third St, San Rafael (415) 453-4770

400 Sierra Pt Pkwy, Brisbane (650) 589-8990

www.mwiest.com



47' BENETEAU 473 \$239,000
(510) 917-7749 • Michael



45' JEANNEAU DS \$299,000
(415) 290-1347 • Mark



49' JEANNEAU DS \$299,000
(415) 290-1347 • Mark



38' HANS CHRISTIAN \$99,600
(510) 410-5401 • Bill



44' MOODY \$179,000
(510) 917-7749 • Michael

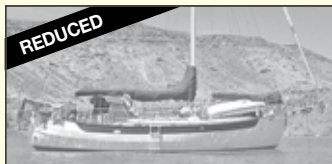

38' HANS CHRISTIAN \$99,000
(415) 290-1347 • Mark



36' ISLANDER FREEPORT \$64,000
(510) 410-5401 • Bill



BENETEAU FIRST 36.7 \$124,000
(415) 290-1347 • Mark



35' BABA \$59,000
(415) 290-1347 • Mark



38' CARRERA \$64,000
(415) 290-1347 • Mark

43' FRANZ MAAS KETCH\$129,000
40' X-YACHTS X-402, 1986.....\$175,000
35' RAFIKI \$48,500
32' WESTSAIL, San Rafael..... \$37,000

Outboard Engine Owners:

WE UNDERSTAND



When an engine dies, there's no walking home – just costly repairs, lost vacation time, and lost revenues.

Don't find yourself in this boat. Regular maintenance prevents expensive repairs.

We are *your* experts for outboard diagnostics, repair, repower, sales and service.



- Factory-trained and certified techs
- Open six days a week
- New and used engines bought and sold
- One-year warranty on all work performed and used engine sales
- Three-year warranty on all new engines

MARINE OUTBOARD

since 1990

OUTBOARD SALES, SERVICE, REPAIR, PARTS

(415) 332-8020

Nissan
Tohatsu
Johnson
Evinrude



Honda
Mariner
Mercury
Yamaha

35 Libertyship Way • Sausalito, CA 94965

Conveniently located at Libertyship Marina

If we're not maintaining your outboard, you've missed the boat!

LETTERS

cord in favor of rousting Oakland's boat community — the liveaboards who have anchored their boats in the Oakland Estuary near Union Park. The fact that it seems the editors — from what they have to say about Oakland — wouldn't set foot here hasn't stopped them from condemning the liveaboards as a bunch of thieves or whatever.

Being a long-time resident of Oakland, and one who enjoys all the down-to-earth people who live around me, I actually



JOHN REIMANN

Oakland's 'flavorful' anchor-out community.

took the time to go out and interview one of the people who live in that community. Below is a link to the interview I did. Maybe at least those with a sense of humanity who look at it will come away with the understanding that these are real live human beings, not just some label like 'thief', whose lives will be turned upside down if they are kicked out of here.

The video can be seen at: oaklandsocialist.com/2013/09/13/oaklands-boating-community.

John Reimann
Y-Knot, Catalina 36
Oakland

John — It's nice of you to tell us what we believe, "more or less," but thanks, we can speak for ourselves. And more precisely, too. 1) We believe in anchoring out and living aboard where appropriate. We do it all the time in California and Mexico, and all over the Caribbean. A long time ago, Oracle's Larry Ellison was so poor he lived aboard a sailboat in the Berkeley Marina — until he had to sell his boat to be able to buy food. 2) We agree with laws requiring boats to be registered with the state or documented. 3) We agree with laws requiring boatowners to follow prescribed safety requirements for their boats and that the vessels should be navigable. 4) We agree with laws requiring boatowners to have their boats comply with environmental regulations. 5) We believe that there has historically been a strong correlation in California and other places between authorities' not enforcing 2, 3 and 4, and surrounding communities becoming hotbeds of crime. Can we make it any clearer than that?

We went to the Oakland/East Bay Socialist Group website you suggested and watched the video interview with Mike West. We urge Latitude readers to do the same. It was Mr. West, the gentleman who was being interviewed, not us, who said, "One of the biggest problems is that there is a lot of theft that goes on out here [Union Park area] and in the marinas." He mentioned that there was an organized group of people who steal outboard motors, and that he ran into a guy in Tahoe who had 10 nice outboards in the back of his van, for sale, cash only. West also said that some of the residents of the community have to "scrape or steal" for a living. And that some previously sold pot. "That's what I did," West says. "Mostly in the carnival business. That's the one job I've gone back to. Like a good carnie, I spent all my money cruising the world."

Based on the video, West looks like a nice guy. If he adhered to 1, 3 and 4 above, and didn't steal our stuff, it would probably be fun sharing an anchorage with him. Although we'd ask him

RARE OPPORTUNITY!

Two 40' Covered Slips, a 62' Slip & a 96' End Tie Available

LOCH LOMOND MARINA

Completely Rebuilt Marina • Gas & Diesel Fuel Dock • Free Pump Out Station
Modern Launch Ramp • Guest Slips Available • Marine Mechanical Boat Repair
Arena Marine Supply Store • Andy's Local Market • Bait Shop
Land or Sea Canvas • Windjammer Yacht Sales • Loch Lomond Yacht Club

110 Loch Lomond Drive, San Rafael, CA 94901

Phone: (415) 454-7228 • Fax: (415) 454-6154

www.lochlomondmarina.com

Harbor Master – Pat Lopez • pat@lochlomondmarina.com

SAUSALITO



LIST MARINE INC.

- Full service engine shop
- We service all makes
- Dockside facilities
- Mobile service trucks

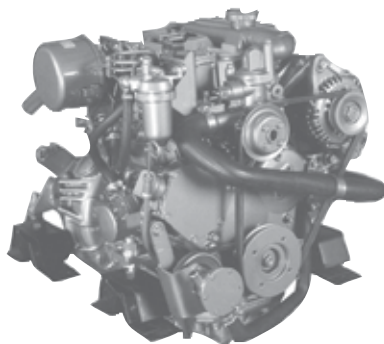

YANMAR
marine 

P.O. BOX 2008 / 69 LIBERTY SHIP WAY • SAUSALITO, CA 94966
Adjacent to Schoonmaker Pt. Marina

415•332•5478

www.listmarine.com



53 years of worldwide service ~ Shipping to every ocean

- Expert staff
- Used hardware
- Special Orders
- Lowest Prices for new items
- Service loft, modifications, cleaning and repairs

SAILS ♦ SHIP STORE ♦ CONSIGNMENT

*Brand New Coastal Cruising Sails For All Boats –
SUPER LOW PRICES*

(410) 263-4880

www.BaconSails.com

116 Legion Ave., Annapolis, MD 21401

WYLIECAT 40



Safe, fun, fast.
Race, cruise, or charter.



bearmark YACHTS

BROKERAGE BOATS

Garden-Calkins Schooner	68	1965
Wyliecat SRV <i>Derek M. Baylis</i>	65	2004
Skookum CC Ketch	47	1972
Jeanneau DS	42	2008
Wyliecat	40	2014
Wylie	39	1985
Rafiki Cutter	37	1977
1D35, one design	35	2000
Hanse 350	35	2008
Sea Ray Sundancer	34	2001
Bristol 31.1	31	1983
Wyliecat	30	1998
Wyliecat (1/2 share)	30	2001
Herreshoff Ketch, a "10"	30	1962
Bertram, with trailer	25	1969
Osprey Pilothouse	24	2002

Welcome our new Southern California regional agents: **HELEN KAZ** and **CAPT. BOB CITELLI**

310 Harbor Drive, 2nd Floor, Sausalito, CA
415/332/6585

Larry R. Mayne, broker B-02871
John Saul, bearmarkyachts@gmail.com

LETTERS

to please not smoke when he came onto our boat.

According to West, the State Lands Commission notified anchor-outs near Union Park that they are trespassing, and are subject to arrest as of September 27. West predicted that the Alameda County Sheriff would take everyone off their boats, declare the boats abandoned, then charge the owners for towing and storing their boats. "Big Brother plus," he calls it.

Your contention is that the anchor-outs are getting kicked out because the "big real estate interests that run Oakland," in conjunction with the Chinese, want to develop the 'Oakland Riviera'. You're probably right. Personally speaking, we think development and gentrification of Oakland are the only things that have a chance of actually helping the truly needy get the assistance they need. Poor people stealing mostly from other poor people is an inefficient and unsustainable economic model.

↑↓ THE CASE FOR CELESTIAL NAVIGATION

I've recently returned from an offshore passagemaking class, where I had my students practice celestial navigation skills they'd learned earlier in the year. It's one thing to learn in a classroom with some dockside practice taking and reducing sights, and an entirely different experience applying celestial navigation on a small boat in challenging seas.

My students often ask me: "Why do I need to know celestial navigation when GPS units are so readily available and economical?" I respond by telling my story of navigating in the 1992 Pacific Cup race to Hawaii. Just for the fun of it, I was practicing my celestial navigation every day. I guess I was a bit of a pest, asking people to take notes for me, to record times, and even to move so I could get a better view of the sky. Four days into our trip, the skipper dropped his only GPS unit. It was the early days of GPS, so the units were quite pricey, and most boats didn't have three or four as they do today — and the batteries came out. We took out the manual, but after several hours we still couldn't get the GPS to work. As a result, I was instantly promoted from Pest to Assistant Navigator, and no one complained again about my carrying on with celestial navigation.

I used a sextant to navigate in the '94 running of the Pacific Cup, and won t'the West Marine/Henry Lloyd Pacific Cup Navigator's Trophy.

There are many scenarios in which GPS just might not be available. Yes, some of those scenarios are unlikely, but if you were making an ocean passage, wouldn't you like to have a back-up method of navigation?

A fellow sailor has told me that using celestial navigation is like relying on a Model T for transportation. He may be right, but I personally take great joy in being able to maintain an old vehicle without having to pay someone else to do it. Unfortunately, when I look under the hood of a new automobile these days, it is pretty clear that for any major problems, it's going to have to go to the mechanic or electronic technician. It's the self-reliant part of doing things that has always been attractive to me, and isn't sailing a sport where self-reliance is key? After all, if we are merely interested in getting from Point A to Point B, there are many more efficient means of transportation.

In the offshore passagemaking class, it was fun to see the delight in my students' eyes when their celestial observations agreed with our recorded DR and GPS positions. Even though we had 10 or more GPS units aboard our vessel, it was the celestial navigation that proved to be the most fun way to navigate.

Captain Craig Walker
Lead Instructor, Tradewinds Sailing School
San Francisco

Think Fast!

Fast boats made to order...



Berkeley Marine Center

The yard that works for you!

In Berkeley Marina
510-843-8195

www.berkeleymarine.com

SAL'S SOUTHBOUND CHECKLIST



Be prepared **BEFORE** you head south!

HYPALON TENDER

LIFERAFT

EPIRB

REPAIR KIT

Extended!
\$100
ACR Rebate
expires
11/5/13

SALES
SERVICE RENTALS

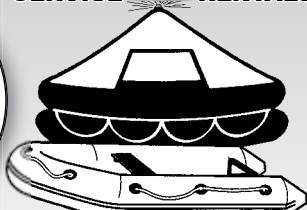

PHONE (510) 522-1824 FAX (510) 522-1064

1914 Stanford Street, Alameda, CA 94501
salsinflatables@sbcglobal.net • www.salsinflatablestudies.com

Defender®

Marine Outfitter of Choice Since 1938

THE BRANDS YOU WANT AND TRUST IN STOCK FOR LESS!



Series 34 LED Tri-Color / Anchor Navigation Light

- Masthead or deck mount, tri-color LED navigation light
- Operating Voltage: 12 Volt DC
- Draw: 0.18 - 0.54 Amp @ 12 Volt DC
- Visibility: 2 NM
- Dimensions: 3.50" OD x 5.50" H
- Available in white or black housing

Item 701384 **Only \$286.99**

Visit us at the Annapolis Boat Show • October 10-14, 2013

defender.com ★ 800-628-8225



FREE Catalog! Most orders placed by 4:30PM ET ship the same day!
We are not required to collect sales tax on orders shipped outside of CT!

America's Cup is over - now it's YOUR TURN!



You can skipper this sized boat,
after just 8 days!

Package Value

\$2,820

ONLY

\$1195

Package Includes:

- Basic Keelboat Course
- Basic Cruising Course
- Bay Cruising Workshop
- 1 Year US Sailing Membership
- Club Nautique Membership Initiation*
- All Course Materials
- US Sailing Certification to skipper boats up to 34'
- Classes in Alameda or Sausalito

Offer expires 10/31/2013

* One Year Membership contract required

Call Today!

Sausalito 800-559-CLUB
Alameda 800-343-SAIL

**Club
Nautique**

You're at the helm!

www.clubnautique.net

LETTERS

Capt. Craig — We admire those who are into the Zen of celestial, but even when making passages we just don't have that kind of time. That's why, no matter if we're offshore in the Caribbean or doing a Baja Bash, we navigate by iPad.

↑↓ CELESTIAL NAVIGATION AND TIMEKEEPING

I'm hoping that someone can point me in the right direction, as I'm trying to learn basic celestial navigation for its own sake, and in case I ever get to sail farther offshore than Catalina.

I think the School of Sailing & Seamanship at Orange Coast College in Newport Beach has a good in-depth celestial navigation course, but it's too far away for me to attend. Are there any other in-depth study programs or classes in San Diego that would help me grasp celestial faster than I'm currently doing by reading books?

The main reason I've heard for navigating with celestial in tandem with GPS is in case your boat is struck by lightning and your GPS turns to goo. But I think there is another reason, as doing celestial would require that I maintain good time-keeping. Most affordable chronometers are digital, and would suffer the same fate as the GPS in the case of lightning. So I'm wondering if I could keep a second digital chronometer in a Faraday cage (steel box) and expect it to survive a lightning strike. Is my only foolproof option to purchase, for thousands of dollars, a mechanical chronometer such as an Omega or Rolex? Is there a modern mechanical ship's chronometer made by anyone for this purpose?

David Lovato
Tardis, Catalina 27
San Diego

David — Historically, the fastest way to learn celestial is by setting sail with a sextant, a timepiece, an instruction book, and the necessary tables. Once sailors get lost, they tend to be better able to focus on the process of learning celestial.

From time to time the Maritime Museum in San Diego gives a 12-week course in celestial navigation, which includes a sail aboard the tall ship Californian to hone those skills at sea. This year's course ended in June, but they'll probably be giving another one soon. It's a rather long course that includes a lot of history, so you might ask around for more bare-bones instruction.

It's possible that a lightning strike could wipe out a GPS — as well as all your other electronics. But if you have the GPS units spread around the boat — on Profligate we have one in each nav station, one above the owner's bunk, and navigation apps in both our iPhone and iPad — it would be pretty hard for lightning to knock them all out. If we get in a lot of lightning, we might wrap a couple in foil and put them in different places around the boat. We're confident that at least a couple of them would still work.

Naturally all six of our GPS units come with very accurate clocks, as does our VHF radio. So we'd only get a Rolex or Omega to impress a woman.

↑↓ HURRICANE AVOIDANCE SOUTH OF THE BORDER

Please cover Hurricane *Ingrid* and Tropical Storm *Manuel* in depth. I've been doing detailed charting of both the Pacific and Caribbean sides of Mexico and Central America for an upcoming trip next year. Once you head south of the Sea of Cortez, and especially south of Mexico, there are relatively few ports on either the Pacific or the Caribbean side and even fewer marinas, and many of the 'ports' in the chart books are simply a long pier for piping fuel or where local fishermen pull their boats ashore.

COME VISIT COYOTE POINT MARINA

The Peninsula's Complete Recreational Destination!



BERTHING

- Slips to 40' available
- Inside ties from \$100 per mo.
- Multihull side ties available
- Check out our rates!

FUEL DOCK & PUMP OUT

- Open 7 days per week
- Gas and diesel available
- Check our prices
- Free pump outs

**Fuel Dock
currently closed
for repairs.**

COYOTE POINT MARINA ~ 1900 Coyote Point Drive • San Mateo

650.573.2594

Custom Canvas & Interiors



The Gianola Family has been designing and fabricating custom canvas and interiors since 1969. Gianola Canvas Products offers you the best in quality, more choices, and personal service.



265-B Gate 5 Road
Sausalito, CA 94965
(415) 332-3339
www.gianolacanvas.com

THIS YACHT MAINTAINED BY:

Stem To Stern

FOR ALL CONCERNS, PLEASE CALL:

(510) 681-3831

Responsibilities of the

In-port Captain

Yacht Security • Cruise Preparation
Maintenance Scheduling • Delivery Services

- | | | |
|---------------------|--------------|-------------|
| • Hull Cleaning | • Brightwork | • Pump-Out |
| • Washdowns | • Mechanical | • Boat Yard |
| • Interior Cleaning | Service | Set-up and |
| • Detailing | and Repair | Management |

Check out our website for a list of all our services at

www.StemtoSternSF.com

or call (510) 681-3831

We Take the Work Out of Owning a Boat

Gori propeller

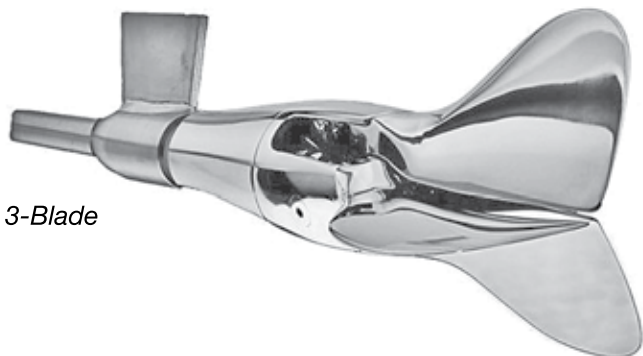

3-Blade

- For shafts and saildrives
- Both 2 & 3 blade available
- Lowest drag when sailing
- The champions choice



747 Aquidneck Ave.
Middletown, RI 02842

401-847-7960

Fax: 401-849-0631

sales@ab-marine.com

www.ab-marine.com

CALL US TODAY!

800-801-8922

LETTERS

Not ports in the U.S. expectation sense of the word.

There are some coves in Mexico, Guatemala and Honduras, and many coves in Costa Rica that I'd anchor in if the seas were flat, but the idea of picking one from the chart book or even my Google Earth snapshots, with pending hurricane landfall, sounds rather unwise. Having only ridden out one hurricane in Key West back in '86 — and it turned out to be a dud — I am inclined to say head for deep water far from shore. But I'd like to hear what your instinct says before the fact, then in hindsight as the news comes in, about how people actually fared.

By the way, in cases like this, it would be great if sailing sites had a 'Breaking News' area so people could get an idea how their cruising friends are doing.

John Wiesendanger
Pillar of Autumn, Hunter 40
Eureka

John — There's a one word answer to your last suggestion: Facebook.

It's unclear to us why you, a mariner, are making such a big deal out of Hurricane Ingrid and Tropical Storm Manuel. Ingrid was a mild Category 1 hurricane that started and ended in the Gulf of Mexico, where few cruising boats ever go. Manuel was a mere tropical storm that started at the latitude of the border with Guatemala, then made landfall near Manzanillo. While Manuel reformed to the northwest of Cabo, and temporarily had forecasters predicting a landfall at La Paz, it went 180 degrees in the other direction and dissipated over the mainland. The only cruising boats that might have been affected, and we doubt it, were at Grand Marina in Navidad, which offers excellent protection.

The big danger and destruction from both Ingrid and Manuel came from Biblical amounts of rainfall and resultant flooding. Manuel was forecast to bring 15 inches of rain in most areas, and 25 inches in others. Ingrid about the same. Landslides from each storm killed at least 20 people and many more are missing. Such landslides are as much a fact of life in those parts of Mexico as earthquakes are in California.

For the record, so far this season the Eastern Pacific, mostly meaning Mexico, has already seen nine tropical storms and six hurricanes. This is about average, and there'll be more before the season is over.

Avoiding tropical storms in Mexico isn't that difficult for mariners. Most boatowners simply take their boats out of Mexico or secure them in relatively well protected marinas at places such as Barra, Puerto Vallarta, Mazatlan, Cabo, La Paz, Puerto Escondido or Guaymas. Barra was hit by a tropical storm a few years ago, but the boats in the marina and the canals did fine. Vallarta, thanks to tall mountains and a turn in the coast, has never been hit by a hurricane. Mazatlan hasn't been hit in years. Cabo and La Paz get hit every couple of years, but usually not directly enough to cause severe damage. The boats at the marina in Cabo have withstood a couple of 100-knot direct hits. Puerto Escondido and Guaymas get whacked from time to time, even though they are far to the north, and some untended boats have been destroyed.

Tropical storms and hurricanes are extreme weather events that mariners should avoid at all costs. Nonetheless, it's not too hard to figure the odds of getting hit in the places mentioned, and it's low enough that you can get insurance for your boat in all of them during hurricane season.

If you're going to be cruising on the Pacific Coast of Central America, avoiding tropical storms and hurricanes is easy. They are virtually nonexistent in the winter, which is basically from

SHAFT SHARK

*The best rope,
line and debris
cutter there is!*

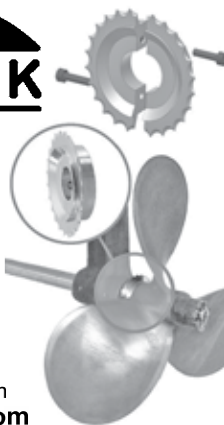

401-847-7960

sales@ab-marine.com

www.ab-marine.com

USCG
APPROVED
2NM LIGHTS

Navisafe Navi Light 360°

Dinghy & Emergency Lighting from Navisafe



The new Navi Light 360° is a cost-effective, super bright LED light that is visible in darkness from up to 5nm. Its high burn time, small size, waterproof qualities and ability to float make it a convenient and cost-effective addition to any cruiser's arsenal!



401-847-7960

sales@ab-marine.com

www.ab-marine.com

Yachtfinders/Windseakers

in the heart of
San Diego's boating community



IN-THE-WATER
BOAT SHOW
AT OUR DOCKS
NOV. 2-3



2330 Shelter Island Dr. # 207, San Diego, CA 92106
info@yachtfinders.biz
www.yachtfinders.biz
(619) 224-2349
Toll Free (866) 341-6189



48' MARINER MAYFLOWER, '81 \$134,900
Center cockpit ketch. These owners have made upgrades so that you can cruise the blue waters in comfort and security.



46' KELLY/PETERSON CC, '85 \$165,000
With the forefoot and keel/rudder areas cut away for responsive maneuvering, she tracks well. Short overhangs are safe in high seas.



44' NAUTOR SWAN 441, '79 \$79,000
A very high-quality boat with excellent engineering. *Avril* does have some deferred maintenance, which is reflected in the price.



42' CATALINA MKII, '07 \$199,000
One of the latest to be built, she has benefited from the evolution of the design and represents this well-loved model at its finest.



41' ISLANDER FREEPORT, '76 \$69,000
CC ketch. Lots of room and a flexible sail plan make this 'Classic Plastic' very family friendly. Large windows, clipper bow and bowsprit.



38' C&C Mk III, '86 \$69,500
Over \$40,000 in upgrades and improvements. Change in personal circumstances forces the sale of this magnificent vessel.



36' CATALINA, '84 \$37,000
Great sailing vessels with exceptional room and comforts. Join the Catalina family aboard this excellent example of Catalina quality.



36' MARINER, '80 \$48,900
The current owners have relished sailing her for more than 18 years and are confident that the new owner will share in their delight.



35' NIAGARA, '85 \$59,000
Abagwit spent the first 15 years of her life in fresh water, and as a result, has aged gracefully. A classic Mark Ellis accommodation plan.



34' HUNTER 340, '98 \$59,900
Named *Cruising World's* 'Best Value Midsize Cruiser' in its 1988 Boat of the Year contest. Spacious below and above decks.



34' CAL Mk III, '78 \$24,900
In production for 21 years and the most popular Cal model ever built. The owners take pride in her care and upkeep, and it shows.



28' BRISTOL CHANNEL CUTTER, '77 \$89,000
This Lyle Hess design and Samuel L. Morse build is among the most admired boats in the world. \$10,000 price reduction!

License #OE32738

TWIN RIVERS

MARINE INSURANCE
AGENCY, INC.

"Your Boat Insurance Specialists"

7 Marina Plaza • Antioch, CA 94509

At The Antioch Marina

38° 1' N 121° 49' W • Buoy 4 Red - On the San Joaquin River

Private Pleasure / Commercial Risks
Classic Yacht Programs



- West Coast
- Atlantic
- Mexico
- Hawaii
- East Coast
- Pacific
- Caribbean
- Alaska

Representing...



Shop Your Renewal & Save • Flexible Survey Requirements

Insurance made simple, affordable and effective.

Broad Navigational Areas • Liveboards

Years of unbeatable experience to match your needs to the right product.

Agreed Value Policies • Fuel Spill Liability

Get an online quote: www.BoatInsuranceOnly.com
(800) 259-5701

frigoboat®

KEEL COOLER SYSTEM

- No Pump
- No Fan
- No Noise

Arguably the world's most efficient, dependable refrigeration. The keel cooler and super efficient compressor make for a quiet, highly efficient 12V refrigeration system.



More than 12,000 Keel Cooler systems sold in the last 10 years. Designed for hot, tropical conditions.

Dealer Inquiries Welcome



SWEDISH MARINE

1150 BRICKYARD COVE RD., SUITE B6
PT. RICHMOND, CA 94801 (510) 234-9566

Suncoast Yachts

Exclusive California Dealer for

ISLAND PACKET & BLUE JACKET YACHTS



**California Debut
Long Beach Boat Show
October 24-27, 2013**

2330 Shelter Island Drive, #105
San Diego, CA 92106 • (619) 523-8000
www.suncoastyachts.com

MEXICO CRUISERS STEP ONE:

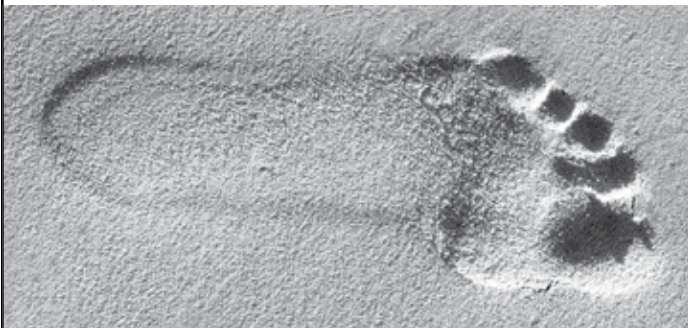

**MAKE A RESERVATION AT MARINA EL CID
FIVE STARS FULL SERVICE MARINA
MAZATLAN**

*You'll get such a great "impression"
from our marina services and beaches,
you may never leave!*



www.elcidmarinas.com
011-52 (669) 916-3468
marinaelcidmazatlan@elcid.com.mx

LETTERS

early November through May 15. From May 16 through October, stay either north of Turtle Bay or south of Guatemala. Costa Rica almost never has tropical storms. We think they got their first one in history last year, while Panama never gets them. If you want to be on the east coast of Central America during the hurricane season, you either stay in Panama or go up the Rio Dulce in Guatemala.

That said, we assume you know that the only time you have tropical storms and hurricanes is when it's very hot and humid, which is why most cruisers either take their boats out of hurricane zones or secure them and head to more pleasant weather.

Head for deep water if a tropical storm or hurricane threatens? Not us. Even tropical storms are worthy of fear and great respect. Boats are easier to replace than lives.

If it's any comfort, there are tens of thousands of people who have cruised from California to Mexico and Central America, and Panama to Cuba. The anchorages and ports of refuge are sufficient and known to everyone, as is the part of the year when you need to be particularly aware of possible major weather events.

⇅ **SUPERYACHT REGATTA WAS A SUPER DUD REGATTA**

I wonder if the America's Superyacht Regatta races are on video, and if so, where. I had difficulty finding the start times on the America's Cup website, so I contacted Hillary, the logistics person. She said the times "should be on the website." I know they should be, but I couldn't find them.

I saw some of these behemoths as I crossed the Bay Bridge on September 9, but couldn't get the info on the start times until it was too late. I wanted to see the clouds of sail these guys put up, and watch them race around the Bay. I suppose others would have liked to do the same.

Norm Allendorph
Yipe Yipe, Frers 40
Tiburon

Norm — Let's face it, the Superyacht Regatta was a super bust. The organizers didn't attract enough boats, maybe because San Francisco is so far from the waters of the Caribbean and Med where these boats like to play, maybe because San Francisco lacks the facilities to accommodate them, or maybe because the America's Cup folks wanted so much money from participants. It didn't help that the regatta organizers didn't provide timely information before or after the alleged event. Bummer. The accompanying photo shows what it should have looked like.

RICARDO PINTO / ACEA



We maybe be spoiled by Caribbean superyacht regattas, but the America's Cup Superyacht Regatta was just 'meh'.

⇅ **NEVER FORGET**

Thanks for elaborating on Cambodia's "troubled past," as Andrey Mantula — who was promoting Cambodia's first yacht marina — so blithely put it. How could anyone forget the ultra-vivid images of the Killing Fields?

Greg Dorland
Escapade, Catana 52
Lake Tahoe

⇅ **IMPOSSIBLE DREAM SAILS ON**

I read with great interest the reference to the Morgan 40



VALLEJO MARINA



Gateway to the Bay & Delta

The North Bay's Only Full-Service Marina!



- Slips starting at \$6.79 per foot!
- Concrete and wood docks
- Covered berths available
- Night security guard

(707) 648-4370 • Fax (707) 648-4660

42 Harbor Way • Vallejo, CA 94590

www.ci.vallejo.ca.us marina@ci.vallejo.ca.us



Check out our "Must-See" website!!

The Iverson's Dodger is now available in the Bay Area!

Dodgers • Bimini Tops • Enclosures



206-849-2274

www.iversonsdesign.com

SAN DIEGO'S RIGGING CENTER

Official Sponsor
2013
BAJA
HA-HA

since 1983



Proudly serving for over 25 years

Safe, cost effective, professional rigging solutions.

We'll get you ready for your next sailing adventure!

Design consulting • Commissioning
Refits • Custom line and hardware

WE SHIP RIGGING WORLDWIDE

2805 Cañon St., San Diego CA 92106

619.226.1252

www.pacificoffshorerigging.com



**Marine Mechanical Repair
Electrical Repair & Upgrades
Installation Specialists
Full Service Shop
Yacht Sales with HMR**

BETA MARINE WEST

Engineered to be serviced easily!

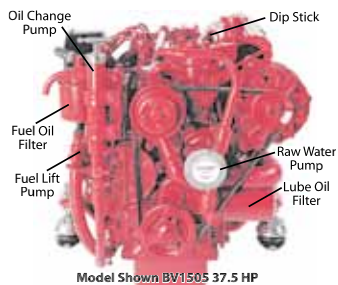

Model Shown BV150S 37.5 HP

SUZUKI MARINE Dealer for Suzuki Outboards

400 Harbor Drive, Sausalito, CA 94965
(415) 332-3507

www.betamarinewest.com
www.hirschfeldyacht.com

REJOIN THE RACE REPOWER WITH VOLVO PENTA



BIG DISCOUNTS WHEN YOU REPOWER WITH VOLVO PENTA D1 OR D2 ENGINES

REPOWERS WITH VOLVO PENTA D1-13 (12 HP)

10% discount + \$500 when you recycle your old engine

REPOWERS WITH VOLVO PENTA D1-20 - D1-75 (19-75 HP)

10% discount + \$750 when you recycle your old engine

- Helmut's will give 10% discount on the net price of your new engine.
- Helmut's will rebate \$500 per D1-13 repower OR \$750 per D1-20 - D1-75.
- All recycled engines become the property of Helmut's Marine or its designee.
- Subject to cancellation or change.

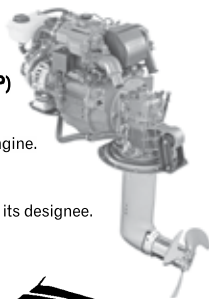

VOLVO PENTA

For more information, contact your nearest Volvo Penta Authorized Service Dealer:

Helmut's Marine Service, Inc.
San Rafael, CA | (800) 326-5135



LETTERS

Impossible Dream that was commissioned by Roy Disney. I am



COURTESY IMPOSSIBLE DREAM

'Impossible Dream' now lives the dream in Puget Sound.

the current owner of *Impossible Dream*, which is now moored in Port Townsend, Washington. I would like to report the boat is alive and well sailing in the Northwest. She spent the better part of last year's sailing season in Southeast Alaska, and has just returned from a short jaunt in the San Juan Islands. The boat has maintained her name since Roy gave it to her in 1970. I believe the name was a result of the successful completion of the full-length animated feature film *Fantasia*, which many thought couldn't be done.

Tom McDowell
Impossible Dream, Morgan 40
Port Townsend

↑↓ DON'T FORGET ABOUT MAKELA BOATWORKS

Your September *Sightings* article on the Spaulding Wooden Boat Center referred to it as the last remaining wooden boatyard in California. Don't overlook one of your faithful ad-



MAKELABOATWORKS.COM

Our apologies to the great crew at Makela Boatworks in Fort Bragg.

vertisers, the well-respected Makela Boatworks, which has been doing business in Fort Bragg since 1947. I speak from personal experience as to the quality of their work, and the honesty and humility of Howard, the current owner and son/nephew of the

original Makela Brothers. Issue #171 of *Wooden Boat* had a great story on the history of the yard.

In the ad for the Spaulding Wooden Boat Center, they refer to themselves as the only "nonprofit" wooden boatyard in California.

Don Furber
Calliope, Ericson 36C
Eureka / Puerto Escondido, Mexico

Don — Thanks for the correction, and our apologies to Howard and the folks at Makela Boatworks. Our boats are plastic, but we respect that 'wood is good'.

↑↓ INFO ON THE LOSS OF JAZZ

I'm responding to the letter from the folks on *Sojourn* seeking info on Tim Nielson from the Bodega Bay-based Alberg 37 *Jazz*. I spoke to him via phone in California after the loss of his boat. He told me that he'd been motorsailing and had his autopilot set for Matanchen Bay/San Blas. Three hours later, he woke up lying on the cabin sole, a large bump on his head and a sizeable bruise on his hip. His boat was in the surf 15 miles north of San Blas, the motor no longer running.

He got his passport and wallet, and swam through the surf to the beach. After he walked a spell, a dirt biker picked him up and took him to a village, from where he was taken



NEW FROM EASOM

SHORT TERM

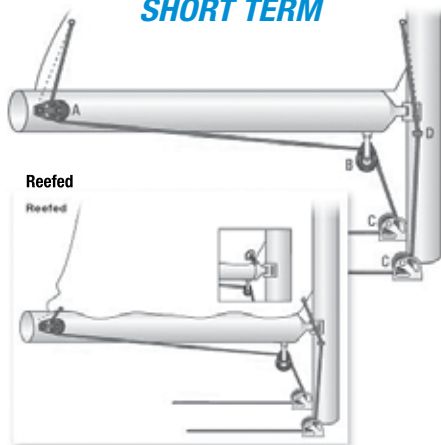

**Booms in stock
for fast delivery.**

LONG TERM

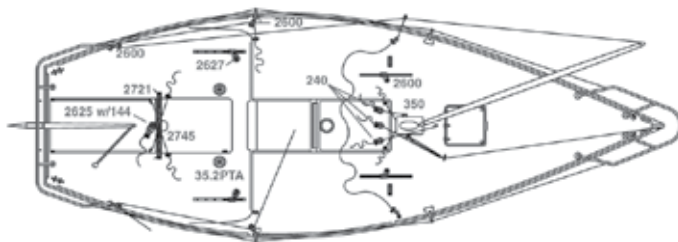

**Plan now to update/upgrade
your deck layout.
Reserve time this winter
for our new indoor keelbox.**

**We handle short-term emergencies
and long-range plans.**



Easom Racing and Rigging

1230 Brickyard Cove Rd., Suite 102
Point Richmond, CA 94801

(510) 232-SAIL (7245)

www.easomrigging.com

Ventura Harbor Boatyard

"For All Your Haulout Needs"
www.vhby.com

TWO TRAVELIFTS
HAULOUTS TO 160 TONS
FULL LINE OF MARINE SERVICES

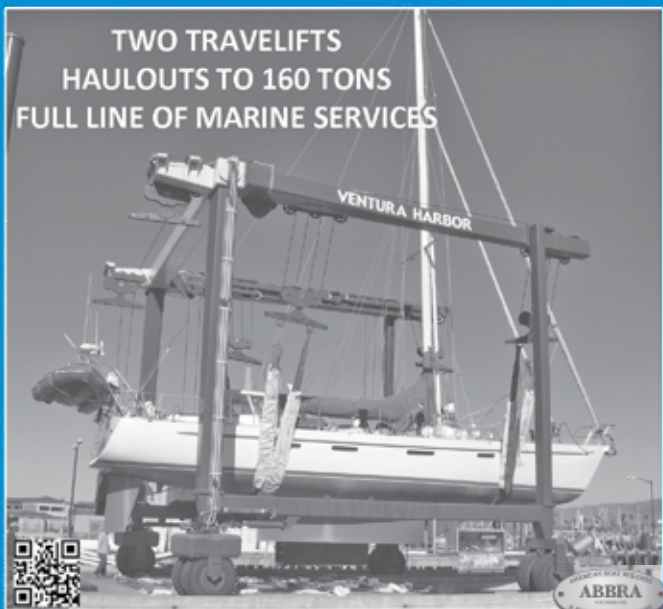

(805) 654-1433

1415 Spinnaker Drive, Ventura, CA 93001



RICHARDSON BAY MARINA

formerly Kappas Marina

MODERN FACILITIES IN A WELL-PROTECTED HARBOR

Concrete — Dock System

Well Maintained Facilities

Beautiful Surroundings

- DEEP WATER BERTHS:
BASIN AND CHANNEL
DREDGED
- CARD KEY SECURITY SYSTEM
- DOCK CARTS
- PUMP OUT STATION
- AMPLE PARKING
- CLEAN SHOWER AND
TOILET FACILITIES
- WITHIN WALKING
DISTANCE: MARKET/DELI,
LAUNDROMAT,
RESTAURANT
- AT EACH BERTH:
LARGE STORAGE BOX,
METERED ELECTRICITY,
PHONE HOOKUPS, WATER

BERTH YOUR BOAT IN SAUSALITO

415 332-5510 www.richardsonbaymarina.com

100 Gate Six Road, Sausalito • Fax 415 332-5812

Mermaid Sails the Bay
Greg Trybull
www.mermaidsailsthebay.com

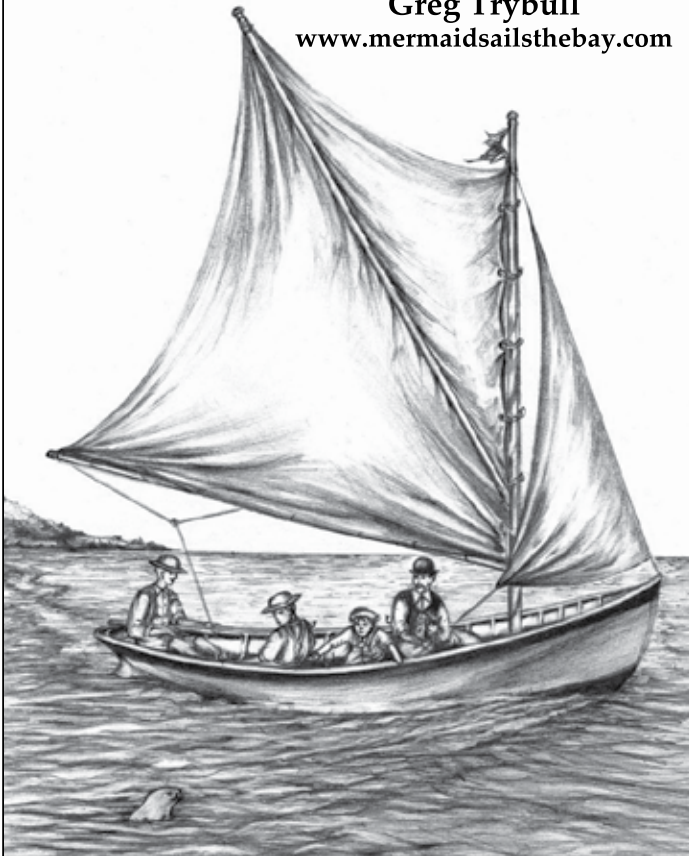

LETTERS

to the hospital in San Blas. He spent a day in the hospital as they ruled out heart attack and stroke, and he had no signs of a concussion. He was delayed another day dealing with the Port Captain about leaving the boat on the beach. When he returned to *Jazz* the next day, she'd been stripped.

Tim was in good spirits when I spoke to him, in good health, and was going back to work to buy another boat. I wish him luck, and hope to see him back down in La Cruz, Mexico, again soon.

Nikk White
Balance, Baba 30
 Portland / La Cruz

↑↓ GOING TO THE DOGS

You had to print a letter about dogs. Isn't your inbox full enough? As a liveaboard with a dog, I feel compelled to respond to some of the complaints in Mr. Name Withheld By Request's letter. I both challenge him and agree with him.

The author mentions "pristine docks" being ruined by dogs. That's a good one. I saw a pristine dock once. It was at Isle Royale National Park in the middle of Lake Superior. There wasn't a spot of dust on it, or poop from dogs or birds. There was no electricity, water, people or roads either. Here in the Bay Area, my boat has been boarded or pooped on by dogs, cats, gulls, tweety birds, rats, herons, raccoons, mice, and the dreaded two-legged 'rat'. Most docks have rat highways — a.k.a. electrical and plumbing conduits. A dog with a good nose can follow them. We also have skunks, but they are rarely on the dock. And even without the boaters these docks are not pristine.

Mr. By Request's solution of punishing pet owners by making them pay a monthly fee won't work. It's done in a few marinas around here already, and that doesn't make them better nor lower the number of pets. And I doubt the money goes to marina improvement. Besides, the pet owners will pay it. Owning a dog is expensive. My vet bill this week was \$125 for an ear infection, and that was one of the lowest bills ever.

But I do sympathize with the poop problem. Pet owners need to be responsible. I once had a liveaboard neighbor who had a cat that used my Cal 25 for a poop box. The owner of the cat always agreed to clean up after her cat, but she never did. The harbor master finally did something about the situation, but many won't get involved. As a result, I have seen docks where everybody with a dog just lets their pooches poop on the dock. Nobody cleans it up, so it becomes stinky and unsanitary and there are flies all around. It seems to be all right with all of them, but it's not a place I would choose to keep my boat.

As a dog owner speaking to other dog owners, please listen up. If your dog is broken, fix him/her by using techniques from the Dog Whisperer. They work. For the rest of you with undamaged animals, the AKC has a K9 good citizenship program.

Name withheld by Request II
 Perhaps the same big marina somewhere

NWBRII — It's true the word 'pristine' is overused, thanks primarily to certain environmental groups who describe anything short of a toxic waste dump as 'pristine'. Nonetheless, we think everyone knows the author was talking about reasonably clean docks. While there may be many different ways to soil docks, is it not fair to say the most offensive kind of dock desecration is dog poop?

As for your claim that additional fees for having pets in marinas won't lower their number, how do you know that? *Maybe*

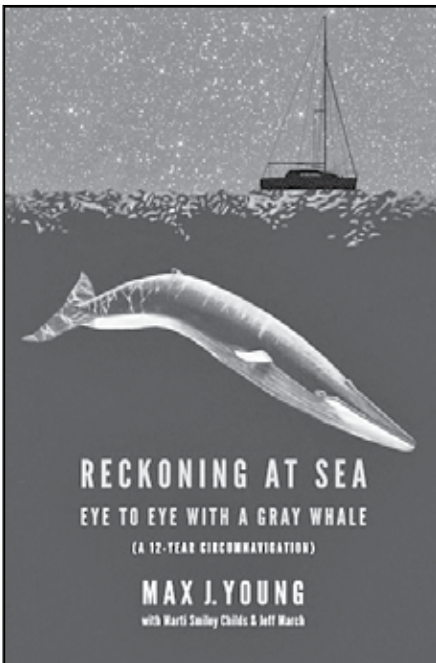

\$15.95
 at
**Amazon and
 Barnes & Noble**

Reckoning at Sea: Eye to Eye With a Gray Whale is a true story about a man living his dream of circumnavigating the world, and his harrowing rescue just 490 miles short of his final destination. As Max Young sailed alone on a dark, moonless night about 60 miles off the coast of Mexico, his life was about to change forever. On June 12, 2012, a gray whale breached and hit the portside stern of his 50-ft sailboat, *Reflections*.

Fast Food or Fine Dining?



Brand
X



Sea Hawk Antifouling paint reflects the epitome of good taste. Reserved for those with an appetite for the finer things in life, Sea Hawk is the crème de la crème in antifouling solutions. Our menu comes with a written guarantee. From self-polishing to bio-engineered environmentally-friendly formulas, you can count on Sea Hawk for the well-being of your boat's underbody. Fast food or gourmet? Make the right choice for you and your yacht.

Where to find
Sea Hawk near you



OVER
35
YEARS

NEW NAUTICAL COATINGS, INC.
800.528.0997 U.S.A. Only • 727.523.8053 International
Email: contactus@seahawkpaints.com

www.SeaHawkPaints.com

**Sea
Hawk**
PREMIUM YACHT FINISHES



Family Owned & Operated since 1978



NAPA VALLEY MARINA = SERVICE

CALL
US
TODAY!



- Engine repair – diesel and gas
- Shaft Alignment
- Outdrive repair
- Bottom Jobs –
- Gel Coat Repair
- AWLGRIP** Paints

WE CAN HAUL LARGE CATS/TRIMARANS

California's Largest Dry Storage Facility

NAPA VALLEY MARINA

1200 Milton Road • Napa, CA 94559
(707) 252-8011 • Fax (707) 252-0851

www.napavalleymarina.com

Marina • Boatyard • Chandlery • Brokerage

Dealers for
YANMAR

Interlux
yachtpaint.com

Distributors for *Brownell*
Boat Stands

Worst Nightmare.

Why compromise safety? Get an Ultra Anchor.



Ultra Anchor is certified by the American Bureau of Shipping (ABS) to meet their highest level of holding power for use on ABS class vessels. SHP certification is awarded to anchors with superior holding power of at least four times that of ordinary anchors.



QUICKLINE
Home of the Ultra Anchor

714 843-6964
www.quickline.us

VIDEO



Let Hydrovane sail you home safely.

WHAT IF...

- Autopilot fails
- Batteries are dead
- Engine won't start
- Steering broken
- Rudder is damaged
- Crew incapacitated

NO WORRIES WITH HYDROVANE

Totally independent self-steering system and emergency rudder... in place and ready to go.



Jean and Stephanie on SV Le Letty, a Roberts 44 Ketch, in Barra de Navidad, Mexico. Hydrovane mounted with dinghy davits.



Joel on SV Compañera, a Tartan 3800, in La Paz, Mexico. Hydrovane mounted off-center to preserve the swim platform.



WWW.HYDROVANE.COM



1.604.925.2660
info@hydrovane.com

SURVIVE YOUR DREAM

LETTERS

if there were no fee, there would be twice as many pets. And if the pet fee were \$1,000 a month, we don't think there would be many pets at all.

As we've written before, we're neutral on pets. We know they are the key to the happiness and emotional well-being of many people, and think that's great. Well, great as long as the owners clean up the poop in public places and on other peoples' property, and that the owners understand any contact between the pet and strangers should be initiated by the stranger. What's with pet owners who think the time to control their dogs is after the dog has slobbered all over somebody? How would they feel if a stranger came up and gave them an unwanted slobber?

We're also a little confused by growing sense of entitlement felt by dog owners in California. Last Friday we were at Fior d'Italia at the San Remo Hotel in San Francisco with friends from the Caribbean, and customers brought not one, but two medium-sized dogs into the bar. While they only had one short barking fit, they made themselves easy to trip over and took up much of the room under the tables usually used by human legs and feet. The next day we watched the America's Cup at the 2 A.M. Club, Mill Valley's only dive bar, with a guy from the Artemis syndicate. Another guy came in with the biggest Great Dane in the world, who merrily made himself comfortable right in the middle of a main walkway. The dog's owner was typically oblivious to the obstacle the friendly beast made. To top it off, the next day we were in Mill Valley's secular temple, the big Whole Food Store, when a girl, about 10, came in with her dog, and obviously pranced around with the dog as though it were the family home. What next, dog walkers bringing their horde with them to doctor's appointments?

↑↓ HOW LONG HAVE YOU BEEN TRUCKING BOATS?

I'd like to respond to the August issue letter regarding getting boats from one coast of the United States to the other. The *Latitude* editor did an admirable job of explaining the pros and cons of various delivery methods, and it's certainly true that trucking a boat is still the most cost-effective option in the vast majority of cases. I'm very pleased that *Latitude* mentioned the cost-saving concept of connecting with an existing load, so that trailers don't travel empty. This is beneficial to the customer (saves money), the trucking company (saves money/lost time), and the environment (reduces unnecessary fuel consumption).

It can be difficult, however, to find these deals, which can easily save the boat owner 30% or more. To that end, we at San Diego Boat Movers have established an online tool to easily connect boat owners with empty trailers that are available in their area. We also have a user-friendly quoting tool so it's much easier to get an idea of the cost up front. Please feel free to share this with your readers:

Connecting Loads: sandiegoboatmovers.com/boat-hauling-by-road/shipping-boats-across-country
Free Quotes: sandiegoboatmovers.com/boat-hauling-by-road/boat-transport-cost

Leland Parsons
San Diego Boat Movers

Delivering boats nationwide since the dawn of time

↑↓ CAUTION WHEN CAREENING

Latitude wanted to know where and when people had beached their boats so they could work on the bottom without having to pay for a haulout. In the early days — meaning 1984 to 1992 — of my 40-ft cat *Minette*, we used to beach her in the shallow lagoon behind Ballast Point at Cat Harbor, Catalina.

Albatross Boathouse
Home of
THE DINGHY DOCTOR
SALES AND SERVICE OF INFLATABLE BOATS AND OUTBOARDS
www.thedinghydoctor.com
3302 Kurtz St., San Diego 92110 **619-804-6921**

Come see our 8,500 sq. ft. indoor showroom at our new location off I-5 & I-8

Powered By Honda

Run with the Leader!

Inflatable boats and RIBs of all sizes fully rigged with Honda outboards. We offer complete service on all Honda outboards with computerized diagnostics & factory trained technicians.

**Achilles, AB, Caribe, Fiji and Taurus Inflatable Boats
Klamath and Bayrunner Aluminum Boats**
Powered by Honda

Always wear a personal flotation device while boating and read your owner's manual. 2008 American Honda Motor Co., Inc. ®

OASIS IN THE HEART OF MONTEREY

new Expanded Guest Slips to 200-ft!

Breakwater Cove Marina
at the historical entrance to Cannery Row
Central to the best of Monterey

Deep Water

Your Perfect Summer
Cruise Destination
Boating clubs welcome

Reservations: Diane (831) 373-7857
www.montereybayboatworks.com



Serving the Bay Area
Since 1986

Seashine

Service of the Month

WASHDOWN

Soap, water and TLC will remove the salt,
uncover the shine, and preserve the value.
A wise investment!

ADDITIONAL SERVICES
Interior Cleaning • Detailing • Maintenance
Polishing • Carpet & Cushion Cleaning

Fully Insured & Marina Approved
Call now for a Free Estimate

510 428-2522 or 415 457-6300
www.seashine.net

Captain's License

Maritime  Institute

Captain's License Training

Maritime Institute has a course Near You!
From *San Rafael* to *San Diego*
or *On-line* at your own pace

- ✓ OUPV up to 100 GT
- ✓ Able Seaman
- ✓ Radar and Radar Renewal
- ✓ FCC License Exam - MROP
Marine Radio Operator Permit

Toll Free: 888-262-8020
www.MaritimeInstitute.com

WE WANT YOUR BOAT LOAN



WEST COAST REPRESENTATIVE
Max Salvater
888-898-2476
max@boatbanker.com

HIT THE WATER WITH A GREAT RATE!
AS LOW AS!
3.69%^{APR}

Visit us at...
www.boatbanker.com



Direct benefits

It's easy! With your new sail order from **North Sails Direct** you measure, you SAVE, you get the best. **Contact us today!**

FREE!
ONE YEAR SAIL CARE & REPAIR
 with purchase of a new North sail*

*Restrictions may apply. Ask your North Sails Direct representative for details.

NORTH SAILS direct

northsailsdirect.com or call **888-424-7328**
 Boat size restrictions may apply.

LETTERS

We'd place the boat in the tiny bay, put plywood down on the mucky sea-floor, then some milk crates, and wait for the tide to drop. We'd quickly clean, dry and paint the bottom before the tide came back in.

We went to do it again several years later, but were quickly kicked out by the Island Company, which claimed jurisdiction over all the waters "inside Cat Harbor."

Mike Leneman
 Multi Marine
 Marina del Rey

Mike — We're not going to mention any boat names, but we know that at least one large catamaran put her fixed keels on the hard to do work both at a popular island off the coast of California and on a beach in San Diego this summer. The owner was probably able to get away with it because he was just working on thru-hulls and not sanding and painting the bottom.

To illustrate an example of beaching a multihull, the accompanying shot is of Thor Temme's Kauai-based 44-ft cat-rigged trimaran ketch Meshach. If we remember correctly, the photo was taken about four years ago near Isla Partida in the Sea of Cortez. As all the islands are part of a national park, it's unclear what rangers would think about it, although as long as there was no pollution, they probably wouldn't mind.

That said, a month or two ago Robin Kirkcaldie of the Santa Barbara-based Red Witch II careened his Bounty II on a beach



COURTESY MESHACH

The Temme family beached their tri 'Meshach' near Isla Partida a few years ago.

in the northern Sea of Cortez. In that part of the Sea, there's hardly anybody to mind anything. By using the word careened, we indeed mean to indicate that Red Witch II is a monohull. If things weren't properly stowed,

it could be a real mess inside, as she was probably heeled over more than 45 degrees. Oddly enough, the last monohull we can remember being intentionally careened was Max and Vera Zenobi's Sausalito-based Bounty II Maverick. That was about 30 years ago on the Pacific Coast of Panama, where tides can run 15 feet or more.

DEFYING VERTIGO TO GO SAILING

After a half-decade of not being able to sail due to nasty vertigo from Meniere's disease, I've finally gotten things sufficiently under control to consider going sailing again. When I couldn't go on or even near my boat, I quit picking up *Latitudes* because reading them made not being able to sail even more painful. So I hadn't looked at an issue until July.

As I was reading that issue, I came across a discussion of whether there was a preferred way to reef a cat. So I was reading the question and the response, and wondering what in the world these folks were thinking. Center the main on a cat going downwind instead of chicken gybing? And then I realized that the cat under discussion isn't a catboat, but a catamaran. The only thing catboats and catamarans have in common is the need to reef early and often.

I wish there were more catboat and una rig sailors on San Francisco Bay, so we owners could hang out and talk about

The Cup is coming – slips are going!



Making boating easier – and more fun! – is what Oyster Cove is all about.

America's Cup boats are already here! Take advantage of Oyster Cove's great location. Near the races and practices, as well as SFO and mass transit, Oyster Cove is the private marina best for America's Cup convenience.

OYSTER COVE MARINA

385 OYSTER POINT BOULEVARD #8A,
SOUTH SAN FRANCISCO

(650) 952-5540

- Berths 30 feet to 60 feet
- Double Finger Concrete Slips
- Five Minutes from SFO
- Close to Mass Transit
- Heated Dressing Rooms & Showers
- Laundry Room
- Nightly Security Patrol
- Complimentary Ice

www.oystercovemarina.net



McGinnis Insurance

Since 1972

**We Specialize in Coverage for Yachts and Boats
with Agreed Value Policies.**

We Only Represent "A" Rated Companies.



Boat Fest October 3-6 • Marina Village

Call us at: 800-486-4008

mcginnisins@aol.com † License #0570469

AQUAMARINE INC.

Watermakers Since 1987

**SPARKLING FRESH WATER, POWER, AND
REFRIGERATION FROM THE SEVEN SEAS**



AquaGen combines the quality, simplicity & reliability of AquaMarine, Inc. watermakers with the durability of the Kubota 150 amp 12V diesel generators. This compact low fuel consuming AquaGen is a powerhouse, capable of producing up to 150 amps, and 8 up to 62 GPH of fresh potable water from any water source. Make fresh water, refrigeration, and also charge your batteries all at the same time! A hydraulic pump may also be added to run your dive compressor, windless, bow thruster, or emergency bilge pump. Ideal for longterm cruisers or weekend wanderers. We custom engineer our systems to fit any size vessel or cabin site. Electric, Hydraulic, or Belt Driven Modular Kits are also available. Visit our Website for more information.

**QUALITY AT AFFORDABLE PRICES.
LIFETIME WARRANTY ON PUMP HEAD AND PRESSURE VESSELS.**
AquaMarine, Inc., 58 Fawn Lane (P.O. Box 55) Deer Harbor, WA 98243 USA
(800)or(360) 376-3091 Fax (360) 376-3243

www.aquamarineinc.net

LETTERS

the joy of sailing the best inshore boats in the world. Our *Nala* has three reef points and generally leaves the dock with the first reef in, since no reefs is generally the cat rig version of flying a big light air genoa.

Nadja Adolf
Nala, Seaward 23 (una rig)
Newark

Nadja — Since you weren't reading *Latitude* last October, you probably didn't know that *Doña de Mallorca* was laid low for 24 hours during the middle of the SoCal Ta-Ta by a severe case of vertigo. We had no idea it was such a wicked malady. Fortunately, it seems to have been an isolated incident in her case. We hope yours is truly under control.

↑↓ THE LAST LETTER ON REEFING CATS

Seeing the article on reefing reminded us of a certain person in the Seattle area who took a 34-ft Gemini 105 cat out in big winds — reportedly 70 knots. The boat flipped when, according to rumor, the mainsheet wasn't released fast enough.

We've owned our 'little kitten', a 1986 sistership to the Gemini that flipped, for 20 years. Before we left the Seattle area in 2004 to do the Ha-Ha and cruise full-time, we installed a simple quick-release on the mainsheet block. It's a last resort that thankfully we've never had to use.

While cruising in the Galapagos, we once got hit by a big squall that made dropping the main quite trying, and required a lot of muscle. With a main the size of the main on *Profligate*, I'm sure it would be a much bigger problem.

We've learned that you don't need Batt Cars on a catamaran to reef, you just need a paranoid wife such as mine who makes me reef way early. Reefing early also makes for a happy marriage, and we get to keep cruising.

Rob & Linda Jones
Cat 'n About, Gemini 3000
La Paz, Mexico

↑↓ ROOTING FOR NEW ZEALAND

Having read the September 11 *Lectronic*, I have to ask: Do you really not understand why most local fans are rooting for Emirates Team New Zealand? It isn't cheering for the underdog. New Zealand is never an underdog. It's all about Ellison's hubris, bad decisions, and several PR disasters.

Ellison has made the America's Cup a billionaire's playground more than ever before. His choice of boat design has taken it out of the realm of fantasy for us mortal sailors. He has made it so expensive to compete that, out of a dozen entries in the 2012 World Series, only four could afford to compete for the Cup itself. That is a killer for spectator interest. Then we had the Artemis disaster, followed by the Louis Vuitton Cup, in which all it took to win was for a boat to cross the finish line. Add to that the ridiculous wind cancellations, blacked-out TV and YouTube broadcasts and Oracle's cheating, and it's hard to imagine how anyone could root for Ellison's team.

The boats are technological marvels and exciting to watch. The regatta is a complete fiasco.

Elan Caspi
Belmont

Elan — We understand what you're saying, and should note that you wrote it before the Cup Finals, which have been a smash. We'd also point out that it's not at all uncommon for fans to detest the owner of a team while loving the team itself.

1893

2013

Patent Pending

Elco

120 years

of ELECTRIC PROPULSION

elcomotoryachts.com
877-411-ELCO | Athens, New York

Every Mack Sail Is Proudly Made In Our Stuart, Florida Sail Loft

Our 45th Year

KANTER 52 PROJECT
We built all new sails for this Kanter 52 that was fitted out for circumnavigating. Our rigging department installed a Leisure Furl Boom and Furling Code Zero. MACK SAILS also painted spars, replaced all standing and running rigging, updated deck hardware, hydraulics and electronics.

LIKE us on Facebook

Photo: Kip Brundage

The Biggest Small Loft In The USA

Call (800) 428-1384
info@macksails.com
www.macksails.com

Colin Mack & Travis Blain

WE SHIP EVERYWHERE AND PAY THE FREIGHT ON NEW SAILS AND MACK PACKS.



INSURING BOATS & YACHTS FOR OVER 50 YEARS

Contact Us for a Quote

www.marinersins.com

Exclusive
MARINERS *Odyssey*® Program

Mexico
South America
South Pacific
Caribbean
Mediterranean

Racing Sailboat
Program

Transpac
Pacific Cup
PV / Cabo Races
Caribbean Regattas

Providing Cruisers and Racers All Over the World
with Prompt, Reliable Service since 1959

Corporate Office: 206 Riverside Ave., Suite A
Newport Beach, CA 92663 / Ins. Lic. #0D36887

N. California*
boomeins@aol.com
800-853-6504
*Independent Agent

L.A./Orange Co.
800-992-4443

San Diego
800-639-0002



OPEQUIMAR

MARINE CENTER CENTRO MARINO

Our Experience Makes the Difference



High velocity pump fuel dock, 46 gals./min. • Travelift: 88 tons, 100' length, 23' beam
Dry storage for vessels up to 300' • VHF radio ch. 68 • 24-hour security • Dock rentals
Sales & rent of used & new boats • Full service boatyard • Do-it-yourselfers welcome

The Most Complete Marine Center Open 365 Days
Puerto Vallarta, Jal. Mexico / Tel: (322) 221-1800
www.opequimar.com / info@opequimar.com

2014 MODELS ARE OUT!

Clearance Sale on 2013 Models



Unsurpassed Fuel Economy

- Quiet, 4-stroke technology
- Transistorized pointless ignition
- Ideal for sailboats, small tenders



POWERED BY

HONDA
MARINE



© 2013 American Honda Motor Co., Inc.
Always wear a personal flotation device while boating and read your owner's manual.
5-year warranty standard on all new Honda outboard engines purchased.
Check with participating dealers for complete details.

Outboard Motor Shop
Where the professionals shop!



(510) 533-9290

www.outboardmotorshop.com



333 Kennedy St., Oakland, CA 94606 • Fax 510-533-3374

NEW MEMBERS WELCOME Celebrating 100 Years



- 20+ Cruise Outs a Year
- Host 25 Races a Year
- 20+ Social Events a Year
- Full Dining and Bar
- OYC Owns Our 220-Slip Harbor



Oakland Yacht Club
in Alameda, CA

Call For A Tour Of Our Club

Call (510) 522-6868

www.oaklandyachtclub.com



MARINE INSURANCE SPECIALISTS

**Your best source for Yacht and Boat Insurance
tailored to your needs and competitively priced**

We Insure:

Sail or Power ♦ Classic or Contemporary
Fiberglass ♦ Aluminum ♦ Steel ♦ Wood

At Heritage Marine Insurance you will find knowledgeable insurance professionals who provide superior service and the finest coverage available today.

To be sure you're getting the best insurance value please contact us for a quote.

www.heritagemarineinsurance.com

800-959-3047

Fax 860-572-5919

classics@heritagemarineinsurance.com

Program available exclusively through:



LETTERS

↑↓ THE PENALTY WAS TOO SEVERE

The losers in the AC45 'cheating scandal' are the jury. Nobody has shown how much difference, if any, these enhancements made. In fact, the so-called "enhancements" are insignificant. Show us the difference in the results that resulted from the addition of these enhancements.

The two-race penalty was too severe and really tarnished an already tarnished America's Cup. If New Zealand wins by just two races, there will be an asterisk after their victory noting the penalty against Oracle. The penalty does not fit the crime, which was committed in a previous series. I suspect most sailors, no matter who they are rooting for, will be rooting for an even playing field as AC 34 begins.

Patrick McCormick
St. Somewhere, Beneteau 440
Alamitos Bay

Readers — This letter was written before the start of the Cup Finals, which turned out to be such a great success.

↑↓ IF YOU CAN'T BEAT 'EM, CHEAT 'EM

As the saying goes in motor sports racing, "If you can't beat 'em, cheat 'em. It's our job to cheat, it's their job to catch us."

This is what happens when yacht racing tries to emulate NASCAR. It's all about the money now.

Bob White
Scotts Valley

Bob — When we were young and naive, we liked to think that sailors were a cut above, and valued sportsmanship and fair play above all. Over time, we learned that there were those



GILLES MARTIN-RAGET/ACEA

Oracle really tripped — in more ways than one — when their AC45 was 'modified' last year.

so intent on winning that they'd spend lots of money to 'bend' the rules. Such as taking boats up to Stockton to get an IOR certificate because being measured in fresh water resulted in a better rating than when measured in salt water. Or soaking all the halyards in water to make the boat a little less stable. These were relatively minor bendings of the rule. Then Dee Smith, one of the most sought-after international sailors to ever come out of Northern California, told us about the time many years ago that he was crewing on a boat in the SORC — then the most prestigious racing series in the United States — when they were becalmed and turned on the engine. Appalled beyond belief, Smith got off the boat as soon as they reached the dock and never spoke with the rest of the crew again.

That's the thing about yacht racing; it's only as good as the integrity of the participants. Sure you can have checks, but if somebody wants to cheat, there will be opportunities. The thing that disturbs us is that if Oracle or some rogue member of the Oracle team made those illegal changes to the AC45s, what other and more effective illegal changes might they have made?

We realize that in many sports, trying to cheat without getting caught is considered to be part of the game. But we like



Discover

Brisbane
Marina



GREAT LOCATION! Just minutes to Central Bay sailing.
GREAT STAFF!
GREAT RATES! Starting at \$6.02/foot!
MARINA GREEN with picnic/BBQ areas,
 Bay Trail Access and FREE Wi-Fi.
HOME OF THE SIERRA POINT YACHT CLUB



From Hwy 101, take the Sierra Point Pkwy exit and follow the signs to the marina.

400 Sierra Point Parkway
Brisbane, CA 94005

www.ci.brisbane.ca.us

(650) 583-6975

harbormaster@ci.brisbane.ca.us

STARBUCK DODGERS

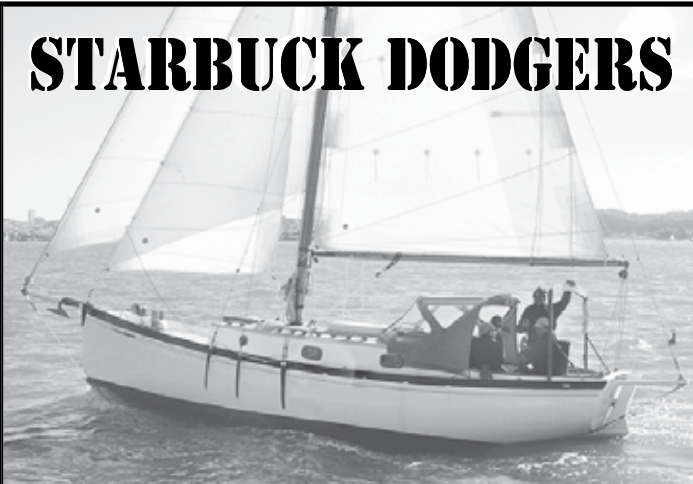

ALWAYS...

Dan Jones aboard *Apster*,
as seen in Sightings, Feb. '04

LOOKING GOOD!

STARBUCK



CANVAS WORKS

67 Liberty Ship Way, Sausalito, CA 94965

415 332-2509

Montgomery Boats

15 • 17 • 23

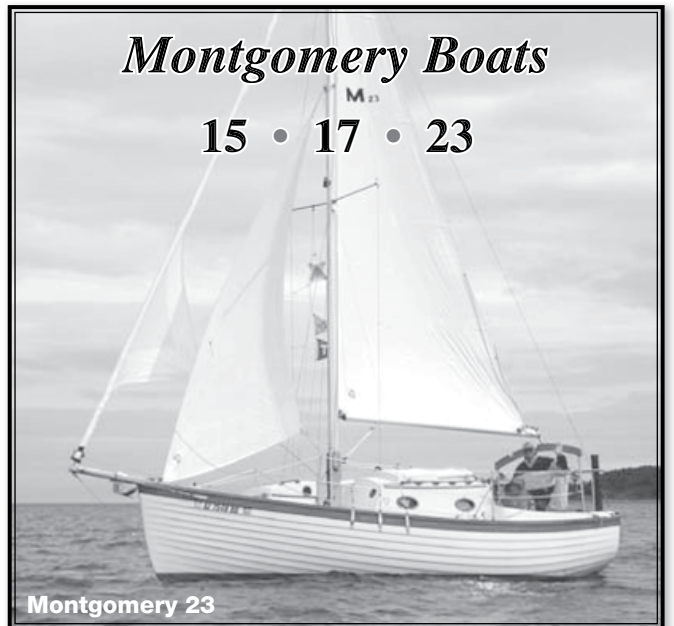

Montgomery 23

Nor'Sea Yachts 27 • 37

Tenders 7 • 8 • 10 ~ a size for all!

(855) 460-4455 | (949) 489-8227

www.montgomeryboats.com

www.norseayachts.com

BLUE WATER YACHT INSURANCE

Blue Water Yacht Insurance covers more active cruising boats than any other marine agency in the Western Hemisphere.

Our Insurance Programs Provide:

Crew of two anywhere • Worldwide Navigation
Charter Boats • Multihulls • Liveboards • Racing Boats

Quality Rated Insurance Companies

Boats aged 1 to 40 years • "Agreed Value"
"All Risks" • "New for Old" replacement partial losses
Hulls valued \$50,000 to \$25,000,000

Worldwide Health Insurance

International and USA health insurance plans
at affordable prices.



BLUE WATER
INSURANCE
MARINE • YACHT • RACING

Call Toll Free (866) 463-0167

Fax (866) 795-3707

sales@bluewaterinsurance.com

Quote requests

Visit our website

www.bluewaterinsurance.com

LETTERS

to continue to like to think that yacht racing is different.

↑↓ BLOODY CHEATS

Bloody cheats. Of course, Oracle management knew about the changes to the AC45s. Now we'll have to put up with the whining that is sure to follow Oracle's losing the Cup.

Cheating, for heaven's sake, oh please.

James Baker
Telegraph, Morgan 382
Lahaina, HI

James — What you 'know' and what you can prove are two different things, aren't they?

↑↓ WHAT'S THE CONNECTION?

I have yet to hear what the mechanism is whereby a penalty in a race seemingly unrelated to the actual America's Cup is assessed to an actual America's Cup team. Can you explain to the readers what the connection is between the AC45s and the America's Cup?

Al Fricke
Meridian Passage, Valiant 40
Northern California

Al — The rationale is that the AC45 World Series and America's Cup are part of the same event. If you didn't participate in the World Series, you couldn't participate in the Cup.

↑↓ NOT AS UNRELATED AS IT MAY SEEM

I think the Oracle AC45 offense had nothing to do with the America's Cup. The World Series was a separate event invented by Oracle. Personal punishment and fines are fine, but to take two races away in the Cup finals was excessive. There is no direct connection between the two series, which makes it akin to taking points away from a boat racing TransPac because a crewmember used an illegal part on a Laser race.

Bruce Powell
Calou, Jeanneau 47
Tiburon

Bruce — On the surface it seems as though they were different events, but they were actually two parts of the same event.

↑↓ CREDIT WHERE IT'S DUE

Just a heads-up. The Master Mariners Regatta is managed by Sausalito YC and has been for decades. I know, as I've been the PRO for the past 10 years, and they had it long before that. The Encinal YC simply hosts the party. If the Sausalito YC could get some credit, I'm sure they would appreciate it.

Jeff Zarwell
RegattaPRO.com

Jeff — Thanks for clearing that up, as it's been one of the more popular events on the Bay for many years.

In a typical month, we receive a tremendous volume of letters. So if yours hasn't appeared, don't give up hope.

We welcome all letters that are of interest to sailors. Please include your name, your boat's name, hailing port and, if possible, a way to contact you for clarifications.

By far the best way to send letters is to email them to richard@latitude38.com. You can also mail them to 15 Locust, Mill Valley, CA, 94941, or fax them to (415) 383-5816.

NEW RIGID HATCH COVERS

Rigid cover
protects hatch lens

•
No more crazing
& hazing!

•
Easy, no-holes
installation

•
More efficient
cooling & heating

•
More comfortable
cabin interiors



Made in
USA 

The next generation in hatch covers

www.OutlandHatchCovers.com
336.403.1488

**HOME TO
EMERYVILLE
SPORTS
FISHING**

Emeryville Marina



ON THE BAY

NEW SLIPS!

Now taking reservations
for 40' to 60'

*When you call Emeryville Marina Home...
...call this your backyard!*

**Free Wi-Fi
and Video
Surveillance**

Slips from 20-65 ft
Full Amenities - including
Fuel Dock & Pumpout Station

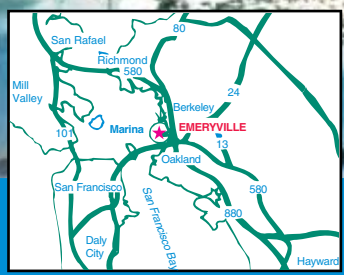

MARINAS
International

(510) 654-3716

www.emeryvillemarina.com

VOLVO PENTA

VOLPAR, INC.
**Parts &
Service**

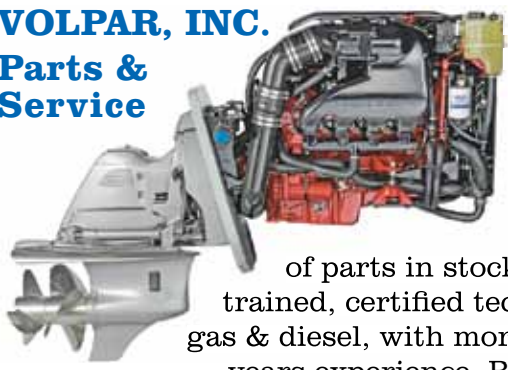

Your local Penta dealer with a large inventory of parts in stock. Factory trained, certified technicians, gas & diesel, with more than 30 years experience. Bring your boat or have our mobile service come to your boat.

Open Tuesday-Saturday
10 a.m. to 7 p.m. PDT

www.volpar.com
volpar@volpar.com
941 Laurelwood Road
Santa Clara, CA 95054
toll-free (800) 845-2323
local (408) 986-0848 fax (408) 986-8482

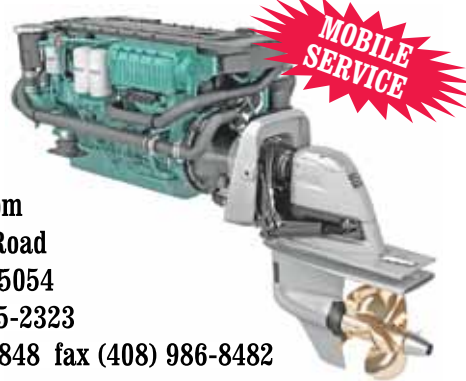

KISSINGER CANVAS

Marine Canvas & Interiors
STEVEN KISSINGER
(925) 825-6734
Covering the Entire Bay Area

- Biminis
- Enclosures
- Boat Covers
- Cushions
- Sail Covers
- Awnings



DODGERS

20 Years in Business

Side handrails and window covers included.

OPTIONS

Aft handrail, dodger cover, sailing bimini.

Free Estimates and Delivery

rolex big boat series preview

Although the annual Rolex Big Boat Series will have concluded by the time you read this, the following analysis will serve as a preview to our November edition coverage.

After several years of declining numbers, the Rolex Big Boat Series (September 26-29) has bounced back from last year's disappointing total of 66 entries to a once-again impressive total of 110 entries. Why? Because they let small boats race in the 'Big' Boat Series. For the first time ever, boats under 25 feet comprise nearly half the fleet.

Across the nation, whether it's Key West, Charleston, Block Island or the West Coast, big boat numbers have been on the decline at major regattas while small boat entries have exploded. Now RBBS is no different. The largest class by far this year is that of the classic one-design sportboat, the Melges 24. RBBS will serve as the Melges 24 Pre-Worlds,

and has attracted an astounding 40 boats from 12 nations.

Also in attendance for the first time ever is the all-new J/70 sportboat, which has drawn eight entries for its San Francisco debut. The inaugural J/70 North Americans are the same weekend in Annapolis and feature a 90-boat fleet. With a rapidly growing fleet

that is outpacing old J/24 sales, expect the "small boat revolution" to be a permanent feature of the Big Boat Series from now on. Starting right in front of the race deck and running short courses, the J/70s should be one of the most entertaining classes for spectators.

One of the most exciting classes of the regatta will be the HPR class. With four J/125s, a McConaghy 38 and a Farr 400, this is the one to watch. Aboard the defending champ J/125 *Double Trouble*, skipper Andy Costello and crew will have their hands full battling Trevor Baylis and a stacked crew on the J/125 *Resolute*, while Greg Slyngstad's *Hamachi* (also a J/125) is also said to have a very talented crew. Don Payan's McConaghy 38 *Whiplash* should fare well under the HPR rule, if given the right conditions and with good sail handling. Long joked to be the 'Help Premier Racing' rule, HPR was literally written around the Farr 400. Could this finally be the year that the Farr 400 does well at Big Boat? Rumor has it that the HPR class will run random-leg courses, as will the multihulls.

For only the second time in the long history of RBBS, a multihull class will be included in the fleet roster, and what a class it is. With Tom Siebel's awe-inspiring MOD 70 *Orion*, plus a Marstrom 32, a SL 33 stacked with American Youth Sailing Force sailors, a ProSail 40 and Bill Turpin's venerable little D-Class *Rocket 88*, the two- and three-hull class should make for some fantastic racing.

Always one of the most posh and competitive events of the year, the Rolex Big Boat Series lives up to its reputation with 22 J/105s, 7 J/120s and a healthy IRC fleet. It has also once again attracted some of the West Coast's — as well as the world's — top sailors. While many big-boat regattas are on the decline, San Francisco's fall classic is on the rebound due to good decision-making.

By allowing small boats and multihulls, and catering to new rules like HPR, RBBS has changed with the times. With an impressive roster of entries, while running literally on the heels of the world's most important inshore regatta — America's Cup 34 — the Rolex Big Boat Series is once again cementing its place as a regatta of international relevance. Find out more at www.rolexbigboatseries.com.

— ronnie simpson

pdf implicated in

Last month, US Sailing released their independent review panel's report on the March accident that took the life of San Diego sailor Craig Williams, a crew-member aboard the Columbia Carbon 32 *Uncontrollable Urge* in the Islands Race. That report points a finger at the Spinlock Deckvest lifejacket, which Williams and four other members of the six-man *Urge* crew were wearing, as a factor in Williams' untimely drowning at age 36.

According to the report, the construction of the PFDs allowed the inflated bladders to pull over the heads of four of the crew — including Williams — in the



MOD S.A./YVAN ZEDDA

The MOD 70 'Orion' will be one of the shining stars of the Rolex Big Boat Series.



The start of St. Francis YC's Rolex Big Boat Series nearly coincided with the final race of the America's Cup.

sailor's drowning

rough surf they swam through to reach shore. "The deceased was found floating face down with the flotation chamber pulled over his head," the report noted. "Given that the crew had to swim through large surf to reach the shore, this was a life-threatening failure."

Practical Sailor, which had given the PFD in question a 'recommended' rating in previous tests, set to work re-testing the vest. While they were unable to replicate the failure, they noted that most inflatable PFDs on the market feature air bladders that are either sewn or thermo-

continued in middle column of next sightings page

dorade's busy schedule

After Matt Brooks and Pam Rorke Levy's 83-year-old S&S 52 *Dorade* stunned the yachting world by taking overall honors in this year's very competitive TransPac — 77 years after she won it overall the first time — the slim classic yacht didn't rest on her laurels. In fact, last month she was shipped to Newport, Rhode Island, from where Brooks and crew will later sail her down to Antigua, which will be her Caribbean homebase for the winter of 2013-'14. *Dorade* has already had a lot of fun in the Caribbean, winning her class in the Voiles de St. Barth in 2011.

Some owners of classic yachts believe they are for coddling as floating museum pieces. Not Brooks, a Fremont-based member of the St. Francis YC who spent more than a year and a lot of money having the legendary yacht completely restored in the Northeast after he bought her a few years ago. That being the case, he's got a busy

continued on outside column of next sightings page



SIGHTINGS

***dorade* — cont'd**

schedule planned for her in the sunny Caribee this winter. First, on February 24 *Dorade* will start the challenging Caribbean 600, which takes a superb fleet weaving through the islands of the Caribbean for — you guessed it — 600 miles. Come late April, she'll participate in the BVI Spring Regatta, which has both a very competitive racing and very lively social program.

Following that, the plan had been for Pam Levy and a group of women sailors to enter *Dorade* in the Voiles de St. Barth again. But that may not be possible as, for inexplicable reasons, the race organizers — our friends François 'Toto' Toledé and Lucky Poupon — have eliminated the classic division and rescheduled the event for the same April dates as the Antigua Classic Regatta. Matt and Pam love the Voiles de St. Barth, but if we can't convince Toto and Lucky to let them enter, Pam and her women's team will do the Antigua

continued on outside column of next sightings page

pdf

welded to the vest, but the bladders in Spinlock vests are joined to the vest in three places, with a strap on the right side holding the bladder close to the vest.

"It seems that in heavy surf, a person's head can squeeze through the gap between the vest and the bladder (or the entire left side of the vest slips over the head)," they wrote on their blog, "and the PFD assumes this new lopsided position with the bladder on one side only."

They go on to point out there are many variables that could make any PFD slip over the wearer's head, including a loosely fitted vest, one that's not fully inflated



LATITUDE / RICHARD

— cont'd

and heavy breaking waves. James Hall of Spinlock agreed: "In our own testing, we found that the correct, secure fitting of the chest belt and leg or crotch straps have the largest impact on the performance of all lifejackets."

Regardless, the review panel "recommends that Spinlock and other manufacturers examine the design of their inflating vests and consider making the inflation chamber more secure to the harness." Read the full report at tinyurl.com/kq93514, and *Practical Sailor's* blog at www.practical-sailor.com/blog.

— ladonna



Pam Rourke and Matt Brooks have a busy schedule planned for their lovingly restored 'Dorade'.

dorade — cont'd

Classic Regatta instead. Not that the latter isn't the premier classic regatta in the Caribbean.

"We're firming up our women's crew," says Pam, "but J.J. Fetter, formerly Isler, will be the helmswoman, and she'll be joined by Pamela Healy, and hopefully Jenny Tulloch, Paige Brooks, Laurel Gaudec and myself, all of whom were members of *Dorade's* victorious Leukemia Cup team."

"Don't forget Hannah Jenner," added Matt.

"Oh, yeah, Hannah, who was part of the victorious TransPac crew."

"After the season in the Caribbean," says Brooks, "we're going to do the Bermuda Race again. We did it once, but we weren't satisfied with our finish."

Other races that *Dorade* won in her youth, and that Brooks plans to do again, are the TransAtlantic Race and England's classic Fastnet Race.

What a terrific and unusual program for a yacht that hadn't been raced competitively since the 1930s.

— richard



SHARON GREEN / WWW.ULTIMATESAILING.COM

'Dorade' — see Letters for the correct pronunciation — at the finish of the 2013 TransPac.

ha-ha'ers converge on san diego

As regular readers know, October is the month when our annual Baja Ha-Ha rally sets out from San Diego — on the 28th this year — bound for the sun-kissed waters of Cabo San Lucas. As you'll learn if you peruse the fleet list (www.baja-haha.com) or check out the Ha-Ha mini-profiles on page 108, rally participants don't all come from the Bay Area, or even from California. As in years past, many hail from Oregon, Washington and British Columbia, and this year a few boats have homeports as far away as Quebec, the U.S. Virgin Islands, Great Britain, Sweden and Austria.

Two entries we think deserve special mention here are Jim and Kent Milski of the Lake City, CO-based Schionning 49 *Sea Level*, and Marty and Sue McDaniell of the Coupeville, WA-based Jeanneau 43 *Happy Dance*. Why? Because they've both had unusual adventures on their way to the starting line of Baja Ha-Ha #20 — aka the Platinum Ha-Ha.

In May, the the Milskis completed a three-year westabout circumnavigation from Zihua to Zihua. Not only was it an unusually fast trip around the planet — for cruisers, anyway — but they experienced some hair-raising challenges along the way which they detailed in our August edition interview. Having sailed all that way, you might wonder why they'd want to do the Ha-Ha again (they're vets of the 2008 event). The answer is simple. It's a boatload of fun, and they'll be sailing south in the company of many previous cruising buddies.

Although the McDaniells are based in the San Juan Islands, they toured the Alaskan coast for much of the summer, and were blessed by fine weather and northerly winds — until they decided to head south. After enduring more than a week of rain in Ketchikan, they finally saw a break in the weather along the B.C. coast. But before they could get to it, they had to cross Dixon Entrance, Hecate Strait and

continued on outside column of next sightings page

SIGHTINGS

ha-ha — cont'd

Queen Charlotte Sound. As Sue explains, "Three rather inhospitable bodies of water." Nevertheless, they stoked up their afterburners and motorsailed south into a 15- to 20-knot southerly. When the winds finally clocked north again they were too weak to keep the sails full, so the couple ended up motoring or motorsailing the entire way — 168.7 hours with only three short pit stops for more diesel.

"The biggest scares had to do with traveling blind in the fog," recalls Sue. "We have radar, but there were times when the fog was

so thick and the seas so glassy that it was difficult to determine between real targets and radar scatter." At one point a 25- to 30-ft powerboat — which hadn't shown up on radar — appeared out of the fog heading right at *Happy Dance*. With quick maneuvers they managed to avoid it.

Fortunately, the high points outweighed the lows. "For a few nights we enjoyed watching the full moon leading

us down a silver pathway. And then seeing the sunrise while the moon set — what a sight! Being offshore and seeing the sun sink into the sea is a magical thing."

Eight days and 1,253 miles after leaving Ketchikan, the McDaniels passed beneath the Golden Gate with ear-to-ear grins. "We were just so happy to be there that it didn't matter that we never even saw the Bridge due to the fog!"

The Milskis, the McDanielses and roughly 550 other sailors will converge on San Diego Harbor in the coming days from many ports of call. If you're in that area on Monday, October 28, we invite you to bid *bon voyage* to the 161-boat fleet as it parades out of the harbor at 10 a.m. en route to the Baja Ha-Ha starting line off Point Loma. Look for a complete recap of BHH 2013 in the December edition.

— andy

arson attempt at city yachts

Chris and Sarah Kaplan of City Yachts had a nasty surprise waiting for them when they arrived at their Gashouse Cove brokerage and fuel dock around 8 a.m. on September 11. Someone had stacked a bunch of jerry jugs into a pyramid next to their office and apparently attempted to set a fire. Thankfully the fuel the would-be arsonist tried to ignite was diesel so, while it heated up enough to char the teak bench next to the office and melt a couple of jugs, there was no other damage.

A quick review of their security camera's recordings showed a man jumping their security fence just an hour earlier. Their first calls were to the authorities, then they contacted *Latitude* so we could put out an alert to Cityfront marine businesses to be on the lookout. "We don't know what his motives were," Sarah said, "but I wanted to get the word out to marinas and businesses around the Cityfront that he wasn't afraid to do this in broad daylight."

Sarah called back the next day to report the suspect — Andrew Glenn Rice — had been arrested. According to the San Francisco Police Department, they received a tip that morning regarding his where-

continued on outside column of next sightings page

boating fund

As predicted would happen when the Department of Parks and Recreation absorbed the Department of Boating and Waterways last year, California state lawmakers tried to raid the Harbor and Watercraft Revolving Fund for non-boating uses. The Recreational Boaters of California and BoatUS joined forces last week to alert boaters about this last-minute money grab and their lobbying paid off, sort of.

California Senate Bill 436 passed in

COURTESY HAPPY DANCE



Sue and Marty McDaniel motorsailed in an impressive 1,253 miles in eight days on their Jeanneau 43 'Happy Dance'.

While many boats entered in the Baja Ha-Ha XX are first-timers, Jim and Kent Milski just completed a three-year circumnavigation on their Schionning 49 'Sea Level'.



nearly raided

the final hours of the state legislature's 2012-2013 session, but a key portion that would have opened up the HWRF for non-boating purposes — setting a troubling precedent — was dropped. Instead, the bill allows for the possibility of "a grant or loan of \$1 million from the HWRF to Port Hueneme for emergency measures to prevent damage to streets and property along Hueneme Beach caused by beach erosion and flooding."

— *ladonna*

arson — cont'd

abouts, and he was taken into custody. The 48-year-old San Francisco resident was charged with arson, possession of a combustible substance with willful and malicious intent to use, and trespassing. He pleaded not guilty and is being held on \$100,000 bail.

Police have yet to supply a possible motive, but it appears Rice has no connection with City Yachts. So the questions remains, if Rice set the fire, why? Was it a 9/11 memorial plot? Did he have a beef with the America's Cup? Was he just trying to get his jollies? We may never know the full story, but one thing we do know is that if the jerry jug that was set on fire had been filled with gas instead of diesel, you would be reading a very different story right now.

— *ladonna*



SPREAD COURTESY SEA LEVEL

SIGHTINGS

another kind of cup

Everyone's heard of the America's Cup, and Bay Area racers have been enjoying the Jazz Cup for 25 years — you'll read more about those events elsewhere in this issue. But, unless they're from Redwood City, not too many sailors have heard of the Hannig Cup.

Ted Hannig relates the 2005 origins of the big South Bay fundraiser that bears his name: "Our youth needed better boats. For my birthday, I invited people who might give me a present to donate to this instead."

continued on outside column of next sightings page

short

SAN JUAN ISLANDS — On September 13, a ferry sailing from Lopez Island to Orcas struck the 28-ft sailboat *Norma Rae*. The solo sailor aboard, a man in his mid-60s, was uninjured but the same couldn't be said for his poor boat, which was dismasted and then sank under tow. Witnesses say the day was clear at the time of the accident, and that the sailboat

The Open 5.70 'Boudicca' was one of the later starters of Sequoia YC's Hannig Cup pursuit race.



SPREAD: LATTITUDE / CHRIS; INSET: J. ENNIS KIRKLAND

sightings

was under power with no one at the helm. The Coasties are investigating.

SAN JUAN ISLANDS — A week later, on September 20, the 30-ft *Beaujoulais* ran aground on the northeast shore of Obstruction Island. The father and son aboard were not familiar with the area, and were moving after dark. They hoped

continued in middle column of next sightings page

hannig — cont'd

The annual Hannig Cup is sailed in conjunction with Sequoia YC's Wednesday night beer can series, a weekly pursuit race out of the Port of Redwood City. They have a trophy for the winning boat, and also for the boat that raises the most money for the various nonprofits the event supports. Alex and Penelope Huang's *Islander 44 Odyssey* won that honor this year on August 28 by raising \$8,000.

The race winner was an unlikely prospect. The *Santana 22 Cypress* started the evening by sailing out of its slip (there was no engine onboard) and promptly running aground in the harbor, much to the amusement of onlookers. The crew pushed off the mud with the whisker pole and started the pursuit race as the scratch boat.

"They started yesterday," joked Rear Commodore Dan Lockwood.

Actually, they started at 5:30 p.m. and beat the other 53 boats on a course that was shorter than usual, to get everyone back to the club in a timely manner for a big dinner party and presentation.

"*Cypress* is a club boat," said crew member Patricia Corcoran, "and she does not always feel like a debutante. So, I asked Tom Keegan and Olivia Sadlowski to help me dress *Cypress* up for her debut at the Hannig Cup. Even after running aground trying to get out of the marina, we finished first! The flowers, leis, streamers and champagne all helped *Cypress* feel very special."

Just in case the short race wasn't exciting enough, fleet captain Rick Dalton announced that a ship would be departing the port at 6:30, at the same time as the bulk of the sailboats.

Dalton was chatting with Bar Pilot X-Ray on the race channel, allowing the entire fleet to hear the pilot quip, "I don't want to take any souvenirs." The ship turned a surprisingly tight circle to dock out. "They stayed on their side and we stayed on ours," said Dalton.

Back at the club, Sea Scouts served up a buffet dinner, itself a fundraiser, and Ted Hannig presented ceremonial checks to many recipient organizations. Redwood City mayor Alicia Gary accepted one on behalf of a foundation of charities, including a scholarship for youths with cancer, the Sea Scouts, Guide Dogs for youngsters, and the Boys & Girls Club. "A number of youth sailing organizations, including the Peninsula Youth Sailing Foundation and the Sequoia Junior Sailing Program, benefit from this event," said SeqYC's Tim Petersen.

"This is all grassroots," commented Hannig. "Just boaters giving back, particularly to younger people, in recognition that most of us got some help along the way and now it's our turn to give back." This year, friends of Ted made a spectacular donation — \$829,500 — to help build a Floating Clinic to be based at Bocas del Toro, Panama. A pretty swell birthday party!

— chris

eight bells for a multihull pioneer

The dazzling performance of ultra-fast AC72 catamarans during America's Cup 34 made converts of many former skeptics who'd dismissed them as dangerous aberrations. It's a shame Dick Newick couldn't be there to see it. An early pioneer of multihull design, he passed away in Sebastopol on August 28 at the age of 87.

"Like most art that reconfigured the future," wrote Steve Callahan

continued on outside column of next sightings page



Ted Hannig presents PYSF director and head coach Molly Vandemoer, and Andrew and Kyle with a \$75,000 check for their sailing program.



newick — cont'd

in an excellent Newick retrospective in 2010, "designer Richard 'Dick' Newick's creations threatened some as much as they enlightened others. At times, his trimarans' simplicity, structural reliability,

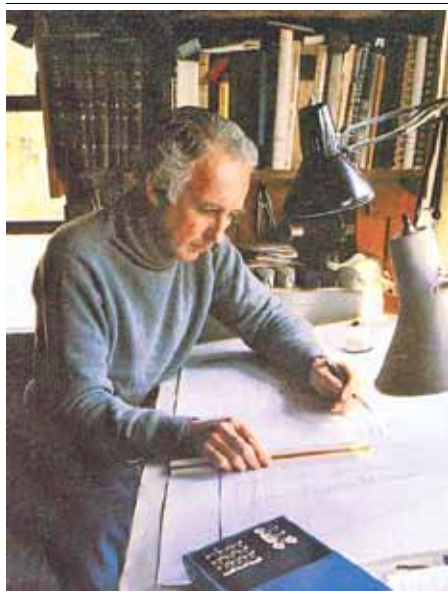

Dick Newick at work at his design table.

and astounding speed seemed like grenades tossed into yacht clubs."

Today, in an era when multihulls are not only winning the America's Cup, setting around-the-world records, and dominating the bareboat charter industry, it's amazing to think that just a few decades ago cats and trimarans were regarded as blasphemous, and those who designed and sailed them were disparaged by epithets such as "the Hell's Angels of the sea," as noted in a *New York Times* obit.

Such monikers probably didn't bother Newick in the least. When he became interested in multihulls in the late 1950s and early '60s he knew his revolutionary ideas would upset the stodgy status quo of the blue blazer set, but his innovative vision eventu-

ally won over many disbelievers. One of the most notable showcases for Newick's designs was the OSTAR transatlantic race. In 1968 his 40-ft (Polynesian-inspired) proa *Cheers* took third against many larger boats. Other Newick designs made headlines later in the same race, most notably the 50-ft *Moxie*, in which Phil Weld — then 65 — annihilated the OSTAR record in 1980.

Dick continued to design into his eighties, never losing his thirst for innovation. Beginning with his earliest multihull designs 50 years ago, the lines of his creations were gracefully aerodynamic, often inspiring reviewers to compare their elegant forms to birds in flight. As we assess the potential impact of AC 34 on future sailboat races, it's worth remembering that we might never have reached such a benchmark of innovation without the vision and determination of 'rebellious' multihull pioneers like Dick Newick.

— andy

experienced journalist wanted

After more than seven years of being a fabulous member of *Latitude 38's* editorial team, LaDonna Bubak — not to be confused with Doña de Mallorca — is leaving *Latitude* at the end of the year to do what you'd expect: go cruising with her husband Rob on their Wauquiez 47 *Gazelle*. We are really going to miss her for so many reasons.

That means we're actively searching for a passionate and productive in-house journalist to fill her shoes. The position involves writing, editing, proofreading, photography and layout — and being able to do three or more of them at once while under the pressure of an inflexible deadline. The material could be anything from local sailing features to racing to cruising — whatever it takes. And the job requires contributions to the three-days-a-week *Lectronic Latitude*. If you're looking for a super-casual and cushy job, this isn't it. If you're looking for a telecommuting position, this isn't it. If you're looking for a job in which you work 9 to 5, this isn't it. But for the motivated journalist, it can be extremely rewarding.

Latitude's World Headquarters are housed in an old building in

continued on outside column of next sightings page

shorts

the boat would refloat at the next high tide but it instead filled with water. The Coasties ordered the pair off the boat, and they were forced to watch the uninsured boat sink. They now must arrange for the boat's removal.

CAPE COD — On September 2, the Coasties seized nearly 1,400 lbs of cocaine valued at over \$20 million from the 49-ft sailboat *Callista* about 400 miles east of Cape Cod. A Canadian and



This photo spread of the *Voiles de St. Tropez*, which runs through October 6, is for all the luddites out there who are sick to death of the uber-high-tech America's Cup. For more drool-worthy photos, go to www.lesvoilesdesaint-tropez.fr/en.

— cont'd

a Spaniard were arrested. Authorities believe the boat was bound for Montreal.

PALOS VERDES — Ian and Jo Jory were on their way home from Catalina Island on September 2 when a whale bumped into their 31-ft sailboat. "It lifted the left side of the boat 4-6 feet out of the water," Ian said. The boat was able to make it to a yard but it has cracks in the hull and separated bulkheads.

— *ladonna*

job — cont'd

leafy Mill Valley, and most of our staff have been with us 15 years or more. Everybody knows their responsibilities, so we don't micro-manage — we just expect you to do whatever it takes to get the job done well and on time. We pay competitive wages and foot the bill for 100% of the health insurance coverage with Kaiser. And from time to time there can also be some great travel opportunities.

We welcome resumes from anyone local who meets our minimum requirements. **NO PHONE CALLS!** Anyone who calls is automatically disqualified. Go to www.latitude38.com/jobs/jobs.html to read the complete job description, and to send us your resume and writing samples.



PHOTOS CARLO BORLENGHI / ROLEX

SIGHTINGS

all is lost is coming soon

Buzz has been building in the sailing community about Robert Redford's one-man-show *All Is Lost*. Directed by J.C. Chandler and having debuted at the Cannes Film Festival, the film follows a single-handed sailor — played by Redford — after his Cal 39 is holed by a shipping container in the Indian Ocean.

Critics and filmgoers alike have given Redford rave reviews for his "tour de force" performance in which he barely speaks — he is alone, after all — but everyone on the docks wonders how accurately the sailing and liferaft scenes are.

continued on outside column of next sightings page

BEFORE THE DOOR PICTURES

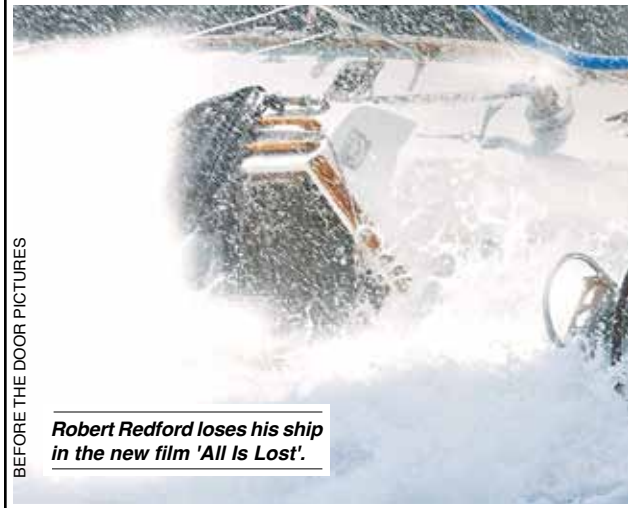

Robert Redford loses his ship in the new film 'All Is Lost'.

This Fisher's Island 44 motorsailer may not be the sexiest hull design you've ever seen, but she got Brian Black and his family safely around a 7,000-mile South Pacific circuit without benefit of any modern-day gizmos and gadgets.



PHOTOS COURTESY JOHN BLACK

all is lost — cont'd

We all remember the scene in *Dead Calm* where waifish Nicole Kidman sails at full speed toward her husband stranded on a wooden raft. As she approaches, she leans over the toerail, arm outstretched, and just manages to grasp his wrist and pull him aboard. Pheww! *[Insert eyeroll.]*

Thankfully, the trailer for the *All Is Lost* looks pretty thrilling, so we're optimistic that we'll be entertained by what the director calls "an existential action movie."

The film will be featured at the Mill Valley Film Festival on October 12 and 13, with showings in Mill Valley and San Rafael. See www.mvff.com for tickets (if they haven't sold out), or wait till October 18, when it will be released nationwide.

If you see the film, we'd love to hear what you thought about it. Send your short reviews to editorial@latitude38.com.

— ladonna

coming full circle in the marquesas

For most sailors, making landfall in the shadow of the Marquesas' craggy, primeval mountains is the fulfillment of a longtime dream. But for Brian Black of the Alameda-based Caliber 40 *Alegria* it was that and more. By stepping ashore at Hiva Oa, he'd come full circle, as he'd visited that remote island in 1964 when he was only 14, and had always dreamed of returning.

The Fisher's Island 44 motorsailer that he and his family sailed during that eight-month South Pacific circuit was also named *Alegria*, but with its boxy salon it was pretty funky by today's standards. "Google it," wrote Brian. "It'll scare you to death."

Nevertheless it got him, his 12-year-old brother, his father and his stepmother to dreamy places like the bay of Hana Menu. Although that was 49 years ago, Brian still vividly remembers the friendly family they

met there: "A mother, father and son. They were very kind to us, and fixed us a wonderful lunch."

So when Brian returned to Hiva Oa last spring, he asked a woman he met named Marie Jo about Hana Menu. "She said her husband John had lived in Hana Menu at about that time. Back at the boat, I printed out a copy of a photo of the family we'd met at Hana Menu from the earlier trip. When I met Marie Jo's husband John the next day, he looked at the photo for a while and recognized his father, mother and himself. He said he had no photos of his father until his father was 60, so this one was very nice. We took a tour of the island with John and got him a few more copies of the photo, and he fixed us a marvelous lunch.

"Marie Jo and John are wonderful," says Brian, who did the Pacific Puddle Jump this year with Mizzy Lewis. "They provide cruiser's services in the bay, near Atuona. Hail Marie Jo on VHF Channel 11." And tell her *Alegria* sent you.

— andy



L to r, John's mother, John, his father, Brian's stepmom Jerry, and a Swedish singlehander named Paul, whose classic cruiser was the only other boat in the bay.

SIGHTINGS

a circumnavigation of a different kind

And now, for a circumnavigation that's a tad unusual in several respects.

First, the 'circumnavigators' — Ed Kelly, 67, and his wife Susan, 65, periodic contributors to *Latitude* — hail from Des Moines, Iowa, which is not exactly a hotbed of folks who adventure internationally on sailboats.

Second, they did it aboard their humble Catalac 12 Meter catamaran *Angel Louise*, which was already 20 years old when they



Susan and Ed Kelly just finished an unusual circumnavigation.

purchased her upon their retirement in 2007. Despite being a somewhat dated design, she's already taken the couple to 44 countries on five continents in safety.

Lastly, a large portion of the trip was done under power. That's because the couple's circumnavigation was of Europe — at least as much of it as could be done using the international rivers and waters

connecting the North Sea with the Black Sea, other major seas, and the Atlantic Ocean. It's true that in the course of the trip both of the catamaran's aged and tired diesels had to be replaced, but you do what you have to do.

The Kellys started and ended what turned out to be a 494-day adventure of 6,200 miles at St. Katherine's Dock in London. Their 'voyage' took them to the following countries: England, Netherlands, Germany, Austria, Slovakia, Hungary, Croatia, Serbia, Bulgaria, Romania, Turkey, Greece, Italy, Malta, Tunisia, Spain, Gibraltar, Morocco, Portugal, France, and the Bailiwick of Guernsey (Channel Islands). In the process of the trip, they would need the help of 74 major locks, collectively taking them as high as 1,344 feet above sea level in order to cross Europe's continental divide. Naturally, *Angel Louise's* mast was on deck from the North Sea to the Black Sea.

The Kellys believe they are the first Americans to complete such a circumnavigation. It should be noted that Jack van Ommen of the Gig Harbor, Washington-based *Naja 30 Fleetwood*, did a somewhat similar trip a couple of years before — as recounted in *Latitude* — except when he got to the Med on the clockwise way around, he returned to Holland, where he'd begun, via the rivers and canals of France and the Netherlands. The Kellys made their way back to their London starting point via the Atlantic Ocean, arriving on September 16.

Ed said many of the difficulties in the journey were diplomatic, as they had to pass through and among 20 countries where many different languages were spoken. Although the locks on the Danube River were international, many of the officials did not speak English, so communication could be tricky. Additionally, each country outside the Schengen Area required entry and exit stamps. In the Schengen Area, which now encompasses 26 European countries, Americans and most foreign boaters are legally allowed to be present for only 90 total days in any six months. The Schengen Agreement relaxed the crossing of borders, but customs officials at each country still stopped and examined the boat and her papers.

"It has been a singular joy meeting people of goodwill everywhere we traveled," said Sue, who nonetheless noted that an undercurrent

continued on outside column of next sightings page

san francisco

There's a new boat show in town! Last month, the National Marine Manufacturers Association announced the dates for the inaugural Progressive Insurance San Francisco Boat Show, January 23-26 at McCovey Cove and Pier 48. With a capacity for more than 100 boats in the water and dozens of onshore exhibits, this could turn out to be an impressive show, as long as the weather cooperates.

The show will feature a mix of new and brokerage boats, both power and



The Kellys were met with nothing but friendly faces during their voyage.

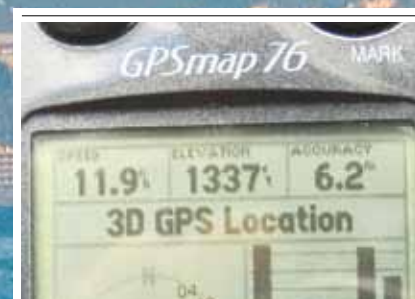

The highest elevation the Kellys saw on their European circumnavigation.

boat show

sail, along with educational seminars and workshops. The NMMA has partnered with Sail America to "produce a strong Sail Fest within the show, featuring sailing seminars, hands-on demos and fun family attractions," notes the press release.

We do wonder about the dates, though, which aren't ideal for an outdoor show. They also conflict with the Seattle Boat Show, and we know a number of people who would love to attend both.

— *ladonna*

circumnavigation — cont'd

of distrust ran deep in many of the places they visited. It manifested itself when some local citizen who befriended them would take them aside to warn them to be very careful of the citizens at their next destination on their journey. The warning was often in the same tone folks in the country before had given them about the people who were now helping them, and who were warning them about the folks in the next country.

"No matter where we landed, we found only friendly faces," said Ed.

Prior to their European adventure, the Kellys had cruised *Angel Louise* to and through the Caribbean, and across that Atlantic to England.

— *richard*



Much of the trip was spent under motor, below, or with the mast unstepped and secured on deck.



ALL PHOTOS COURTESY ANGEL LOUISE

AMERICA'S CUP 34 —

There is a new gold standard at the highest level of yacht racing. It's AC72s on San Francisco Bay. Like the America's Cup itself, there is no second place. The transformation brought about by the creation of the AC72s has been no less than that of biplanes to passenger jets, Model Ts to F1 cars, or snail mail to high-speed Internet. Since this sailing show of a lifetime happened on our home waters, we hope you didn't miss it.

Having already made an improbably spectacular comeback from an 8-to-1 deficit in the improbably exciting 34th America's Cup on San Francisco Bay, Oracle Team USA came from behind in the 19th and final race to defeat Emirates Team New Zealand and retain the oldest trophy — 162 years — in sport.

The thrilling comeback was one for the ages, and not just in yacht racing.

As a result, the Cup received unprecedented mainstream media coverage and made converts of many who had previously been indifferent if not outright hostile to yacht racing. So many enthusiastic new fans — most of them non-sailors — rushed down to the Cup Village to watch the final race that the Fire Marshall had to turn thousands away.

The last race was a stomach-churning nail-biter for 2¼ legs, but the final result

Crosses and curves, nobody realized what great match racing boats the AC72s could be — but only with superb crews.

didn't come as a complete shock. After falling behind by seven races, OTUSA was on a roll, having roared back to an 8-to-8 tie.

But there was more to it than that.

Kiwi head Grant Dalton said he'd "slept the best I have in a week" because he was confident that he knew what the outcome was going to be — although it wasn't going to be good.

The final victory was not a case of the Kiwis faltering, but rather of Oracle having continued to hone some combination of the various aspects of their effort. First, having been taught how to

tack and jibe by the Kiwis in the early races, Oracle had gotten up to par. Second, Oracle's replacement tactical team — a triumvirate of Ben Ainslie, Tom Slingsby and helmsman Jimmy Spithill — were making nearly flawless decisions, even when they took gambles. They were helped by no longer having the slower boat.

But most of all, the victory was due to what Larry Ellison said was the Oracle team engineers "breaking the code." The AC72s are formula boats, which means they could be modified throughout the regatta. Oracle had made more than a dozen modifications.

Ellison refused to specify what modifications he meant by "breaking the code," and later hedged the importance of the modifications by saying, "Our VMG was faster with the bow down," indicating that improved sailing technique had also helped.

Kiwi commentators speculated about an automatic stability augmentation system that supposedly helped balance Oracle when foiling upwind. The Kiwi boat had a similar system, but it was manually operated.

While the changes made are un-



ABNER KINGMAN / ACEA

"When you're staring down the barrel of a gun, you can either get wobbly in the knees or smile." So says Oracle helmsman Jimmy Spithill who smiled when behind 1 to 8. He's 'Latitude's MVP of America's Cup 34.

clear, the result was not. "The obvious difference was Oracle's ability to foil upwind," said Kiwi helmsman Dean Barker. "Oracle's boat systems or [sailing] technique were better suited for foiling upwind for sustained periods."

Dalton said that by the end of the Cup, Oracle had made a 90-second improvement between the two boats on the weather legs. "A huge difference."

Having achieved effective upwind foiling capability in time for the last two races was like the U.S. getting the atomic



GILLES MARTIN-RAGET / ACEA

THE GREATEST EVER

bomb to end World War II. As a result, the two last races were near spitting images of each other. The Kiwis won both the thrilling starts, maintained a slight advantage during the high-speed run down to the leeward mark. Then came the upwind 'leg of truth'.

During the first of the two races, there was a thrilling moment when the boats were side by side at the same speed heading for the boundary near the cone of Alcatraz. Suddenly Oracle got up on her foils and, as if turning on turbochargers, took off. This allowed Oracle to build a substantial lead to the weather mark — just as the Kiwis had been able to do to them in the early races — and

maintain it on the run to the second leeward mark and reach to the finish. There was only a slight variation to this in the

*"I'm biased toward Auckland, but I can't think of a better place to race than San Francisco Bay."
— Grant Dalton*

second of the last two races, completing the unprecedented comeback and retaining the Cup for Oracle Team USA.

When Oracle crossed the finish line for the last time, it was much to the delight

of many thousands of flag-waving Oracle fans — most of them newly minted — lining the San Francisco waterfront. Most of the vocal but ever-friendly Kiwi fans were already back in New Zealand, as the event was supposed to have ended three days before. Two days of excessive winds and one day of insufficient wind had forced the event to be extended.

During the press conference after the Cup, Spithill and other Oracle team members praised their Kiwi opponents. As well they should, for the Kiwis had given them the battle of a lifetime, and

Throughout the 19-race Cup series, there were plenty of ups and downs. Oracle started the series way down low and a little slow.



AMERICA'S CUP 34 —

had been magnanimous in the early going when it looked as if they would pound Oracle by 9 to 1.

Ellison saluted Kiwi skipper Dean Barker in particular. "No one should have the weight of a nation on his shoulders like Dean Barker did." But it had been on his shoulders. The ratings for the Kiwi television broadcasts had been the highest ever. And when it was over, Dalton noted that, "The country is devastated."



RICARDO PINTO / ACEA

"We'll try our best," said Dean Barker before the start of the last race, which was code for "We're screwed." And they were, largely by Oracle's new-found ability to foil to weather.

Added to the pressure was the fact that the Kiwi government, which had chipped in \$25 million, made it clear that if the Kiwi team didn't bring the Cup home, they wouldn't get any government money for future America's Cups.

The post-race press conference was Ellison's first public Cup-related appearance in some time, and he was charming. When asked if Russell Coutts' job with the Oracle team had really been in jeopardy — as had been widely rumored — if Oracle had lost, Ellison laughed. "Russell Coutts is the leader of this team. He's won more America's Cups than anyone, and it's his job as long as he wants it.

There were a lot of great viewing options, but oddly enough most of them were from on land — unless you had a big screen HD on your boat.



GILLES MARTIN-RAGET / ACEA

We're blessed to have him."

Ellison said Coutts' contributions, included saying, "It didn't make any sense," that the Kiwis were faster upwind when they were leading 8-1. In another example, Ellison pointed out that Coutts had repeatedly advised Spithill to drive lower and faster instead of higher and slower — the latter a common multihull driving mistake. Spithill threw his head back in laughter of acknowledgment.

Spithill, whose resolute confidence at the darkest moments had saved the day more than once for Oracle, and who relentlessly spoke of OTUSA being a team effort, echoed Ellison's description of the seldom-seen Coutts as being "the team's leader."

Classy sportsmen that the Kiwis are, Barker and his defeated mates praised the Oracle effort. Barker, in his normal soft voice and subdued tone, noted that it was difficult to accept defeat after victory had been so tantalizingly close for so long.

How close? In the light-air 13th race,

*"You know what 8 to 1 is? It's motivation."
— Jimmy Spithill*

*"I'll get behind that."
— Larry Ellison*

they were a ridiculous 1,200 meters ahead of Oracle with just a mile to the finish when the race was called off on account of the 40-minute time limit. Had the race lasted just another few minutes, the Cup would now be on tour through the cities, towns and villages of New Zealand.

In this America's Cup, Lady Luck decided it was just as easy to fall in love with the billionaire's trailing team as with the guys in the lead who didn't know where their next-generation daggerboards were going to come from.

For example, race nine was called because of excessive wind. At the time, the Kiwis were leading Oracle at the



RICARDO PINTO / ACEA

leeward mark, about to start the weather leg, where at that stage in the Cup they absolutely owned Oracle. And the Kiwis were leading at the start of race 12, but seconds later it was called for excessive wind. The Kiwis didn't whine about having had bad luck, but that had been the case.

There was a trace of bitterness from Kiwi leader and frequent crewmember Dalton, who not only looked very tired from putting his 56-year-old body through races that were far more physically demanding than in any previous Cup, but he was also mentally weary from the Coutts/Ellison incarnation of the Cup.

Dalton stated that the Kiwis — whose country has a smaller population than that of the Bay Area — needed to spend \$100 million to try to be competitive. He made no secret that he thought the sum was absurd, and that it had limited the number of challengers.

When a reporter asked if Dalton thought Oracle had outspent the Kiwis, Dalton responded by asking if he really needed to answer such a silly question. When Ellison was later asked if he'd spent more than \$100 million, he side-stepped the question with a smile.

More than a few Kiwis believe that Oracle retained the Cup because of the

THE GREATEST EVER



Spread: Oracle's cat may have been 72 feet long, but when foiling she had a 4-foot waterline. **Inset:** These boats are for athletes only.

Second Golden Rule: He with the most gold, rules. Their belief is that Ellison's limitless wealth allowed Oracle to have a bigger and better-equipped team of engineers and shore crew, many of whom worked through most nights of the Cup to improve the boat.

There is almost certainly some truth to this belief. Oracle made at least 15 modifications to their cat during the Cup, while the Kiwis, despite spending \$100 million, made only about half that many. To non-sailors, small changes to such big boats may seem as if they couldn't make a significant difference, but they can. This is particularly true when often the only parts of the cats in the water are the boards and the rudders. And when boat formulas are new, there is the opportunity to make big gains. When Kiwi Glenn Ashby was asked to describe the 'learning curve' on the AC72s he responded by pointing his hand straight up.

By the end of the Cup, both boats were sailing significantly faster than at the beginning, even when in the same conditions. Dalton said by the end of the Cup their lowest speed in the middle of tacks was 14 knots, up from 10 knots.

"We always knew this was going to be a tech competition," said Dalton,

"It's been too expensive, but Oracle did a great job on the technology."

As long as the America's Cup is a 'design competition', the team with the most bucks is going to have a big advantage. That's why we at *Latitude* have always been in favor of one-designs, the America's Cup Deed of Gift notwithstanding. We want the best sailors to win the America's Cup, not necessarily the best-funded team.

There were so many races it's impossible to remember them all, so we'll take you back to remind you about the details of some of them, and how many times Oracle had been on the ropes before making their miracle comeback.

Race 1. The Kiwis won the start of this hugely anticipated race, and riding strong winds, led Oracle at the leeward mark by only four seconds. The US team overtook the Kiwis early in the windward

leg, then the Kiwis grabbed the lead back, and held on to win by 36 seconds. Excitement Level: 10.

"I'd hazard a guess that today's opening race was the best racing ever seen in the 162 years of the America's Cup," wrote Dana Johannsen of the *New Zealand Herald*, which covered the event in more detail than any other publication.

Race 2. The Kiwis won the start for the second time in strong winds, but Oracle was right on their heels at the leeward mark. But again, the Kiwis demonstrated superior acceleration out of tacks, and went on to win by 52 seconds. EL: 8.

Race 3. The always-aggressive James Spithill won the start for Oracle and led at the leeward mark by 18 seconds. But in a disturbing trend, the Kiwis were again better at tacking and sailing upwind. They won by 28 seconds. EL: 9.

Oracle's mediocre crew work and poor upwind performance were a mystery. After all, they were the only team that ever had two boats available at once for two-boat testing, which should have been a huge advantage.

Race 4. Oracle led at the reaching mark by six seconds, and was pressed to the hilt the entire way by the pursuing Kiwis. Nonetheless, Oracle held on to win by just eight seconds. The most exciting America's Cup by far had just gotten more exciting than anyone had believed possible. EL: 10+++.

Race 5. With the 'mo' from the win in the previous race, Oracle's hopes were high and they led at the leeward mark by 18 seconds. But after a flubbed tack and poor tactics, the Kiwis seized the lead, then proceeded to whip Oracle on

There were lots of Kiwis — and Americans — rooting for New Zealand. Oracle's Larry Ellison said he didn't take it personally.



the upwind leg by a humiliating 90 seconds. The 1:05 margin of victory was the largest to date. EL at the leeward mark: 10+++ . EL at the top of the windward leg: 2.

Oracle was so devastated, they played their only 'postponement card'. They admitted there was nothing wrong with their boat, but that they just needed to regroup.

Race 6. Four-time Olympic gold medalist Ben Ainslie came aboard as tactician for Oracle, and for the first time winds weren't near the limit. Oracle won the start and finished the downwind leg 12 seconds in the lead. It was as thrilling as racing could be, but every Oracle fan feared another massacre by the Kiwis on the upwind leg. Those fears were well founded, as the Kiwis gained a massive 55 seconds, and walked away. EL: 10++++ until the middle of the weather leg.

Race 7. The Kiwis led start to finish to win easily by 1:06, the biggest margin yet. Oracle was now down 6 races to 1 on the water, and 6 races to -1 on the scoreboard. Fans wondered if Oracle could even have beaten the hapless Luna Rossa Italian team. EL: 6.

Race 8. The tide began to turn. Oracle, having made undisclosed modifications to their boat, and having learned to tack like the Kiwis, showed better speed upwind. With the boats neck and neck two-thirds of the way up the windward leg, the Kiwis were forced to tack quickly, but lacked the hydraulic power — which is created by grinders grinding — at the critical time. Their wing stayed cocked to

The 34th America's Cup was wetter and wilder than any predecessor. And it was much harder on the grinders than ever before.



windward, so their windward hull rose precariously high into the air, and they came within half a degree of flipping. Thankfully the boat righted herself, but Oracle romped off to win big. The near flip was the wildest single moment in the history of the America's Cup, and somewhat overshadowed what a brilliant match race it had been. EL: 10+++.

Race 9. The Kiwis, who should have been rattled by the near flip an hour before, dominated the first two legs of the race — which was then called off as the wind exceeded the allowable 22.6-knot limit for the day. Spithill told the press the same old story, that Oracle was making improvements each day and could still win. Nobody believed him.

Race 10. With the Kiwis needing just two wins, Oracle sailed a superb race. They overtook the Kiwis on the windward leg, after which the lead changed three more times on that leg alone. Oracle had a one-second lead at the beginning of the downwind leg, but in a high-speed downwind crossing situation Oracle had to duck the Kiwis. In a blink of an eye they lost 100 yards and, by 17 seconds,

Team New Zealand nearly flipped out during a fast tack in the eighth race, which would have prematurely ended the competition.

the race. "If you didn't enjoy today's race, you should probably watch another sport," said Dean Barker. EL: 10++++. It had been the best America's Cup race ever.

Race 11. Kiwis won by just 15 seconds, with the improving Oracle right on their tails. Could the America's Cup racing get any better than this? The boats and crews were now evenly matched, but it was match point for the Kiwis while Oracle needed to win an impossible eight straight races. EL: 10++++.

Race 12. Spithill won the start and the race wire-to-wire by 31 seconds. Oracle hit 32 knots foiling upwind. EL: 10+++ . This match racing was not to be missed.

Race 13. The Kiwis totally dominated Oracle in a mere eight knots of breeze, but the time limit expired before they could grab the Cup and fly home to New Zealand. The Kiwis still held a big lead, so there were not too many worries. EL : 2.



THE GREATEST EVER



GILLES MARTIN-RAGET / ACEA

tinue? EL: 10++

Race 17. Oracle was behind by two on the scoreboard because of World Series shenanigans, but on the water the score was 8 to 8. Spithill put two penalties on the Kiwis at the start, then dashed off to an easy win. EL: 10++++ New Zealand began self-medicating.

Race 18. For the first time in a long time, Barker and the Kiwis won the start and took a slight lead on the downwind leg and around the leeward mark. The crucial point in the race — and perhaps the Cup — was when the Kiwis tacked below a trailing Oracle to try to maintain their lead on the upwind leg. It was absolute nip-and-tuck, and then Oracle got up on foils to weather to take over the lead. From there they built a big lead, and the Kiwis looked badly shaken. It had become Oracle's Cup to lose. EL: 10++++

Race 19. The Kiwis won the start and the first two legs, but the race and the Cup competition were decided on the windward leg, as Oracle again foiled to weather to take a big lead and waltz to victory. EL: 10

Skeptics believed Ellison had made some deal with the devil to keep the Kiwis from finishing. As evidence, they pointed to the fact that Ellison announced he was taking \$78 million less in annual compensation from Oracle Software. "The devil made him do it," said the skeptics.

Race 13, resail. The races kept getting more thrilling as, facing elimination, Oracle was fouled by the Kiwis in a high-speed downwind crossing situation. Wow! The Kiwis then messed up their jibes just before the leeward mark, allowing Oracle to win by 1:24, the biggest margin of the Cup. EL: 10+++ Oracle was still down 8 to 3 on the scoreboard.

Race 14. Now in the third week, the longest America's Cup in history, the tide began to swing in Oracle's favor. In a start-to-finish thriller, Oracle prevailed, continuing to show improvement. EL: 10.

Race 15. After a super-close start, Oracle took the lead and held off several Kiwi attacks to take the race by 23 seconds. Four million Kiwis took a deep breath. EL: 10++.

Race 16. Oracle won her fifth race in a row. How long could the streak con-

than Ellison would give the important presentation, many of the miffed attendees walked out. The 'what's-more-important-to-me' decision was commented on immediately in the business press.

Having won the Cup two times in four attempts, a Champagne-splashed Ellison told the press that he had already received a challenge for the next America's Cup. He declined to say who it was from, but the next day's rumors had it coming from Australia.

Ellison acknowledged that one of the biggest challenges of the next America's Cup will be to "get more countries to participate while keeping the event as spectacular as it was this year." At first glance, it would

"If you didn't enjoy today's race [#10], you should probably watch another sport." — Dean Barker

seem that the easiest path to that goal would be to go with one-designs, or at least have most of the more critical and expensive parts be one-design, and eliminate the wings in favor of soft sails. We're not against wings in principle, and the technology is already there. The problem is that they require so many people — 30 to 50 in the case of the 72s — to step and unstep each day. Suddenly, the team payroll becomes astronomical. While MOD70 trimarans — or something similar — might not be quite as fast or quite as thrilling as the AC72s, they can certainly be a lot less expensive to build and maintain.

In the right wind conditions, 10 knots to about 22 knots instead of 5 knots to 33 knots as originally planned, the AC72s proved to be spectacular boats. The fact that they are unsustainably expensive

After rarely opening his mouth for the duration of the Cup, Larry Ellison let loose with a big whoop after winning. He's now 2 for 4.

Ellison has so many mansions, yachts, jets, islands and whatnot, that we've always wondered how much he cared about the America's Cup. Was he involved in it because you gotta do something with the spare tens of billions you have lying around, or was he truly passionate about yacht racing?

That question was answered emphatically by his actions the day before the final race. Slated to give the important 'Cloud Keynote' speech at Oracle Open World, the conference in San Francisco that more than 60,000 people from around the world had paid \$2,500 to \$3,000 to attend, Ellison not only kept the crowd waiting for 45 minutes, he ended up being a no-show. When it was announced that an underling rather



ABNER KINGMAN / ACEA

AMERICA'S CUP

to maintain and difficult to sail means it's unlikely that we're going to see anything quite as spectacular anytime soon — although a source inside the Oracle camp told us they will be shipped, along with five years of spare parts, to Ellison's island of Lanai. What he would do with them there is beyond us. But we are going to miss seeing them streaking across San Francisco Bay.

Ellison's other challenge is with the city of San Francisco. While Mayor Ed Lee has stated he wants the America's Cup to come back, a lot of San Francisco officials and residents have such hatred of the rich that they'd cut their noses off to spite their faces. Like Ellison or not — he said he doesn't take it personally if local sailors supported the Kiwis, as many did — the America's Cup brought a lot of people, good publicity and money to San Francisco. It would be a great thing if the next Cup had 10 syndicates or more. We believe it could do that, plus also attract a lot more people and superyachts — the latter being another attraction that people love or love to hate.

The current status is that Ellison will



FRANCES KUPERSMITH / ACEA

Everybody loves a winner. By the time Oracle crossed the line to win the Cup, tens of thousands had jumped on their bandwagon.

discuss the site of the next America's Cup with senior members of the team, and with local government officials. He says he personally would like to see it stay on the Bay, if possible. He cited the beauty, the great sailing conditions — and the fact that he has a home here. But honestly, having seen these spectacular sailing machines match racing and reaching speeds of up to 47.57

knots (ETNZ) where everyone can see them from shore, we wonder how the America's Cup could be held anywhere else.

But now is not the time to worry about things like that. Let's just savor the incredible sailing spectacle that we were lucky enough to experience — with a giant assist by Stan Honey and his Live-Line team — and the amazing comeback on the part of Oracle Team USA. It truly was one for the ages.

— **latitude 38**/richard

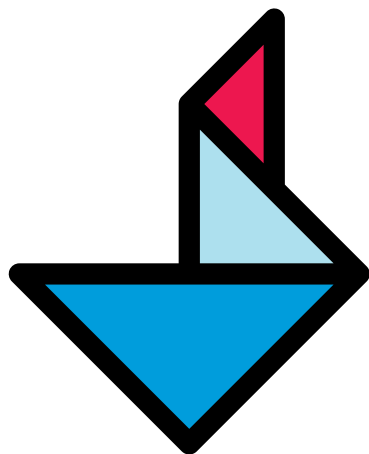

**SAN FRANCISCO
BOATWORKS**

San Francisco's boatyard | www.sfboatworks.com

Marine parts and supplies



Complete haul and repair



Engine repair and service



**Contact us for seasonal
discounts & special offers**

Authorized dealer for:

YANMAR

**marine services
for power & sail**

415.626.3275

info@sfboatworks.com

835 Terry Francois St.

San Francisco, CA 94158

Special for New 28-ft and Under Berthers

Two Weeks Free! Every Month!*

Our docks are ideal for:

Santana 22 • Cal 25 • Pearson 28
 Ranger 23 • Cal 20 • Ericson 25
 Folkboat • Dana 24 • Pearson 26
 Ranger 26 • Catalina 22 • Cal 27
 Catalina 27 • MacGregor 26



PETER LYONS / WWW.PETERLYONSPHOTO.COM

*Turning back the clock
 on rates to 1980!*



Enjoy the convenience of a
 slip at half price for a full year!
 Call for details today.

**Offer expires Oct. 31, 2013.
 New berthers only.*

(510) 522-9080
www.fortman.com

Ballenger Spar Systems, Inc.

**Custom Racing and Cruising Spars
 Expert Design and Consultation**

- Carbon and Aluminum spars
- Rod and wire rigging
- Hi-tech and conventional halyards
- Spar kits, extrusion
- Repair and modification
- Custom fabrication, waterjet and CNC
- Hardware, sheaves, spreaders
- Bay Area pick-up and delivery
- **Discounts** on halyards, standing rigging, deck hardware, furlers, Navtec integral cylinders
- Over 40 years experience!

**Call about Carbon Spars.
 Masts • Booms • Poles**

www.ballengerspars.com

831/763-1196
831/763-1198 (fax)



SCHEDULING YOUR PROJECTS NOW

Huge Rope Inventory
 Call for a quote on your
 running rigging needs!

*Please stop by our showroom to experience the
 difference a knowledgeable rigger can make.*

HANSEN RIGGING

(510) 521-7027
 2307 Blanding Ave., Alameda
 hansenrig@sbcglobal.net

www.hansenrigging.com

EYE ON THE BAY —

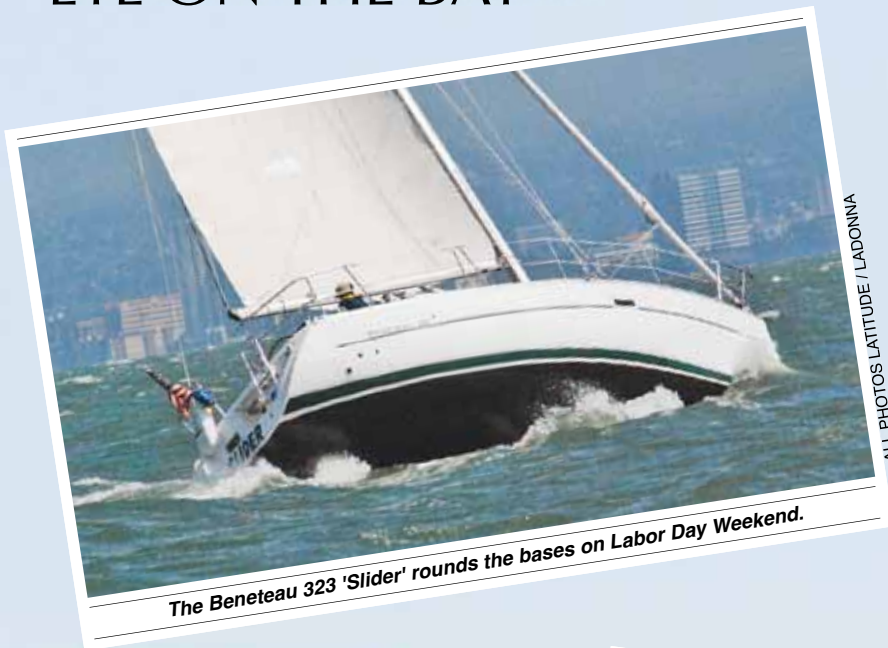

The Beneteau 323 'Slider' rounds the bases on Labor Day Weekend.

ALL PHOTOS LATITUDE / LADONNA

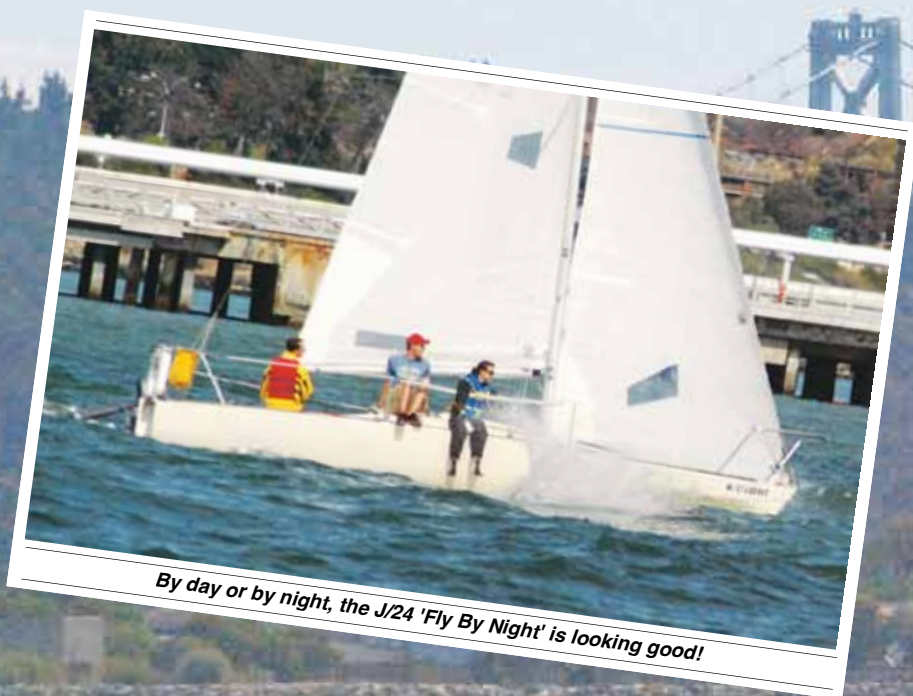

By day or by night, the J/24 'Fly By Night' is looking good!

For many sailors, Labor Day Weekend marks the end of the summer sailing season. Beer can racing starts to wrap up, the crew — aka your kids — go back to school, and the Bay's typically strong summer winds start to mellow. This year, it also marked the start of the Red Bull Youth America's Cup, so it was no surprise to see dozens — maybe even hundreds — more boats than usual out enjoying the beautiful weather that weekend. In fact, small marine businesses around the Bay report they've been busy this summer with sailors pulling their boats out of mothballs to enjoy the America's Cup spectacle.

Hopefully those who got swept up in AC Fever will keep their enthusiasm for the sport fresh by taking their out boats frequently in the coming months. After all, why else do you own it? If you're lacking crewmembers — those darn kids — check out our free online Crew List (www.latitude38.com). There's no shortage of folks looking to go out for daysails or even learn the ropes of racing during some laid-back Midwinters. Whatever you do, just keep feeding the fever. See you out there!

— **latitude/ladonna**

Spread: We doubt the crew of the Beneteau First 35.7 'Painkiller' was feeling anything but pleasure on this beautiful day of sailing.

FEED THE FEVER



'Galatea', an Aphrodite 101, proves her pedigree.



FABULOUS FLEET RACING —

The folks at Red Bull know a winning concept when they see it. Whether it's mountain biking exhibitions, surf contests in exotic locations or Formula 1 World Championships, Red Bull is one of the best in the world at making sponsorship and marketing of extreme sports work. The latest example was the hugely

dominated. In fact, after five races, five different teams had scored bullets. Incredibly, at the beginning of the final day of competition, there was a mathematical possibility that any of nine teams could claim overall victory because the final race was to carry double points.

Ultimately, though, nobody could top the New Zealanders. Young sailors from that tiny island nation not only won the regatta, but took the top two spots in what was an incredible display of young sailing talent. If these kids are the future, then the rest of the world better watch out; New Zealand will be hell-bent on defending the Youth America's Cup (if the event is repeated).

NZL Sailing Team, supported by ETNZ, won the regatta in commanding fashion. With two-time Olympian Peter Burling at the helm and fellow Olympic silver medalist Blair Tuke calling the shots, NZL turned it up a notch on days three and four, and were simply untouchable, winning by an impressive 12 points.

Tied after day two with the San Francisco-based American Youth Sailing Force (who won the first race), Burling and crew took two perfect starts on day three and converted them into two victories, while their nearest rivals, AYSF and New Zealand's Full Metal Jacket Racing, both suffered.

Going into day four, podium positions were far from being assured due to the eighth race's double-points wild card. The outlook for each team differed wildly: For NZL Sailing, the boys merely needed to get the boat around the course cleanly to claim overall victory. Meanwhile, the

AYSF crew were desperately trying to get back in touch with the leaders and preserve their podium position, while their fellow countrymen on USA 45 Racing — who'd been consistently near the back of the pack — just wanted a good result to save face.

At the beginning of day four, Objective Australia was back on pace after boat problems, protests and redress, and the crew hoped to continue their meteoric rise up the leader board. Coming in last twice during the first two days, and scoring of 2-2-3 in races five through seven, Objective Australia desperately needed the valuable double points that race eight could provide, and looked likely to leapfrog to a podium position, or at least into the top five.

In race seven (the first on day four), the Swiss entry Team Tilt shot out to an early lead after a perfect start and held on for a wire-to-wire win, while Portuguese Olympian Bernardo Freitas steered ROFF/ Cascais to a hard-fought second, allowing his team to move into a podium position for the regatta.

Burling and crew sailed smartly and conservatively to finish fourth, while the AYSF got buried early. Rounding the first mark in last place, AYSF could only manage an eighth-place finish, which knocked them off the podium.

The breeze built before Race 8 began, necessitating a wind hold. After a half-hour postponement, the race committee made the call; There would be no Race 8. With winds exceeding the imposed 18-knot limit by a mere half-knot, but building, the final double-points race was cancelled. It was a crushing blow to several teams who'd hoped to mount an 11th-hour comeback. Many fans



In the final race, youth athletes from tiny landlocked Switzerland showed what lake sailors can do — with a wire-to-wire victory.

successful Red Bull Youth America's Cup (September 1-4), which produced some of the most exciting racing staged on San Francisco Bay in recent memory.

Ten youth teams (aged 19-24) from eight nations competed in a four-day, eight-race series aboard wing-sailed AC 45 catamarans to determine a champion.

One thing that made the event especially thrilling was that no team

In contrast to the AC72s used in the America's Cup, these AC45s are virtually identical other than their colorful graphics.



RED BULL YOUTH AMERICA'S CUP



ACEA / GILLES MARTIN-RAGET

in the grandstands felt equally dejected.

The Local Impact

As hoped and anticipated, the local sailors of the American Youth Sailing Force — aka The Force — have done the Bay Area and the United States proud. The boys came charging out of the gate to claim a shocking and resounding victory in race one. Looking to have the tides, boat and race course dialed early, they got buried in race two, finishing seventh. The 1-7 scorecard on day one was par for the course, as they were tied with FMJ and just four points behind NZL Sailing. After day two's consistent 3-5 scorecard and NZL's comparative 7-3, the San Francisco team was tied for the lead.

A collective sense of local and American pride energized the local sailing contingent, sending fans in droves to the Marina Green to witness the young American squad duke it out with the Kiwis. Red, white and blue face paint and bikini-clad young women draped in American flags created a raucous, nationalistic setting, more akin to a World Cup soccer match than a sailing race. A difficult third day still saw the AYSF tied with the Kiwi FMJ team for second place.

But the final day wasn't kind to the home team. With the aforementioned eighth in race seven, AYSF was one of several teams that was potentially ham-

It's hard for a typical non-sailing sports fan to wrap his head around match racing. But in fleet races it's always obvious who's winning.

pered by the cancellation of the double-points race eight. Losing valuable points in the seventh race, AYSF brought home a solid fifth-place finish for the regatta, just two points off the podium and three points behind second. Had the boys finished fifth or higher in the last race, they would have wound up second in the regatta. That's how close the competition was in the Red Bull Youth America's

Cup.

If there's one aspect of this America's Cup that clearly "works" with the public and created very viewable content with mass-market appeal, it was the film and television package, which included young sailing filmmaker Sam Greenfield. His series of videos documents the daily life, trials and tribulations and human aspect of the Force. The result is highly

Portuguese hotshots chase their Kiwi rivals around the course. The action was always fast-paced and thrilling to watch.



FABULOUS FLEET RACING —



RED BULL / BALAZS GARDI

ALL PHOTOS ACEA / GILLES MARTIN-RAGET EXCEPT AS NOTED

entertaining, educational and inspiring, with several Force members becoming near household names — at least among local sailing fans — by the end of the regatta.

As for the other American team, USA 45 Racing, the Red Bull Youth America's Cup gave them a thorough drubbing and left them beaten down and dejected. Thoroughly off the pace from day one, the team just could not hang with the others and recorded a top finish of 7th, among a card full of 9s and

10s. As predicted, a roster full of sailors whose experience was limited to college dinghies didn't help much when pitted against world-class talent in ultra-fast apparent-wind sailing catamarans.

Back to the Future?

It's been said a million times before, but AC45s are a solid, reliable and exciting platform that has now proven itself through several evolutions of close one-design racing. Combine the sensibility of the AC45 with some of the best young

sailing talent on the planet and you have a winner. Throw in the considerable technical expertise of America's Cup Event Authority (ACEA), America's Cup race management (ACRM), AC TV's LiveLine graphics and independent filmmakers, and you have the highly successful Red Bull Youth America's Cup.

The product delivered to spectators was top-notch and as is often the case, a TV monitor was the best way to view it. The only problem was that you had to watch it online and had to really know

RED BULL YOUTH AMERICA'S CUP



Clockwise from upper left: Portuguese in a squeeze; the AC45 ab workout; Aussies show their guns; winners NZL Sailing celebrates with a bit of bubbly; the AYSF bikini team; no one sits idle on ROFF/Cascais; Kiwis and Yanks in close quarters; The Force off the wind; Kiwis trim for speed.

how to watch the event. Considering the substantial resources that were invested in this inaugural event, it was a shame to see almost no mention on Red Bull's corporate website and no real TV feed. In the realm of professional sailing sponsorship and the all-valuable return on investment, the race may have been a flop. But to the sailors and fans that did manage to follow the races, it was a

regatta to remember.

Cooper Dressler, an AYSF standout, said of the regatta, "Everyone is really happy with how the event went. The AC 45s and the racing were great! I think the formula created a great product and hopefully this thing (RBYAC) can continue. We sailed hard and had the time of our lives!"

Let's hope Cooper is right and that

the Red Bull Youth America's Cup does indeed live on. With modest operating costs and the promise of reliably competitive racing, this would seem to be a sustainable event that just might connect with non-sailing sports fans in addition to hardcore sailors. Let's hope Red Bull continues to "give you wings."

— **ronnie simpson**

For a look at the wildly mixed results see: www.americascup.com/en/results-standings.

LYNN RINGSEIS

DELTA DOO DAH DIY

The concept behind creating the Delta Doo Dah wasn't complicated: Hold an event that will get folks to sail their boats to the Delta. At the height of the recession, far too many boats were growing to the bottom, and Delta marine businesses were hit especially hard by the economy. Since the Delta is a mere daysail away, we hoped the event would kill two birds with one stone.

As readers know by now, the response to our laid-back little rally was overwhelming. For four fabulous years, we led dozens of boats upriver to escape the

Bay's frigid summer winds and bask in the warmth of the Delta.

But this year was different. With America's Cup mania building, not to mention filling most of the summer's sailing calendar, choosing dates for this year's Doo Dah proved impossible. Besides, if we didn't want to miss any of the on-the-

water action, how could we expect Doo Dah'ers to miss out?

So we followed in the wake of our sister event, the Pacific Puddle Jump, and set dates for the 'event' that would allow folks to head upriver whenever



The kids from 'Tonic' seem to prefer freshwater.

SIMON ADAMS



DAN BAKER

ALEX PEARCE

Do it yourself — (top row, l to r) Danielle and Nicole take a flying leap off 'Fuzzy Logic'; Sweeet; The Richmond YC 4th of July dinghy raft-up at Potato Slough; Walking on air; (middle) The 'Tazman' crew spent the whole summer in the Delta; A sip of 'Sweet Tea'; Rocking out on 'LaDonna Jean'; (bottom) There's more than one way to sail in the Delta; A stunning sunset at Mildred Island as seen from 'Flibbertigibbet'; 'Prime Time' and 'I'm a PC' visit Bethel Island's Sugar Barge; You never know what you'll wake up to on 'Guenevere'.



DAVID SAWYER



DOODETTE LADONNA



JIM ADAMS

2013 Delta Doo Dah DIY Participants

03
After Fifty
Alias
Andiamo
Andiamo
Antares
Aquarius
Aquavit
Ardea
Balaton
Because...
Beso del Mar
Bloom County
Bravo Zulu
Brillin Leannen
Bumpy
Caesura
Calm
Cherish Again
Chester P
Chimera
Clarsa
Destiny
E.C. Rider
Evenstar
Exit Strategy
Firebolt
Flibbertigibbet
Free Spirit

Willard 30 SRB
Hunter 340
Hylas 47 cutter
Islander 32
Islander 36
Catalina 27
Atlantic 44
Swan 36
Tartan 37
Nauticat 42
Jeanneau 45DS
Hunter 46
Islander Bahama 30
Downeaster 33
Ericson 29
C&C 40
Ericson 35
Cirrus 22
Island Packet 440
Aries 32
Little Harbor 47
Newport Venture 23
Catalina 30
Catalina 25
Ranger 23
Amel Maramu 46
Laser 28
O'Day 34
Islander Bahama 30

David Hardy
Mark & Sherrill Zeserson
John & LaShandra Fluno
Paula & Russell Sunn
Eli Myrick & Akio Omori
Peter Froehlich & Ediee Van Leuvan
David Feldman
Bruce & Gail Sinclair
Jim & Georgianne Boissier
Louis Burgyan & JoAnn Arreola
Tim & Ian Shea
Steve & Elizabeth Weiss
Jess & Denise Stephens
Conrad & Majel Arnold
Robert Lensch
Rich & Shawn Wideman
Quinn McKenna & Mary Eaves
Clemens & Angelle Heldmaier
Erik Johnson & Jennifer Miller
Chuck Bullett & Lisa Chapin
C. Grant & Barbara Miller
Bill & Kathy Crowley
Justin McCarter
Matthew Loeffler & Brigitte Bowers
Gregory Towers & Jillian Cripps
Dave Benjamin & Jean Harrison
Mike & Jennifer Holden
Jim & Betty Adams
Stuart & Bonnie Lochner

Flying Baby
Fuzzy Logic
Galen
Gazelle
Georgia
Guenevere
Hotel California
I Am a PreCursor
'Imi Loa
Island Bird
Itzayana
Jane'O
Jenna Renee
Knot Studying
Knotty Gale
Kollisza
Kranich
Kyra's Joy
La Buena Vida
La Vida
LaDonna Jean
Levon
Little Lara
Lucy!
Mai Pen Rai
Margaux
Marjul
Marrakesh
Mary Emma

32-ft J/100
Hunter 35
Beneteau 42 cc
Wauquiez 47
VanDeStadt 41
Nor'Sea 27
Catalina 375
MacGregor 25
Ericson Indepen. 31
Cavalier 39
Beneteau Oceanis 331
Privilege 39 cat
Beneteau 373
Hunter 33
Coronado 27
Catalina 22
Ericson 38-200
Catalina 36
O'Day 222
Catalina 320
Cascade 36
Cape Dory 28
Dana 24
Beneteau 343
Islander 36
Morgan 38
Grand Banks 32
Express 34
Catalina 380

Michael & Everett Rosauer
Dan & Kathy Baker
Erik Engstrom
Rob Tryon & LaDonna Bubak
Ben & Lucie Mewes
Greg & Jill Delezynski
Michael & Linda Stafford
Bryan & Cindy Blagg
Rowan Maddox & Devon Quinn
Edmundo & Mary Larenas
Liam Wald & Jane Wong
Scott & Christine Emmons
Nick Harden
Mike Dvorak & Lindsey Gooshert
Tim Caruso & Gayle Deluca
Pete & JoD'Ann Smalley
Peter Buettner & Elke Specht
Peter & Georgianne Pillsbury
David & Karen Lessard
Michael & Joan Mellon
Alex & Tara Pearce
Lewis Keizer & Marie Lumazar
Jay & Peggy Bowden
Roy & Barbara Johnston
Noble & Barbara Brown
Patrick & Sharon Hind-Smith
Wayne Dutton & Stella Rebolgar
Craig & Ann Perez
Ken & Sandy Fouts



KATHLEEN DOLAN



ALEX PEARCE



ALEX PEARCE



ALEX PEARCE



BRYAN BLAGG



JILL DELEZYNSKI

Mermaid Hunter
Mi Amor
Migration
Miss Conduct
Neener3
Nomad
Now and Zen
Nutmeg
Odyssey
Odyssey
Over Forty
Pacific Dragon II
Pebbles N BamBam
Peggy-O
Pippi Longstocking
Popeye
Prime Time
Pronto
Pura Vida
Pyewacket
Red Sky
Resolute
Rol Tack
Sea Bird
Sea Star
Seaya
Shamwari
Sizzle
Smooth Jazz

Hunter Cutter 37
 Islander 36
 Catalina 36
 Columbia 36 cutter
 Catalina 42
 Rival 36
 Newport 30-II
 Catalina 38
 Bristol Channel Cutter
 Jeanneau 37
 River Queen 40
 Gemini 105mc cat
 MacGregor 26
 Catalina 34
 Columbia 28
 Nordic Tug 34
 MacGregor 26
 Catalina 34
 Hylas 47
 Catalina 34
 Beneteau First 36.7
 Hunter 33
 North Star 29
 F-27 trimaran
 Cal 39
 Catalina 380
 Tayana 37 cutter
 Spirit 28
 Catalina 320

David & Susan Wilson
 Arnie & Louise Gallegos
 Chuck & Mary Ann Herman
 Dan Zempel & Michelle Petroelje
 Jan Grygier & Patricia Boucher
 Robert Cohn & Margo Louwerse
 Tony Bourque & Patch Garcia
 Fred Meis
 Wayne & Karen Edney
 Doug Vaughan & Karis Forster
 Bill & Cindy Copp
 David Hurdle
 Russell Schulz & Solange Sallabery
 Sam Turner
 Amanda Burton
 Jim & Mimi Cornelius
 Ed Dietz
 Robert & Mary Pankonin
 Greg & Melissa Davids
 Ralph & Penelope Hyde
 Adam Thier
 Jason & Eric Kopps
 Timo Schurg & Najlae Nejar
 Rich & Mary Holden
 Bob Walden & Lori Tewksbury
 Mark Thompson
 Charles & Cecilia Lane
 Erik & Brian Jones
 Peter & Iris Acutt

Solitude
Spirit
Starkite
Stink Eye
Sweet Tea
Tasman
Thetis
Three Sigma
Tonic
Toucan
Touché
Trillian
Two-Can
Twilight
Two Truths
Vaga Rio
Valkyrie
WindChaser
WindDancer
Windmill
WindSong
Zeehond

Islander 36
 Catalina 309
 Catalina 30
 Laser 28
 Moore 24
 Ericson 32
 Ericson 32
 Corsair F-27 tri
 Roberts 58 PH
 Tanton 43 cat ketch
 Jeanneau 42DS
 Sabre 32
 Islander 36
 Catalina 30
 Dana 24 cutter
 Catalina 22
 Ericson 30 cutter
 Cal 2-29
 Beneteau 323
 Catalina 30
 Catalina 42
 Newport 30 MkII

Jay Lund
 George Reed & Sara Ann
 George & Cyndi Durden
 Jonathan Gutoff & Christine Weaver
 Robbie Ann & Ruben Gabriel
 David & Ruth Sawyer
 Steve Andersen
 Christopher & Patricia Harvey
 Simon Adams & Brandy
 Kevin Belcastro & Susan Liebert
 Phillip & Jill Ziman
 Scott Gray & David Wyskiel
 Craig & Tammy Vitt
 Neil & Judy Larson
 Bob & Betsy Sharf
 Tom Shuster
 Gabriel Black & Kara Kambietz
 Mark Dallow & Lauren Knobel
 Joe Bunker & Julia Rigler
 Jennifer Mengel & Doug Jarmer
 Al & JoAnn Wallash
 Donn Guay & Diane Memory

DIY Sponsors

Berkeley YC berkeleyyc.org • Cal Boating dbw.ca.gov • California Delta Chamber of Commerce californiadelta.org • Martinez Marina martinez-marina.com • Owl Harbor owlharbor.com • Pirate's Lair pirateslair.com • Richmond YC richmondyc.org • Sacramento Delta Bay Marina sacdeltabaymarina.com • Sacramento River Boating Guide sacboating.com • Southbound Solar southboundssolar.com • Stockton SC stocktonsc.org • Survival Straps survivalstraps.com • Tiki Lagun Resort & Marina tikimarina.com • Water-Jel Unburn Sunburn Relief waterjel.com

DELTA DOO DAH DIY

their schedules would allow, rather than organize a guided rally as we'd done previously. This meant that we no longer had to limit the number of entries — anyone could go at any time!

More than 100 boats signed up for Delta Doo Dah DIY, and we know of many more boats that went to the Delta this summer but didn't register. What did they miss by not registering? Oh, only discounted moorage at Martinez Marina, Owl Harbor, Sacramento Delta Bay Marina, Stockton Sailing Club and Tiki Lagun Resort & Marina; great prizes from *Latitude 38*, Southbound Solar, Survival Straps, and Water-Jel, not to mention the chance to win the new Delta cruising guide *Sacramento River Boating Guide* by Bill Corp; and don't forget a couple of really fun parties!

The Kick-Off Party was held on May 10 at Berkeley YC, where tons of prizes were handed out and Delta boating experts answered questions for newbies. It



Little Venice Island offered up some idyllic scenery for relaxing into a good book.

also offered Doo Dah'ers the chance to meet others who might be heading their direction at the same time. Even so, it was hard not to bump into other Doo Dah'ers along the way. "I met a couple of other Doo Dah boats by chance at Herman & Helen's, near Stockton," says Steven Andersen of the San Rafael-based

Ericson 32 *Thetis*.

Several Doo Dah'ers report spending the entire summer in the Delta, and to them we say, 'Well done!' David Sawyer of the Ericson 32 *Tazman* says his family took five multi-day mini-vacations in the Delta while their boat was at Owl Harbor. "The weather was always perfect!"

Others sailed upriver more than once. "We headed up in July and will be going back up again in October," report Rich and Shawn Wideman of the C&C 40 *Bumpy*.

Even Doodette Christine made the trip twice. "Well, the first one was in the Delta Ditch Run," she notes. "Does that count?" We think so!

So if you sailed to the Delta this summer — as part of the Doo Dah or a club cruise — be sure to drop by Richmond YC on October 10 (6-9 p.m.) for our Reunion Potluck Dinner. Bring your favorite dish, some cash for the bar and your tallest tales of a summer well-sailed.

— **latitude** /doodette/ ladonna



OWL HARBOR MARINA — LIKE NO OTHER.

ISLETON, CALIFORNIA
OFF THE SAN JOAQUIN — CHANNEL MARKER 41

WE LOOK FORWARD TO SHOWING YOU A NEW WAY OF BOATING.

916-777-6055

WWW.OWLHARBOR.COM

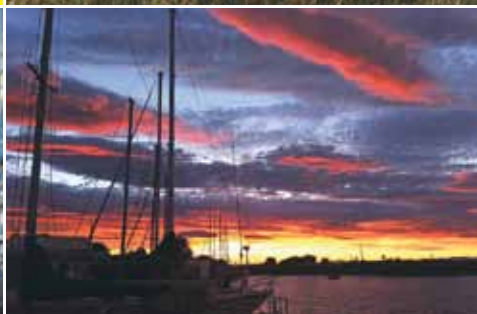

'Electronic Latitude

has lots
of
**'Unique
Visitors'!**

**A damn
fine read!**

- 'Electronic Latitude can be found at www.latitude38.com
- Four or five great stories and photos every Monday, Wednesday & Friday
- Debuted in April, 2000

Subscribe today for FREE at: www.latitude38.com

COVER CRAFT

Exquisitely Crafted custom canvas

"I have been meaning to write you guys and tell you what a great experience we had having you work on our boat. You did such an amazing job, and we continue to get compliments!" – V.K.



All sewing in Tenara thread.

- Classic dodgers and biminis
- Drop-top folding dodgers
- Custom canvas for sailboats

560 W. Cutting Blvd., #2
Richmond, CA 94804
Inside the KKMI boatyard

(510) 234-4400

Quality
Yacht
Canvas

McDERMOTT COSTA

insurance brokers - est. 1938

Commercial Operations

- COMMERCIAL POLICIES
Marinas, Yards,
Yacht Clubs,
Brokers,
Shipwrights

Recreational Inshore/Offshore

- YACHT & BOAT POLICIES
Offshore, Coastal,
Inland and
Liveaboards

**CALL FOR
2013
QUOTES**



Lic. #OB21939

BILL FOWLER – Marine Specialist
McDERMOTT COSTA INSURANCE
(510) 957-2012 Fax (510) 357-3230
bfowler@mcdermottcosta.com



FOOD FOR THOUGHT —

After a decade of doublehanded cruising around the world aboard their Deerfoot 74 Interlude, Alameda-based sailors Kurt and Katie Braun have plenty of time-proven advice to share. And while we're not completely sold on all of the opinions stated here, their ideas certainly offer worthwhile food for thought. (Look for a second installment of this series next month.)

Helpful Concepts

Conventional Travel vs. Cruising: We suggest taking a hard look at your goals in life and the best ways to achieve them. Fun, adventure, camaraderie, experiencing new places and cultures, helping people, personal growth, etc. are all cited

Chartering vs. Owning: Boats are like spouses; they like time, attention and money. If you want the cruising lifestyle, but not the time spent crossing oceans or performing maintenance, consider chartering. We have found that maintaining the value of a boat requires spending roughly ten percent of the purchase price annually. Some items will be amortized over ten or more years (sails, rigging, engines, paint, etc.). But it all averages out to about five to fifteen percent depending on how handy you are. Factoring in the cost of capital, insurance and marina fees, pretty soon even a \$10,000-a-week charter is more cost effective, enjoyable and less trying on your marriage than owning your own yacht.

Power Requirements: Too often we see 'green' boats with solar panels and/or wind generators running engines for hours at anchor to keep up with power usage while clogging their exhaust systems with incomplete combustion, or polluting the anchorage with a noisy portable generator.

Although boats can be run solely on alternative energy sources, power consumption must be balanced accordingly. This is best worked out with real-world tests in a location with resources (i.e. before you are halfway to the Marquesas). While *Interlude* is considered by some to be a 'power-hungry boat' with her 70-gallon-per-hour watermaker, household-sized washer and separate dryer, 110-volt audio/video surround-sound system, dive compressor, A/C and heaters, three refrigerator/freezers, autopilot, radar, chartplotter, etc., she was built with a 12kW generator and battery bank designed to keep up with her needs by running efficiently two hours a day.

If your boat is not big enough to have a dedicated generator or you don't have the real estate to safely accommodate enough solar/wind/tow power, you will have to cut back on usage. The Pardeys and many other cruisers including Kurt (during previous voyages) have sailed the world in modern times without electronics (use sextant & leadline), a water-

maker (use a raincatcher), refrigeration (use fresh, pickled, tinned and dried food), autopilot (use a wind vane), or an electric windlass (use a hand crank). Boats of all levels of complexity arrive at the same anchorages and if you can avoid being a slave to your systems you may find yourself having more fun.

Motoring vs. Sailing: While we prefer to sail rather than motor, a greater priority is extending our cruising budget. Know the math on sailing vs. motoring and understand the speed and conditions at which the cost of UV damage and wear and tear on your sails and running rigging is greater than that of using the engine. When we decided we wanted to see this summer's America's Cup in San Francisco Bay, we calculated it was cheaper to motor 3,000 miles from Panama than sail the 6,000 miles via Hawaii. Motoring can also be a safer option limiting your time on the open ocean or allowing you to make landfall during daylight hours. Just as most musicians have day jobs, most sailors will find a use for motoring.

Realistic Provisioning: In almost every nook of the world, beer, flour, rice, sugar, cooking oil, some fresh veggies and eggs can be found. Carry only one month's supply of these items and use the rest of your storage space for spare parts and fancy treats like fine chocolate, dill pickles and gourmet olives.

If you see something that you may want, buy it then and there; otherwise it will most likely be gone if you come back later. Cash is king. The availability of ATMs as a reliable means of obtaining spending money while cruising is spotty. In Vanuatu, we loaned \$300 to a crew of young cruisers who were going to miss out on an experience of a lifetime — viewing

ALL PHOTOS COURTESY INTERLUDE



Not every cruiser has a boat as large and luxurious as the Brauns' Deerfoot, but their advice is applicable to boats and budgets of any size.

as reasons for going cruising. But life is short and maintaining a yacht and floating from place to place may not be the most effective use of your time.

If your idea of cruising is not sitting in a marina and you want to experience remote and exotic places, use your boat to do it while you can. 'Time and tide wait for no man' so when physical challenges begin to mount, we suggest using airplanes and hotels. Use your boat primarily to get to places not easily visited by conventional means, and do so while you are healthy. For example, don't sail to Thailand just to lay your boat up for a season while visiting Vietnam, Cambodia and China, or spend time on mainland Italy, France and Spain while sailing the Med (less expensive and easier seen by land).

But if you enjoy diving atoll passes in the Tuamotus, exploring coves and remote ruins on the Turquoise Coast of Turkey, or spending a couple of months helping kids learn English in a Kiribati village, you can only have those experiences by sailing your own boat there while you are healthy.



FOR SENSIBLE CRUISING

the active volcano on Tanna — because they had no cash on hand to pay a guide. In Saumlaki, Indonesia, we loaned the three other cruising boats on our rally money to buy fresh provisions, as the only ATM in a city of 100,000 people was broken. In Uligan, a convenient Maldivian stop while crossing the Indian Ocean, U.S. dollars were the only way to purchase diesel.

Characteristics of a Bluewater Cruising Yacht

Strength: Regardless of the best weather planning, at some point you will encounter rough conditions. Knowing your boat is tough enough to take a pounding will give you confidence and prevent the embarrassing urge to run around yelling, "Oh shit, we're all going to die!" All hull materials have pros and cons, but our preference is either marine-grade aluminum or thick fiberglass with no core.

Hard Dodger/Pilothouse: Sailing is okay as a contact sport for a few hours, but for crossing oceans a well-sheltered place to stand watch is not only more

'Interlude' is both a performance sailing machine and a well equipped home on the water. And she's relatively easy to doublehand.

comfortable, but safer. With three hours on, three hours off, 24/7 watch-keeping, having a secure place, out of the elements, to monitor conditions will help the crew stay more alert, and preserve any electronics mounted there. Our Deerfoot 74 was designed with a pilothouse, but we know many cruisers that have replaced their canvas dodgers with more substantial fiberglass ones.

Ability to Sail Upwind: Often we hear owners brag about how well their boat sails on a broad reach, and in the same breath admit that it does not sail well upwind. Sailing upwind is, however, sometimes the only option. We have had some of our best passages using a code zero (180% genoa) sailing upwind in light conditions. Going up the Red Sea we took advantage of wind aft of the beam for 800 miles, knowing we could beat into 30 knots for the final 300 miles to Egypt to conclude our 17-day passage. Fellow cruisers who did not take advantage of



When your destination lies upwind, it's nice to have a boat that can get you there under sail rather than by day after day of motoring.

the weather window and couldn't sail well upwind took weeks longer, covering the 1,100 mile distance in short hops under power.

Waterline Length: Unless you plan on spending a lot of time in marinas your money is best spent on waterline. A larger boat is likely faster, more comfortable and roomier for storing all those spare parts and toys. We know plenty of folks who have more money invested in a tricked-out 46-footer than they would have spent on a 60-footer with basic gear for shorthanded sailing.

However, if you are on a budget we recommend something like a Peterson 44 with a hard dodger, as it meets our requirement of a boat that can sail 150-200 miles a day in decent wind and is still strong enough to push on in rough weather.

Good Engine: Sized for wind (not water) resistance (40 knots), easy to maintain and lacking in computer chips (now illegal in the USA) are important cruising boat engine characteristics. Knowing of numerous boats that have lost systems to lightning strikes or power surges, we opted not to repower, but found a new factory long block for our old Isuzu marinized diesel truck engine. Though we have to put up with less fuel efficiency and more weight, we know this engine will be reliable and will not require a computer technician and spare electronics to keep running. And it can be repaired anywhere in the world.

Essential Equipment

Communications Without Wi-Fi or Cellular: To cross oceans, an HF radio (SSB/Ham or at least SW) for weather forecasting and cruiser nets and/or an Iridium satellite phone for weather, email



FOOD FOR THOUGHT

and calling home are a must. Although we both have our amateur radio licenses and find the cruiser radio nets useful, an Iridium satellite phone is more reliable and versatile for downloading GRIB files and direct calling. For little more money than a Facter modem plus SailMail service, onboard email through a satellite phone is much easier (use an email consolidator like www.uuplus.com). We've had friends who went all the way across the Indian Ocean with no weather data because the SailMail and Winlink servers could not be reached.

Serious Groundtackle: 300 feet of chain, an oversized anchor and a powerful windlass will keep the captain and crew sleeping well at night, and unafraid to leave the boat all day for shore excursions.



Don't skimp on anchoring gear. Your life — and the safety of your boat — will almost certainly depend on it, wherever you cruise.

sions. Take the suggested anchor weight, double it, and size your windlass so that you can bring it and all your hanging chain up without overheating. We have arrived at an anchorage to find the only practical place to drop the hook is in 80-100 feet of water. A heavier anchor will allow you to be secure with only 3-to-1 scope if necessary. In anchoring over 1,000 times with our 80-kilogram Bruce, we have never dragged — even in 50-knot winds.

Spare Parts for Critical Gear: If you can't live without a piece of gear then you need to have the parts and knowledge to fix it yourself. We carry more spare parts than food because people need to eat everywhere, but many places do not have the availability, or adequate transportation, to replace a critical part. A big mistake is assuming that because your boat is new you do not need to worry. Systems yet to be tested under fully stressed conditions can easily fail as well.

Rain Catcher or Watermaker: Carrying enough fresh water to keep the cabin, crew and critical gear salt free will help you maintain your vessel and keep nasty skin rashes at bay. In the tropics, a good rain-catching awning that will stand up to a squall while at anchor will keep your tanks topped off for the season. We have had visiting cruisers cut their sundowners short, eager to wash their boat and/or bathe during a downpour. Alternatively, have an easy-to-maintain watermaker sized to handle your needs. (Ours makes 70 gal/hour.)



Having an easy-to-maintain, large-quantity watermaker is a wonderful addition to a cruiser's equipment. But it's not essential.

the bow if the situation is really tight.

Watch Commander: Forget egg timers and electric watches. Instead visit www.sailsafely.com to order a timer that may save your boat or even your life. With a dial that allows you to choose from 3 to 27 minutes, and numerous intervals in between, this alarm will remind the on-watch crew it's time to check conditions and course. If the crew doesn't hit the reset button during the one minute of soft alarm, a loud alarm will go off, not only getting the attention of the snoozing crew who's on watch, but also waking up the entire ship. For double-handed cruisers, this device also serves as a MOB alarm, albeit somewhat delayed.

(Anytime we're sailing far enough offshore that we can't swim to safety, we use harnesses and jacklines).

Overrated Equipment

Bow Thrusters: Day sailors might find a bow thruster useful for frequent docking, but offshore cruisers are typically either at anchor or are in marinas for extended periods, leaving this device to grow barnacles and become just something else to maintain. Without a bow thruster on our 74-foot yacht, we always reconnoiter a new slip by dinghy or at least download a Google Earth image or marina diagram ahead of time. We advance-plan all maneuvers, enter at the calmest time with the least current if possible, usually back in to tight places, use prop walk to turn, and a breast line amidships to stop the boat and pull us into the dock. If a marina tender is available we ask that they stand by to push

Sea Anchors: We have spoken with numerous Kiwi cruisers who used their New Zealand Category One-required parachute anchor only to find themselves trapped in a fierce storm for days. When conditions abated and sailing could normally be resumed, they had problems retrieving it, wrapping the thing around various appendages and injuring themselves in the process. On the 2005 ICA rally to Fiji, several boats deployed sea anchors or stopped at Minerva Reef, causing much grief and damage, while *Interlude* and other boats pressed on, avoiding the worst of the storm, and arrived many days sooner.

Extra Crew: We shared the Baja Ha-Ha experience with friends aboard, but for passage-making we prefer a boat equipped so that you can move it without extra crew. We joke that crew is a four-letter word, and we know many 'bad crew' stories involving folks that are no longer talking to their former BFFs. Too often, we hear of cruisers missing a great anchoring spot or pushing on in the face of bad weather because they had crew or visitors to meet. We welcome guests, but our motto is if someone wants to visit us they can pick either the time or the place, but not both. This ensures we will not put ourselves at risk trying to



This simple yet effective device was invented by a circumnavigator.

meet a timetable.

— kurt & katie braun

Ed. note — We'll pick up here next month with a second installment of tips and recommendations. In the meantime, you can visit www.sailinginterlude.com for further insights.

BAJA HA-HA XX

BROUGHT TO YOU
BY THESE
OFFICIAL SPONSORS



WWW.BAJA-HAHA.COM

The Rally Committee encourages you to patronize the advertisers who make this event possible – and take advantage of their Baja Ha-Ha Specials! (Turn the page for more.)

Your
Yacht Club
South of the
Border



Home
of the
Banderas Bay
Regatta

Vallarta Yacht Club

<http://vallartayachtclub.org>
<http://banderasbayregatta.com>

Everything you need from a full service yacht club.

**Nautical Books, Software, Charts
and more!**



WAYPOINT

621 - 4th St., Oakland, CA

www.waypoints.com • (510) 769-1547

RIGGING ONLY

Standing and running rigging, lifelines, furlers, winches,
headsail poles, main slider systems, windlasses,
travelers, wire terminals, blocks and more...
Since 1984 Expert advice for selection and installation.

www.riggingandhardware.com
(508) 992-0434 • sail@riggingonly.com

ICOM®

Award-winning Marine Communications Equipment

Handhelds • Mounted VHF • SSB • AIS

Visit one of our many West Coast dealers

www.icomamerica.com/marine

BAJA HA-HA MELTING POT

One look at the Ha-Ha XX entry roster at www.baja-haha.com shows you that boat types in this year's fleet were as varied as ever, and you can bet that the crews who sail them are as colorful as in years past.

In addition to many first-timers, there were plenty of 'repeat offenders' who want to replay some of the fun and great sailing that they'd experienced the last time around. Some full-time Mexico cruisers even sail all the way back to San Diego each fall just to re-do the rally.

If you're new to the event, let us explain that the Ha-Ha is a 750-mile cruisers' rally from San Diego to Cabo San Lucas, with stops along the way at Turtle Bay and Bahia Santa Maria.

You'll find occasional updates about this year's event on 'Lectronic Latitude'. Check it out at: www.latitude38.com.

Summer
is safe at
Paradise



Enjoy
your stay
with us!

011-52-322-226-6728 • www.paradisevillage.com
marina@paradisevillagegroup.com

SELF-STEERING AND EMERGENCY RUDDERS



SCANMAR

Factory
Direct

432 South 1st Street • Pt. Richmond, CA 94804
Toll Free: (888) 946-3826 • Tel: (510) 215-2010
email: scanmar@selfsteer.com • www.selfsteer.com

West Marine®

For your life on the water™

Prepare for the 20th Annual Baja Ha-Ha
at a West Marine store near you!

For more locations near you
or to shop online 24/7 visit www.westmarine.com



Est. 1973

Almar Marinas

Everywhere you'd like to be

www.almar.com

BAJA HA-HA XX



THE CRUISER'S CHANDLERY

2804 CAÑON STREET • SAN DIEGO
(619) 224-2733 / (800) 532-3831
FAX (619) 225-9414

www.downwindmarine.com



Let Marina El Cid Welcome You to Mexico

A Cruiser's Paradise!

www.elcid.com

marinaelcidmazatlan@elcid.com.mx
011-52 (669) 916-3468



New Mexican Liability Program

*Lower Rates * Tender Included*
Short Term Policies Available

(800) 992-4443

www.marinersins.com

See Our Half-Page Ad In This Issue

Newport Beach, CA - San Diego, CA
Burlingame, CA - Seattle, WA
Sarasota, FL - *Puerto Vallarta, MX
*Affiliate company dba: Mariners Insurance Mexico

Best Marina in Banderas Bay



MARINA RIVIERA NAYARIT

www.marinarivieranayarit.com

011-52-329-295-5526

BLUE LATITUDE PRESS

The best cruising information for the Sea of Cortez and Pacific Mainland Mexico

WWW.BLUELATITUDEPRESS.COM

SAN DIEGO BAY'S



HARBOR ISLAND WEST MARINA

Serving Southbound Cruisers in San Diego Bay for over 40 years

www.harborislandwestmarina.com

619.291.6440

CALL ABOUT OUR BAJA HA-HA CRUISER SPECIAL!

MEET THE FLEET

Ever since the first Baja Ha-Ha in 1994, these rallies have drawn a diverse mix of sailors, whose professions and backgrounds are as varied as the boats they sail on.

You can get to know the basics about them via our three installments of Baja Ha-Ha mini-profiles (page 108 this month; download last month's edition free from www.latitude38.com). Installment three will appear in November, and you can read a complete BHH recap in the December edition.

IS THE PACIFIC PUDDLE JUMP FOR YOU?

For many cruisers, the next logical step after cruising Mexican waters for a season or more is to hang a right and head west into the Pacific.

We call that annual springtime migration the **Pacific Puddle Jump**, and report on it heavily in the pages of *Latitude 38*. Making that 3,000-mile passage is one of the most thrilling accomplishments in the realm of sailing. Learn more about it at www.pacificpuddlejumps.com.



Sign up here.

Get QR Reader
FREE at your
App Store.

- Ultra Anchors • Ultra Swivels
- Quickline Flat Rope & Reel • Ultra Trip Hooks
- Ultra Chain Grabs, Ultra Snubbers & Ultra Bridles



www.Quickline.us
www.UltraAnchors.us
sales@Quickline.us
714-843-6964

The World's Highest Quality Marine Products



Not just a marina - a cruiser's community
Your best destination across the Sea...

www.marina-mazatlan.com

011-52 (669) 669-2936 & 2937

jaimeruiz@marinamazatlan.com



Survive Your Dream

ECHO Tec Watermakers

604-925-2660

www.hydrovane.com

Partner for Baja Ha-Ha 2013



Tourism Board

www.visitmexico.com



Todo Vela Mexico

BEST SELECTION IN MEXICO!

Harken - Marlow - Ronstan - NE Ropes

Marina Riviera Nayarit - Mercado del Mar #29

La Cruz de Huanacastle - Nayarit - Mexico

(52) 322-105-4840 (cel)

Info@TodoVelaMexico.com



Made from recycled sails, collected from sailing communities all over the world.

We trade bags for sails!

Contact christa@seabags.com
for info on our sail trade program.



Large navy anchor tote,
hand-spliced rope
handles

(207) 415-5104 • www.seabags.com

BROUGHT TO YOU BY THESE OFFICIAL SPONSORS



La Paz Hotel Association
 Welcomes you to La Paz,
 Enjoy our Baja Ha-Ha
 Beach Fiesta
 November the 20th
 011-52 (612) 122-4624
www.golapaz.com

OPEQUIMAR
 MARINE CENTER / CENTRO MARINO

A Full Service Boat Yard in Puerto Vallarta
 88 ton Travelift • Parts • Service • Repairs
 011-52 (322) 221-1800 www.opequimar.com
info@opequimar.com



*Weather, Email and
 Voice Solutions.*

Satellite Phone Sales
 and Rentals.

www.ocens.com
sales@ocens.com • (800) 746-1462

McDERMOTT COSTA
insurance brokers - est. 1938

**CALL FOR
 BAJA HA-HA/
 PACIFIC PUDDLE
 JUMP INFO.**

BILL FOWLER – Marine Specialist
 (510) 957-2012
 Fax (510) 357-3230
bfowler@mcdermottcosta.com

Cruise ROwater.
and power

TECHNAUTICS
 CoolBlue Marine Refrigeration

Go Cruising,
 Not Camping,
 with High Output
 Water Makers,
 Alternators, Wind Gen
 and CoolBlue
 Refrigeration.

www.cruiseROwater.com

IMPORTANT DATES

- Oct. 19 — Ha-Ha Welcome to San Diego Party, Downwind Marine, 12-4 pm. Ha-Ha entrants only.
- Oct. 26 — Pacific Puddle Jump seminar, West Marine, San Diego, 5 pm.
- Oct. 27, 11 am — Skipper's meeting, West Marine, San Diego. Skippers only please.
- Oct. 27, 1 pm — Ha-Ha Halloween Costume Party and Barbecue, West Marine, San Diego.
- Oct. 28, 10 am — S.D. Harbor Ha-Ha Parade.
- Oct. 28, 11 am — Start of Leg 1
- Nov. 2, 8 am — Start of Leg 2
- Nov. 6, 7 am — Start of Leg 3
- Nov. 8 — Cabo Beach Party
- Nov. 10 — Awards presentations hosted by the Cabo Marina.
- Nov. 20, 4-7 pm — La Paz Beach Party. Mexican folk dancing, live music, & more.

See www.baja-haha.com for a list of additional seminars and special events held by our event sponsors.



MARINA DE LA PAZ
FULL SERVICE MARINA
 Conveniently located downtown
 Tel: 011-52 (612) 122-1646
 Fax: 011-52 (612) 125-5900
 email: marinalapaz@prodigy.net.mx
www.marinelapaz.com

*Don't get stuck hand steering—
 Get the reliable, powerful wheel pilot!*



- QUIET AND DEPENDABLE
- AFFORDABLE
- EASY OWNER INSTALLATION
- LOW POWER CONSUMPTION

www.cptautopilot.com 831-687-0541

SAN DIEGO'S RIGGING CENTER
 Proudly serving for over 25 years



**We'll get you ready for your
 next sailing adventure!**

Design consulting • Commissioning • Refits
 Custom line and hardware

WE SHIP RIGGING WORLDWIDE (619)
www.pacificoffshorerigging.com 226-1252

BAJA HA-HA SPONSOR



Vintage Marina Partners
 CHANNEL ISLANDS HARBOR MARINA
www.vintage-marina.com

**Cruise over and spend a night
 at our beautiful Marina**
 Slip reservations, call 805.984.7780
 Located halfway between Malibu and Santa Barbara



**NEW! Western Mexico
 13th Edition with Expanded
 Sea of Cortez Coverage**
www.charliescharts.com

Charlie's Charts

Travel Guides • Gerry's Charts • Ships Store

PLEASE NOTE:
 Correspondence relating to the event can be emailed to andy@baja-haha.com.
 Please don't call *Latitude 38* with questions. The Ha-Ha is a separate operation.

Baja Ha-Ha, LLC
 c/o 15 Locust Avenue
 Mill Valley, CA 94941
WWW.BAJA-HAHA.COM

Please remember to patronize Baja Ha-Ha sponsors.



BAJA HA-HA PROFILES, PT II —

"Who are all these sailors?" you might ask. "And why are they in the *Latitude* spotlight?"

The answer, of course, is that they're members of the 20th anniversary Baja Ha-Ha rally, which begins on the 28th of this month. Giving them their '15 minutes of fame' in these pages is our way of saluting their initiative to cast off their docklines and boldly enter the cruising lifestyle, while many of their dockmates undoubtedly continue to procrastinate.



The 'Sosiego' crew hates Mondays.

We'll pick up where we left off last month with this second installment of fleet profiles, and a final installment will appear in our November edition.

As with the group featured last month, the backgrounds of these entrants are as diverse as the types of boats they sail on. They earn their pay checks doing everything from brain surgery to commercial construction, and some sail aboard modest production boats while others sail gleaming classic yachts.

As in years past, though, the common denominators here are passion for sailing and thirst for adventure. If previous rallies are any indicator, both of those drives will be satisfied during the 750-mile San Diego-to-Cabo San Lucas run, as a typical day of southbound sailing off the Baja California coast features broad reaching with swell and current from astern. As the miles tick away, both air and sea temps get progressively warmer, and game fish get ever more plentiful. No wonder roughly 2,500 boats have done this 'nothing serious' rally since its inception in 1994.

With that introduction to the 'Platinum Edition' Ha-Ha, we'll continue our introductions to the Baja Ha-Ha Class of 2013. (Listed in the order they signed up.)

Dulcinea — Downeast 38

John & Janice Barker, Long Beach

Occupations: John, audiologist; Janice, N/A

Noteworthy: After doing the first Ha-Ha in 1994, John and Janice commuted-

cruised in Mexico for 11 years, plus another three years on the East Coast.

Quote: "It's déjà vu all over again!"

Add'l crew: Al Fricke, plus John & Emily Carpenter

Cruise plans: A few years of cruising in Mexico.

Sosiego — Westsail 32

Joe & Debbie Graham, Alameda

Occupations: Both are registered nurses

Noteworthy: In Spanish *sosiego* means tranquility.

Quote: "Here's to no more Mondays — at least for a year."

Cruise plans: Cruise south to Huatulco, then do a South Pacific circuit.

Pamela — Pacific Seacraft 37

**Dennis Maggard & Pamela York
San Francisco**

Occupations: Dennis, software industry; Pamela, therapist (retired)



'Pamela's crew hopes to reach New Zealand.

Quote: "From the moment I saw the sea, I heard her calling to me, 'Boy, find a boat and come find me.'"

Cruise plans: The plan is to do the Pacific Puddle Jump in the spring, then backtrack from New Zealand in 2015.

Nomad — Rival 36

**Robert Cohn & Margo Louwerse
Pt. Richmond**

Occupations: Robert, N/A; Margo, occupational therapist (both retired)

Quote: "We are using the Baja Ha Ha as a conduit to another life — assuming our relationship stays intact!"

Cruise plans: Continue exploring Baja.



Appa — Wauquiez Centurion 42

**Marcus & Jennifer Reichert
Seattle, WA**

Occupations: Marcus, ER RN; Jennifer, "awesome mother"

Noteworthy: The family is taking a year off to cruise Mexico together before returning to Seattle via Hawaii.

Add'l crew: sons Maxey Albrecht, 16,

The 'Appa' crew is taking a year's sabbatical.





Benjamin Reichert, 8, and daughter Sammy, 3

Cruise plans: Mexico, then home.

Capricorn Cat — Hughes 45 cat
Wayne & Carol Hendryx, Brisbane

Occupations: Wayne, electrician; Carol, teacher (both retired)

Noteworthy: Combining the cruises of the Hendryxes and previous owners Blair and Joan Grinols, 'Cap Cat' has logged

The devilish 'Capricorn Cat' crew.



Spread: The Ha-Ha fleet heads south. *Insets, left to right:* It's great to have a few toys; Turtle Bay volleyball; kids jump for joy.

roughly 95,000 miles.

Quote: "The Ha-Ha is my second favorite thing to do." (Wayne)

Add'l crew: Tony Bezzina, plus Steve & Tawani Swann

Cruise plans: A season of cruising, then bash to the Bay.

Wavelength — Beneteau 46
Sandy & Bill Schwartz, Portland, OR

Occupations: Sandy, flight attendant (retired); Bill, investment adviser

Noteworthy: Sandy once did a cruise from the Marquesas to Hawaii.

Quote: "We're heading south."

Cruise plans: Six to nine months in Mexico.

Sunshine — Saturna 33 PH
Bob Coulson & Dee Dee Brown
Thieves Bay, BC

Occupations: Bob, teacher; Dee Dee, respiratory therapist (both retired)

Noteworthy: Designed by Bill Garden, they call this a baby Fast Passage with a pilothouse.

Quote: "I've been looking forward to this for years!"



Bob and Dee Dee of 'Sunshine'.

Add'l crew: son Gavin Coulson
Cruise plans: No plans.

Ocean Echo — Hallberg-Rassy 45
Hellmuth & Angelika Starnitzky
San Francisco

Occupations: Hellmuth, CEO; Ange-

BAJA HA-HA PROFILES, PT II —

lika, customer service manager (both retired)

Noteworthy: Hellmuth started sailing at age eight.

Quote: "If not now, then when?"

Add'l crew: Hendrick Specht, Betti Kapp, Karin Lotte

Cruise plans: A season in Mexico, then off to Hawaii and Alaska.

Dolce — Island Packet 485

Eric & Gisela Gosch, San Diego

Occupations: Eric, auto dealer; Gisela, N/A

Noteworthy: The couple did the Ha-Ha 10 years ago aboard a similar IP, then cruised the South Pacific and sold her in Australia.

Quote: "We love Mexico and cruising the Sea."

Add'l crew: Chip, Gail & Christopher (son) Polvoorde

Cruise plans: Cruising the Sea of Cortez.



Meet the 'Dolce' crew.

Four Choices — Islander Freeport 36 **Bob Scholl, Westpoint Harbor**

Occupation: engineer (retired)

Quote: "All my other choices were non starters."

Add'l crew: Jim Noble

Cruise plans: A year in the Sea, then on to the South Pacific.

Ilean — Catalina 38

Andy & Eileen McDonough
Alameda

Occupations: Andy, airline pilot; Eileen, CFO (both retired)

Noteworthy: Andy named the boat phonetically after his wife.

Quote: "Out the Gate, turn left; when the butter melts, I'm setting the anchor."

Cruise plans: Open-ended.

Solstice — Island Packet 485

Bruce & Mary Bock, Coronado Cays

Occupations: Bruce, head and neck surgeon; Mary, nurse (both retired)

Quote: "We love Mexico and want this country to flourish. They are a nice, hard-working people with a dedication to visitors and sailors."

Cruise plans: South to Panama, on to Florida, then around the world.

Starshine — Shannon 38

Dave & Gail Kenyon
Deale, MD

Occupations: Dave, aerospace engineer (retired); Gail, contracts manager.

Noteworthy: Dave's sailing career began at age four.



'Starshine' will continue on to the South Pacific.

Quote: "We're a classic, full-keel ketch with even more classic crew."

Cruise plans: Heading to the South Pacific islands and Australia.

Fury — C&C 44

Fred Hazzard, Portland, OR

Occupation: exporter

Noteworthy: This crew has been racing and cruising together for 30 years.

Quote: "Always sail with good friends."

Add'l crew: Denny Damore, Michelle Bennett & John Cole

Cruise plans: Base in La Paz for the winter; bash home in May.

Top Cat — Fountaine-Pajot 37

Rod Goodman, Long Beach

Occupation: electronics engineer

Quote: "It's time to go!"

Add'l crew: Marlene Stewart & John Sears

Cruise plans: Heading to Mazatlan; eventually on to Panama and the Caribbean.

Winterhawk — Beneteau Evasion 36 **Rick & Patti Nordby, Edmonds, WA**

Occupations: Rick, high school shop teacher; Patti, corporate trainer

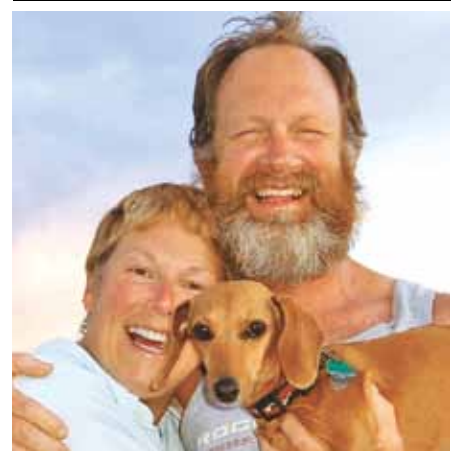

'Winterhawk's crew loves 'messaging about'.

Noteworthy: They are carrying the ashes of their late fisher-dog, and will be spreading some of his ashes whenever they "hook a big one."

Quote: "There is nothing — absolutely nothing — half so much worth doing as simply messing about in boats." (*Wind in the Willows*)

Add'l crew: Jim Richardson & Brian Story

Cruise plans: The boat will be based in Mexico. The couple will winter there.

Whiskey Tango Foxtrot — Beneteau 58 **Reza Malek, Sausalito**

Occupation: drummer

Noteworthy: Launched in 2011, this is one of the newest, and also largest, boats in the fleet.

Quote: "My answer is yes!"

Add'l crew: Miguel Valls, Ali Tavassoli, Ardy Salem, Farzad Maimi & Amir Ayazi

Cruise plans: Bash home again.

Calixto — Hans Christian 33

Ramiro Medina, Marina del Rey

Occupation: human resources

Quote: "Caramba, lets do the Ha-Ha!"

Add'l crew: Stacy Parady

Cruise plans: Truck boat home or hire crew to deliver her.

Scout — 60-ft trawler

John Hartung, Olympia, WA

Occupation: real estate (retired)

Noteworthy: This is one of two Scouts in the rally, the other being a Jeanneau 52.

Quote: "Whatever you can do, or dream you can, begin it."

Add'l crew: Catherine Bartholomew

Cruise plans: Continue cruising in Latin America.

Sea Gypsy — Sea Maid 45

Jon Culver & Jill Ingham

Elfin Cove, AK

Occupations: Jon, military; Jill, N/A

THE PLATINUM EDITION

Quote: "When we bought this boat a year ago the only thing she was capable of doing well was floating."

Cruise plans: A few weeks in the Sea of Cortez, then bash home.

Cerulean — Amel Maramu 46
Jeremy & Erika Hermanns
Marina del Rey

Occupations: Jeremy, VP of marketing; Erika, marketing manager

Quote: "We are super-excited to take *Cerulean* to Mexico and enjoy the weather and laid-back environment with a bunch of like-minded cruisers."

Cruise plans: "Good question!" So many possibilities. . .



Jeremy and Erika of 'Cerulean'.

True North — Hallberg Rassy 36
Gregg & Anne Brickner
Anacortes, WA

Occupations: Gregg, software development; Anne, sales (both retired)

Quote: "We're looking forward to having fun with other folks, exercising our skills, and helping our boat do what she was born to do."

Cruise plans: On to the Caribbean, return home via Hawaii, or possibly ship her back.

Honi — Hunter 33

JD & Jill Mackay, Long Beach

Occupations: JD, pilot; Jill, Realtor (retired)

Quote: "What, me worry?"

Cruise plans: Uncertain.

Antara — Westsail 42

Don Russell & Joyce Goodlatte
San Francisco

Occupations: electrician, retired; Joyce, doctor (retired)

Noteworthy: Don once sailed from S.F. to New Zealand.

Quote: "I have dreamed of sailing off around the world since reading about the *Dove* back in the '60s." (Don)

Cruise plans: Extensive cruising for 5-10 years.

Ebenezer III — Catalina 36
Richard Schaper, Sausalito

Occupation: gift planning officer (retired)

Noteworthy: Both his father and grandfather were commercial fishermen who immigrated from The Netherlands. *Ebenezer* was the name of his grandpa's trawler that fished out of Nantucket.

Quote: "This is what I retired to do — sail the Sea of Cortez, for starters."

Add'l crew: Poul Kjaer

Cruise plans: A stint in the Sea of Cortez, then home.

Green Flash — Beneteau 35
Bob Ritner & Joan Chen
Long Beach

Occupations: Bob, architect; Joan, business manager

Quote: "Preparation and opportunity have finally met."

Add'l crew: Zack Smith

Cruise plans: Base the boat in La Paz or San Carlos, and commuter-cruise for several years.



The 'Green Flash' crew will base at La Paz.

Indigo Star — Tayana 48

Doug & Mary Tracey, Vancouver, BC

Occupations: Doug, operations manager; Mary, executive director

Quote: "Let's not wait until 'tomorrow!'"

Add'l crew: daughter Stephanie & son-in-law Stephen Whiting

Cruise plans: Boat will be based in



The 'Indigo' crew will linger for years.

Mexico for several years.

Happy Dance — Jeanneau DS 43
Marty & Sue McDaniel, Coupeville, WA

Occupations: Marty, manufacturing engineer; Sue, airline system analyst

Noteworthy: Sue has been sailing 37 years longer than her hubby.

Quote: "Years from now you will be more disappointed by the things you didn't do than by the ones you did do. So throw off the bow lines. Sail away from safe harbor. Catch the trade winds in your sails. Explore. Dream. Discover." (Mark Twain).

Cruise plans: This is the beginning of a 20-year cruise.



Alaskans on 'Happy Dance' are eager for sun.

Cool Change — Beneteau 37
John Caletti, Pt. Richmond

Occupation: contractor

Quote: "When you need a break from the grind, it's time to go sailing to Baja!"

Add'l crew: Bill Williams & Theresa Henrekin

Cruise plans: To be determined.

Rose of Sharon — 51-ft schooner
Byron Chamberlain, Newport Beach

Occupation: yacht insurance (and a longtime Ha-Ha sponsor)

Noteworthy: This beautiful Starling Burgess-designed woodie was launched

BAJA HA-HA PROFILES, PT II

in 1930.

Quote: "Looking forward to frivolity, gaiety and competition among old and new friends."

Add'l crew: Kris Rittenhouse, Don Young, Bob Cadranell & Chris Boome

Cruise plans: Head north when the weather is right.

Sea Otter — Island Packet 37 Mike & Julie Dillard, Bend, OR

Occupations: Mike, lawyer; Julie,

medical assistant

Noteworthy: During the seven years they've owned *Sea Otter*, they've done two trips up the outside of Vancouver Island.

Quote: "The Baja Ha-Ha will be the start of our family's sailing adventure of a lifetime."

Add'l crew: son Ben Dillard, 12, and Julian Munoz

Cruise plans: A season in Mexico, then will probably do the Pacific Puddle Jump.

A Good Day — Island Packet 485 Charlie McCullough San Francisco

Occupation: tech exec

Noteworthy: In addition to other sailing, Charlie and his wife Carol have been chartering boats for 30 years.

Quote: "An East Coast sailor boldly takes on the Pacific!"

Add'l crew: TBD

Cruise plans: The boat will eventually be based at Puerto Vallarta.

Kalewa — 50-ft custom cat Kevin & Marcie Millett, Nawiliwili, HI

Occupations: Kevin, boat builder; Marcie, self-employed

Noteworthy: The owners built this boat themselves and did the 2008 Ha-Ha. The name's pronounced Ka le va.

Quote: "It doesn't get any better than this."

Cruise plans: "Who knows?"

Sagacious — Columbia 50 Chris Geddes, Dartmouth, GBR

Occupation: crash test engineer (re-

BHH SPONSORS

We encourage you to support these BHH sponsors. Without them, there would be no Ha-Ha.

Almar Marinas www.almar.com; **Blue Latitude Press** www.bluelatitudepress.com; **Charlie's Charts** www.charliescharts.com; **Commander's Weather** www.commandersweather.com; **Cruise RO Water and Power** www.cruiseROwater.com; **Downwind Marine** www.downwindmarine.com; **Harbor Island West** www.harborislandwest.com; **Hydrovane** www.hydrovane.com; **ICOM America, Inc.** www.icomamerica.com/marine; **La Paz Hotel Association** www.visitlapaz.org; **Latitude 38 Magazine & 'Lectronic Latitude** www.latitude38.com; **Marina de La Paz** www.marinadelapaz.com; **Marina El Cid** www.elcid.com; **Marina Mazatlan**

www.marina-mazatlan.com; **Marina Puerto de la Navidad** www.islanavidad.com.mx; **Marina Riviera Nayarit** www.marinarivieranayarit.com; **Mariner's General Insurance Group** www.marinersins.com; **OCENS** www.ocens.com; **Opequimar Marine Center** www.opequimar.com; **Pacific Offshore Rigging** www.pacificoffshorerigging.com; **Paradise Village Marina** www.paradisevillage.com; **Quickline USA** www.quickline.us; **Rigging Only** www.riggingandhardware.com; **Scanmar International** www.selfsteer.com; **Sea Bags** www.sea-bags.com; **Todo Vela** www.TodoVelaMexico.com; **Vallarta Yacht Club** www.vallartayachtclub.org; **Vintage Marina Partners** www.vintage-marina.com; **Waypoint** www.waypoints.com; **West Marine** www.westmarine.com



*Call About Our
Special
Cruiser Rates!*

San Diego's Cruiser Destination

Harbor Island West Marina

620 Single Slips
Outstanding Central Location
Complimentary Wifi
Fuel Dock

Pool/Spa/Laundry
Deli & Restaurant
Package/Mail/Fax/Notary

619.291.6440

www.harborislandwest.com
2040 Harbor Island Drive San Diego, California 92101

THE PLATINUM EDITION

tired)

Noteworthy: Previous owner sailed her twice to Australia, and she did at least one TransPac.

Quote: "This is the kick up the backside I need to get me started on my journey."

Add'l crew: Robert Daniel

Cruise plans: Wintering in La Paz; eventually on to Indonesia and Singapore.

**Ahmeek — Celestial 48
Dennis Gray & Sherie Gibson
Utah**

Occupations: Dennis, engineer; Sherie, teacher (both retired)

Noteworthy: The entire crew is from the land-locked mountain state of Utah, and has much more experience in skiing than sailing.

Quote: "Seems like a great way to end up in the Sea of Cortez knowing some friends in the area."

Add'l crew: Michael & Melissa Skarsten

Cruise plans: Cruise Mexico for a year or two.



The 'Ameek' crew is up for a change of altitude.

**Sailors Run — Baba 40
Jeff & Debbie Hartjoy, Longbranch, WA**

Occupations: Jeff, utility lineman; Debbie, homemaker (both retired)

Noteworthy: The couple has cruised this boat extensively including two Ha-Has, and Jeff soloed 5,600 miles from Lima, Peru, to Buenos Aires, Argentina.

Quote: "Time is the currency of life, so let's go spend some."

Add'l crew: adult son Dan
Cruise plans: Open-ended.

**Gatecrasher — Tayana 48DS
Roger Shortz, San Francisco**

Occupation: neurosurgeon

Quote: "I have been putting this off for several years, but I'm finally going to chuck it all and do this thing. I even got a tattoo (my first) for the event!"

Add'l crew: Tom Mansor

Cruise plans: Heading on to new home in Guayabitos.

Since our keyboard is groaning and we've run out of space, we'll take a break here. But next month we'll introduce you to the rest of the fleet, some of whom waited until the last minute to pull the trigger. And in the December edition you'll find a complete recap of the event, from pre-start to finish.

In the meantime, look for on-the-scene event reports on our thrice-weekly online newsletter, *Electronic Latitude*, at www.latitude38.com.

— **latitude**/andy



Save Your Aft!

Using one of our 1900+ patterns or your own pattern, let our craftsmen create a comfortable, durable, and stylish set of all-weather cushions for your cockpit. Find your custom, closed cell foam cushions at www.bottomsiders.com!

BottomSiders

BottomSiders
2305 Bay Avenue
Hoquiam, WA 98550

Call Toll Free: (800) 438-0633
cushions@bottomsiders.com
Fax: 360-533-4474



Climb Your Mast Alone with Mast Mate
Made in the USA for 27 Years

Satisfaction Guaranteed

(207) 596-0495

www.mastmate.com



BAJA HA-HA
SAIL SERVICE
BEFORE MEXICO

Use Ullman Sails for your last minute Repairs and Service needs before the **Baja Ha-Ha**.

★ Don't forget, we'll pick up your sails for free from local marinas!

(619) 226-1133
2805 Canon St
San Diego, CA 92106

MAX EBB

"*Mayday! Mayday! Mayday!* Calling the Coast Guard!"

At some point in the distant past history of my yacht club, someone decided there should be a VHF marine radio in the bar. On rare occasions it actually proves useful, for example when someone radios ahead for a dinner reservation or when a club member's boat is aground on the sand bar and one of the crew has opera tickets. Mostly it's just annoying background noise, but the *mayday* call got our attention. The conversation stopped immediately so we could hear what was about to unfold.

"Vessel calling *mayday*," said a young but very serious voice from the radio, "this is Coast Guard Sector San Francisco. What is the nature of your distress?"

"*Mayday!* Calling the Coast Guard! We have lost power!"

The sailor on the next bar stool looked over at me and I looked at him, and we both rolled our eyes. But we felt compelled to eavesdrop on every word of this exchange.

"Vessel calling, Coast Guard Sector San Francisco. Are you in immediate danger?"

"*Mayday!* Calling Coast Guard! Yes, we are drifting and we need a tow."

"Vessel calling, Coast Guard Sector San Francisco. What is your location?"

"We are off the Naval Air station, and have no power. Repeat, we have no power."

"Vessel calling, Coast Guard Sector. Are you in immediate danger?"

"*Mayday!* Coast Guard! We are a half mile off the Naval Air Station, drifting with no power."

The patient voice of the Coast Guard became a little less patient, but still needed to get a more exact position.

"Vessel calling, Coast Guard Sector San Francisco. Can you give me a GPS position?"

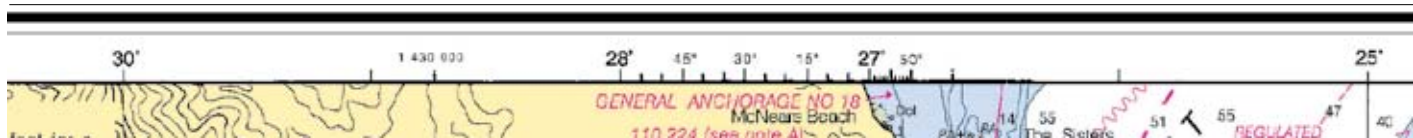

"*Mayday!* Coast Guard, we are about a half mile southwest of the end of the runway at the Naval Air Station. We are between two buoys — I think they are number one and number two."

But the Coast Guard apparently had no idea where that was. He kept asking for a position in latitude and longitude, and the drifting powerboat — we all assumed it was a powerboat — did not have a GPS and was not able to describe their

location using any other landmarks.

"The problem," observed one of the sailors at the bar, "is that the Naval Air Station probably shut down before that kid in the Coast Guard radio room was born."

"Maybe we can help," I suggested. "Let's pull the latitude and longitude off the chart on the wall."

About four of us ran over to the framed copy of chart 18649 — 'Entrance to San Francisco Bay' — that had been hanging on the wall next to the bulletin board in the hallway for as long as anyone could remember. On the way, I barely avoided a collision with Lee Helm, coming from the direction of the women's bathroom. Her hair was wet, and she was carrying a small sea bag and a dripping wetsuit. She's not a yacht club member, but she has a habit of sneaking in to use the shower after windsurfing.

"Starboard tack," I said, since she had come from my left and caused me to alter course. "And fancy meeting you here. Are you a guest of a member, or have you finally decided to join?"

"The showers here are, like, so much nicer than those grungy marina bathrooms," she explained, more to the other yacht club members who might not be as familiar with her M.O.

"Well, at least sign in and fill out a name tag," I insisted. "You can be my guest this time, but you really shouldn't sneak in without being invited first."

"Hey, future members have rights here too," she reminded me.

Meanwhile two of my friends were trying to determine the latitude and longitude of the stricken vessel by reading the chart. "There are only tick marks for latitude every minute of arc," complained

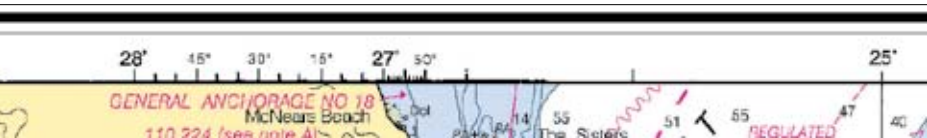

The longitude scale along the top of chart 18649. Transfer the distance from the nearest minute meridian to the subdivided interval, then divide by 60 to convert to decimal minutes.

one of the volunteers. "They must be a mile apart, with nothing in between. How can we get a precise latitude with no subdivisions on the margin?"

"Use the edge of this membership application," said another helper, grabbing the closest piece of paper at hand.



An accident such as this is an appropriate time to call a 'mayday'. Losing your engine when you're far from danger may not be.

"Mark the distance up from the nearest parallel and then compare to the place where there's a graduated scale on the margin."

"Damn, it's in minutes and seconds," said the first volunteer. "Who uses seconds these days, anyway?"

"Latitude is the same as the nautical miles scale," said the other sailor, apparently the one with the better knowledge

of charts and navigation. "That's calibrated in tenths."

They found longitude to be more difficult because the miles-scale didn't work, and while one volunteer was dividing seconds of arc by 60 to get decimal minutes, Lee had sneaked over to the member computer terminal, hacked a password, brought up Google Earth, changed the



LATITUDE / RICHARD

setting to degrees and decimal minutes, and had the coordinates of the spot in question at about the same time that the people struggling with the framed chart and the strips of paper had the numbers.

"It's hard enough to get lat-long off a paper chart when I'm sober," said one of the sailors. "How in heck is anyone supposed to do this after two hours of drinking at the bar?"

Meanwhile the VHF drama continued: "Vessel calling, Coast Guard Sector San Francisco. Do you have an anchor on board?"

"We'll check, please hold."

This was our opportunity. I picked up the mic, said "Break break," and reported the coordinates of the spot a half-mile off the southwest corner of the old Naval Air Station, between buoys one and two.

The Coast Guard thanked me, but also requested that we keep the channel clear.

"I guess the format of that chart was set long before we had gadgets that spoke latitude and longitude," I surmised. "A hundred years ago there was hardly ever any reason to report an inshore position as a latitude and longitude."

"Still, you'd think that would be fixed by now," complained one of the more inebriated sailors, now back at the bar with yet another Tanqueray and tonic in front of him. "And that Coastie. Can't they find someone who knows the Bay a little better?"

I remember listening in one time when a boat was on fire right in Hospital Cove, and the kid on the Coast Guard radio didn't even know where that was."

"Oh, come on," I said in defense of public servants. "They do a great job."

"But the voice on the radio," added Lee, "is the public face of the Coast Guard, and you'd totally think they'd go

to a little more trouble to find someone who knows the common landmarks on the Bay. I mean, it's just basic PR."

"She's got a point," said one of the other sailors as he contemplated his martini.

The discussion paused so we could eavesdrop on more VHF chatter, as the Coast Guard tried to ascertain the length and description of the vessel.

"We are a Tartan Ten," said the voice from the crippled boat.

We were all surprised it was a sailboat, but considering our analysis of the crew's skills up to that point, not really surprised that they couldn't sail it home. After all, it was a calm fall afternoon and the wind in the South Bay was probably less than five knots.

The Coast Guard asked again for the boat's length and description.

"Oh, come on," said Lee. "Ten meters. It's a 33-ft sailboat with a flush deck and fractional rig. That guy on the radio must be from Nebraska."

Eventually that information was conveyed, but the next thrash involved getting the boat's name spelled correctly. Every time the Coastie asked for the vessel's name, the boat responded with "Mayday!" until it was finally understood that "Mayday!" was actually the boat's name.

"This one is the boat owner's fault," Lee allowed. "Gotta be the stupidest boat name ever. But lesser offenses can still cause problems: Never choose a boat name that's hard to spell, that's an obscure foreign language word, or that reads as a bad pun."

Eventually the description of *Mayday!* was established. Eventually it was established that *Mayday!*'s anchor was down and holding, and eventually it was established that everyone on board *Mayday!* had put on a life jacket.

With a little more trouble they eventually negotiated a switch away from channel 16, but we were cheated out of hearing the discussion because they then switched to their cell phone before we could listen in on the inevitable message that, no, the Coast Guard was not going to tow them to their marina, and that they would have to hire a commercial towing service if they needed to get home quickly.

**"Mayday! Mayday!
Mayday! Calling the
Coast Guard!"**

"Show's over," said the bartender as he switched the radio back to 16.

MAX EBB

"All stations, all stations, all stations," crackled the radio through some static a few minutes later. "This is United States Coast Guard Sector San Francisco, United States Coast Guard Sector San Francisco, United States Coast Guard Sector San Francisco, United States Coast Guard Sector San Francisco. Be advised of an anchored obstrcokakayg located near channel marker two at the brlzigls chiolwgohg channel. All mariners are advised to proceed with caution. This is United States Coast Guard Sector San Francisco, United States Coast Guard Sector San Francisco, United States Coast Guard Sector San Francisco, out."

"I love the way they repeat that they're the Coast Guard three times coming and three times going," complained Lee, "but the one bit of info that might actually be, you know, important, is only said once and when there's some static or distortion at that instant you're out of luck."

"It's just standard radio protocol to repeat the name of your station three times," said the radio expert. "Can't blame them for using proper procedures."

"Total waste of bandwidth," Lee argued. "I mean, anyone can parse 'Coast

Emergency Radio Procedures

- Determine if you and/or your vessel are in *immediate danger*, (sinking, on fire, about to go on the rocks, etc.). If so, proceed with the following. If not, call Vessel Assist.
- Speak slowly, clearly & calmly.
- Say "*Mayday, mayday, mayday*. This is (*vessel name repeated three times*). Over."
- State your location — preferably lat & long — twice.
- State the nature of your distress, number of people onboard and if there are any injuries, the condition of the vessel, and the type of assistance you need.
- The Coast Guard will need to know your vessel length, type and color, as well as if you have enough PFDs aboard.

Guard Sector San Francisco' even through heavy static. It's the actual message that needs to be repeated. All that repetition of the obvious just makes them sound silly."

"Well, at least we got that it was near channel marker number two," I pointed out, with more than a little sarcasm. "That really narrows it down."

"Yeah, but give the chartmakers a break. The buoy numbering system predates radio communications by a couple of centuries," noted the navigator at the other end of the bar. "Within shouting distance, the buoy numbers are unambiguous."

"Shouting distance," Lee repeated. "Ya think maybe it's, like, time to modernize?"

"Nah," said the drunk from the next bar stool. "The documentation alone would cost millions, never mind the paint. I'll have another rum and Coke, please."

"Those Coast Guard radio kids also seem to have trouble plotting bearings on a chart," added the navigator at the other end of the bar. "Once I watched a boat

Call or email Pam deWitt
for pricing on
Original Paintings
as well as
Giclée Prints.

DeWitt Art Gallery & Framing

(510) 236-1401 • pam@jimdewitt.com

www.DeWittAmericasCupArt.com

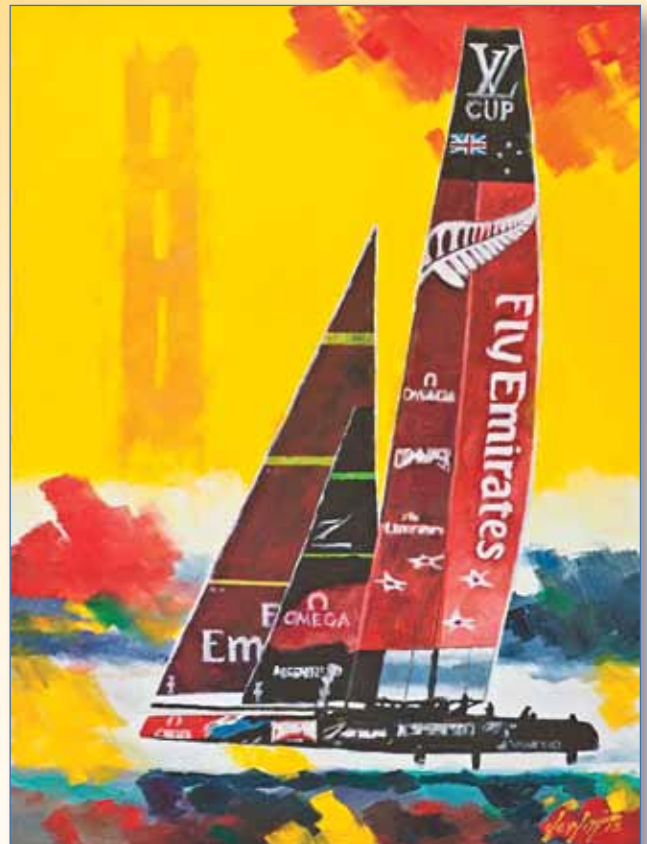

Pretty strong racing by ETNZ!

sink, some distance outside the harbor. Everyone was taken off okay by another boat, and just the mast was marking the spot. I called it in on my cellphone, and as usual they wanted latitude and longitude."

"I remember that one," said the most drunk club member. "That was me who picked up that crew in my Whaler."

"All I had was my cell phone, and I was on shore and some distance from the scene. So I lined them up with a day mark and background landmark, then walked to the end of the breakwater and lined them up with another landmark. So I gave the guy two really good bearings with a decent crossing angle."

"And he still wanted a lat-long, right?" I guessed.

"The guy couldn't draw two lines on a chart. Or on his computer screen. Anyone who passed the Coast Guard auxiliary navigation class with a B-minus could have done that. But not that guy on the radio."

"I guess he had to follow his script," I said. "But still"

Nothing else of interest came over the radio for some time, except the usual calls for a radio check, answered with "Coast Guard Sector San Francisco. Be advised that radio checks are conducted on channel nine."

"Now there's a losing battle," said my inebriated friend. "We're supposed to use 9, not 16, for calling. Do you actually know anyone who does that? Or who listens on channel 9 instead of 16?"

"Not me," admitted almost every sailor at the bar.

"Don't you swabs know how to use dual watch?" asked the navigator, who was also the one person who did claim to monitor channel 9. "Virtually every radio has it, and it's really simple to set up."

"My research shows that 88.5% of all recreational boaters who own a dual-watch VHF have never used it in dual watch mode," announced Lee, citing a new made-up statistic.

"And my research," I responded,

"shows that 91.7% of all race crew who own a countdown stopwatch don't know how to set it to count down to a race start."

"Well, my research shows that 94.1% of all VHF calls originate on 16, not on 9," said the drunk sailor. And to prove it, he switched the radio to channel 9.

The radio was silent for some time, so we eventually went back to 16. And not a moment too soon. There was a boat on the rocks, already with some hull damage and taking water, with an injury on board. We heard the latitude and longitude transmitted.

"That's right outside the harbor!" shouted Lee. "Let's go!"

We stumbled out of the bar like a fire brigade in a Keystone Cops movie, ran down the road to the rocks by the harbor entrance, and got there just in time to see a Coast Guard RIB pulling up alongside and tossing a towline.

"When all is said and done," admitted the drunk, "those guys are great."

"I guess," sighed Lee. "But in a totally old-school kind of way."

— max ebb

STS
STRONGER THAN STEEL

HSR – Heat-Set Rope

- Lowest Constructional Elongation!
- Superior Strength!
- Ultra Low Stretch!

Dyneema

NEW ENGLAND ROPES
TOGETHER IN MOTION

THE RACING

September wasn't all about the America's Cup, but it certainly took a bite out of the normal racing season. Still there was plenty to occupy local racers. Check out some of the action below, plus more **Box Scores**.

Express 27 Nationals

The Express 27 Nationals, hosted by Richmond YC on August 23-25, were all about bullets. PRO Fred Paxton ran out of them. And those shotgun shells would have announced to the competition that his son, Will Paxton, had won yet another race aboard *Motorcycle Irene*. All told, Will won six of the seven races and got short-changed maybe four shotgun blasts.

"Practicing really paid off," says Will. And with crew Zach Anderson, Parker Mitchell and bowchick Sherry Smith, he says, "It was fun."

The only race lost in an otherwise unblemished bunch of aces came at the helm of Dan Pruzan's *Wile E Coyote*, which took a long-distance race flier from Red Rock to current relief on the Marin shore. It was the right thing to do.

Daddy Paxton — watching the course with paternal interest — was at times critical of his son's not covering the competition. And he's still wondering who found his secret stash of shotgun shells on the committee boat.

— ryc race committee

EXPRESS 27 NATIONALS (8/23-25; 7r,0t)

OVERALL — 1) **Motorcycle Irene**, Will Paxton/Zach Anderson, 8 points; 2) **Get Happy!!**, Brendan Busch, 18; 3) **Wile E Coyote**, Dan Pruzan, 22; 4) **Magic Bus**, Paul Deeds, 31; 5) **Peaches**, John Rivlin, 36; 6) **El Raton**, Ray Lotto, 56; 7) **Opa!**,



Will Paxton, Parker Mitchell, Zach Anderson and Sherry Smith earned the National Championship trophy and the Owner/Driver trophy.

Peggy Lidster, 56; 8) **Tequila Mockingbird**, Matt Krogstad, 57; 9) **Summer Palace**, Wolfgang Stehr, 65; 10) **Monster Express**, Ted Lohr, 68. (15 boats)

Complete results at www.express27.org

RYC Intra-Club Race

While running the Express 27 Nationals — aka The Will Paxton Show — over

on the Circle on August 24, Richmond YC also found time to squeeze in a club members' 12-mile pursuit race around Southampton and the Brothers. The Grand Dame of Bay sailing, Jocelyn Nash, ran the race, which featured Spinnaker and Non-Spinnaker divisions. The former, which boasted 26 boats, was won by Wayne Koide and crew on the Sydney 36 *Encore*. Ralf Morgan and Debra Clark on their Alerion Express 27 *Ditzy* beat out 15 other non-spinny boats for the win.

— ryc race committee

RYC INTRA-CLUB PURSUIT RACE (8/24; 4r,0t)

SPINNAKER — 1) **Encore**, Sydney 36, Wayne Koide, 8 points; 2) **Mach Schnell Kleiner Hase**, Wylie Wabbit, Erik Menzel, 21; 3) **Lilith**, Wyliecat 39, Tim Knowles, 21; 4) **Baleineau**, Olson 34, Charlie Brochard, 21. (26 boats)

NON-SPINNAKER — 1) **Ditzy**, Alerion Express 28, Ralf Morgan, 11 points; 2) **Dreamt**, Alerion Express 28, Kirk Smith, 26; 3) **Skip•purr**, Catalina 30, Steve Kittle, 28. (16 boats)

Complete results at www.richmondyc.org

SBYC/BenYC Jazz Cup

"Goose wins the Jazz Cup." It's almost as obvious a headline as that one from *The Onion*, "Rich Guy Wins Yacht Race." The Kastrop family's South Beach YC-based Catalina 30 has won the funky trumpet trophy six times now, including three times in a row. This time they had to do it without the help of their now-grown sons, so it was a bittersweet victory. Overall trophies also went to Dan Alvarez's JS9000 *JetStream* (monohull) and Jerome Ternynck's *Extreme 40 cat SmartRecruiters* (multihull).

Meanwhile, a different Goose — Goose Gossman — reports having had a blast during the South Beach YC and Benicia YC-sponsored race on August 31 aboard Steve and Ginger Penny's Hunter 386 LE *Windfall*. "A couple of AC72s buzzed the start off Treasure Island, which was cool," Goose says. "This was the Pennys' first race ever and the first time flying their new asymmetrical spinnaker. Since I was the only experienced racer on the crew — which included German exchange student Felix and his host Alex, as well as Benicia wa-



termen Joe Miller — I assumed the role of tactician.

"As we approached a mark on starboard, we were forced into an emergency bear-away to avoid a collision. I casually informed the other boat of their offense but we chose not to file a protest — which would almost certainly have led to their being disqualified — as that would only have distracted us (and them) from the fine sailing ahead. In fact, it's my understanding that there was a heated, several-hour protest concerning this mark, which resulted in the disqualification of two boats. In my opinion, this kind of stuff really detracts from the fun of the competition of a great race."

— latitude / chris

JAZZ CUP (8/31)

DIVISION D — 1) **Alegre**, Santana 22, Chris Klein; 2) **Wind Pacer**, Capri 22, Carole Vaillancourt; 3) **Four Sirens**, Santana 20, Will Deutsch/Mark Werder. (8 boats)

DIVISION E — 1) **Goose**, Catalina 30, Mike & Lorianna Kastrop; 2) **Adventure**, Catalina 30, Jack McDermott; 3) **Time Bandit**, J/22, Scott Mack. (8 boats)

DIVISION F — 1) **Ruby**, Moore 24, Steve McCarthy; 2) **TMC Racing**, J/24, Michael Whitfield; 3) **Downtown Uproar**, J/24, Darren Cumming. (10



GOOSE GOSSMAN

Nespresso 18-ft Skiff International Regatta

Last month's Nespresso 18-ft Skiff International Regatta for the Mark Foy Trophy, hosted by St. Francis YC, turned into a clash between two Kiwi teams, Alex Vallings' *C-Tech* and David McDiarmid's *Yamaha*. None of the other 20 skiffs came close. A cliffhanger, the regatta went down to the tenth and last race on September 13. "We had to win," Vallings said. "Halfway down the run we were third, but *Yamaha* was behind us the whole race."

The highlight of the week for second-place McDiarmid was his class win in the Ronstan Bridge to Bridge, a counter for the regatta, on Thursday. But Marin-based kiteboarding phenom and 2012 Rolex Yachtsman of the Year Johnny Heineken really wowed in the September 12 event, foiling his board 5.3 miles from the Golden Gate to the Bay Bridge. He finished in an amazing 12 minutes, taking 2 minutes off the course record.

Johnny's kiteboarding sister Erika was the first female, coming in eighth. Looming over the competition and finishing in fifth place was Tom Siebel's MOD 70 *Orion*. The Bay Area's Mike Percey was the winning windsurfer.

— latitude / chris

StFYC/NESPRESSO 18-FT SKIFF INTERNATIONAL REGATTA (9/8-15; 10r,2t)

OVERALL — 1) **C-Tech**, Alex Vallings/Josh McCormack/Chris Kitchen, NZL, 11 points; 2) **Yamaha**, David McDiarmid/Andrew Archibald/Mark Overington, NZL, 11; 3) **Fisher & Paykel**, Grant Rollerson/Glenn Raphael/Pistol Nicholson, AUS, 26; 4) **Yandoo**, Nick Press/James Beck/Andrew Hay,

For more racing news, subscribe to 'Lectronic Latitude online at www.latitude38.com.

September's racing stories included:

- AC 34 • Red Bull Youth America's Cup
- Hannig Cup • Windjammers • Jazz Cup
- IKC • Totally Dinghy • Melges 20 NAs
- EYC Beer Cans • Melges 32 Worlds
- Ultimate 20 NAs • Multihull Invitational
 - U.S. Multihull Championship
 - U.S. Singlehanded Championship
 - U.S. Match Racing Championship
 - 18-ft Skiff International Regatta
- Ronstan Bridge to Bridge • Barth Race
 - Shields Trophy • Charity Regatta
 - Previews for Superyacht Regatta, NYYC Invitational, ABYC OCR, Vallejo 1-2, Patriot Regatta, Rolex Big Boat Series, Oktoberfest, Vanguard 15 Fleet Champs, Vic-Maui, SF Bay Folkboat Regatta, 49er Worlds, and much more!

boats)

SF30s — 1) **Heart of Gold**, Olson 911S, Joan Byrne; 2) **Tartanic**, Tartan Ten, Robert Lanzafame; 3) **Bay Loon**, J/29, Grant Harless. (8 boats)

DIVISION H — 1) **Arcadia**, Mod. Santana 27, Gordie Nash; 2) **Shenanigans**, Express 27, Bill Moore; 3) **Highlighter**, Islander 36, William Hackel. (12 boats)

DIVISION J — 1) **Hoot**, Olson 30, Andrew Macfie; 2) **Sir Leansalot**, Hunter 40, Tom Lueck; 3) **E Ticket**, Moorings 38, Noble Griswold. (11 boats)

DIVISION K — 1) **Yucca**, 8-Meter, Hank Easom; 2) **Savoir Faire**, Beneteau First 42, Paul Osborn; 3) **Red Cloud**, Farr 36, Don Ahrens. (9 boats)

SPORTBOATS — 1) **JetStream**, JS9000, Daniel Alvarez; 2) **Rusalka**, Melges 24, Zhenya Kirueshkin-Stepanoff; 3) **Flight Risk**, Thompson 650, Ben Landon. (8 boats)

DIVISION Q — 1) **Twisted**, Farr 40, Tony Pohl; 2) **Bodacious+**, 1D48, John Clauser; 3) **Tupelo Honey**, Elan 40, Gerard Sheridan. (9 boats)

MULTIHULLS — 1) **SmartRecruiters**, Extreme 40, Jerome Ternynck; 2) **HMB Boys & Girls Club**, D-Class cat, Alan O'Driscoll/Bryan Wade; 3) **Rocket 88**, Spruitt D-Class cat, Ian Klitza. (12 boats)

JAZZ CUP TROPHY: **Goose**

FIRST OVERALL MONOHULL: **JetStream**

FIRST OVERALL MULTIHULL: **SmartRecruiters**

Complete results at www.southbeachyc.org

U.S. Multihull Sailing Championship

AC72s weren't the only cats wowing

the crowds along the Cityfront last month. On September 7, 21 Hobie 16s shared the limelight in US Sailing's Multihull Championship, hosted by Sausalito YC. The teams were introduced to the shoreside spectators, who cheered them on as they raced close to shore.

Enrique Figueroa and crew Carla Malatrasí of San Juan, Puerto Rico, continued their dominance with four more wins en route to claiming the title. Two (mostly) Californian teams battled it out for second: France's Andy Dinsdale and Sacramento's Heather Mathews clinched it by two points over Long Beach's Jeffrey Newsome and Michelle Eatough. The Bay Area's Adam Borcharding (Santa Cruz) and Jacob Sailer (Alameda) finished eight points back.

US SAILING U.S. MULTIHULL CHAMPIONSHIP (9/4-7; 12r,1t)

OVERALL — 1) Enrique Figueroa/Carla Malatrasí, 11 points; 2) Andy Dinsdale/Heather Mathews, 54; 3) Jeffrey Newsome/Michelle Eatough, 56; 4) Adam Borcharding/Jacob Sailer, 62; 5) Mike Montague/Kathy Ward, 66; 6) Patrick Porter/John Williams, 71; 7) Rich McVeigh/Carol Hilck, 83; 8) Sarah Newberry/Emmett Moore, 85; 9) Ben Brown/Andrew Wilkinson, 112; 10) Blair Wallace/Sasha Wallace, 117. (23 boats)

Complete results at <http://championships.usailing.org/Adult/USMHChampionship.htm>

THE RACING

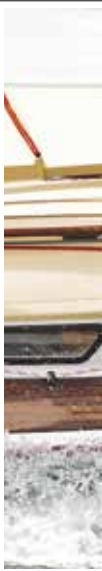

Knarrly— Since sailors switched boats every day, there's no sense in IDing these gorgeous Knarrs. Instead, enjoy the beautiful photos by Leslie Richter.

AUS, 31; 5) **CST Composites**, Howard Hamlin/Matt Noble/Paul Allen, USA, 32. (22 boats)
Complete results at www.18skiff.com

International Knarr Championship

On the sixth and final day of racing in the 45th International Knarr Championship (IKC), hosted by San Francisco YC, Denmark's Soren Pehrsson sailed away with the win. San Francisco's Jon Perkins was close on his heels, with IKC defending champion Lars Gottfredsen (DEN) rounding out the podium. The founding father of the San Francisco Bay Knarr fleet, Knud Wibroe of Sausalito, took sixth.

Conditions were windy throughout the week, which made for tight racing on the Olympic Circle and the Cityfront. Twenty-eight teams from Norway, Denmark, Germany and the Bay Area participated, with local skippers providing their lovingly cared-for boats so international skippers would not have to go to the expense of shipping theirs. Skippers switched boats every day, making the regatta as fair as possible.

Next year's IKC will be held in Bergen, Norway. The event will return to the Bay in three years.

INTERNATIONAL KNARR CHAMPIONSHIPS (8/30-9/7; 10r.2t)

OVERALL — 1) Soren Pehrsson (DEN), 18 points; 2) Jon Perkins (USA), 31; 3) Lars Gottfredsen (DEN), 34; 4) Tom Carlsen (DEN), 36.5; 5) Kim Bruhn-Petersen (DEN), 49; 6) Knud Wibroe (USA), 50; 7) Phillip Perkins (USA), 51; 8) Don Nazzal (USA), 65; 9) Brent Crawford (USA), 72; 10) Graham Green (USA), 78. (27 boats)

Complete results at www.sfbayknarr.com

Shields Trophy Regatta

Vallejo's California Maritime Academy (CMA) tied for first in the Shields Trophy Regatta at the U.S. Naval Academy in Annapolis last month. Ten teams turned out for the 9/21-22 competition between service and maritime schools and sailed in the Academy's fleet of Navy 44s.

Chesapeake Bay offered up challenging conditions on the first day, with a building southerly wind and unusually large waves and chop. Navy jumped out to a quick lead, winning the first race and a close second in race #2. CMA started slowly with a 2.4 but came on strong to win the final two races of the day.

After the first two races the wind was gusting into the mid-20s. With equipment preservation in mind, the race committee

opted to restrict sail selection to #3 jibs and no spinnakers for the final two. This put a huge premium on starts and upwind boat handling. At the end of the day, CMA was in first, with Navy one point behind.

With the cold front having passed, conditions for day two were typical, with NNW winds starting in the high teens. The breeze dropped, and Navy elected to change to a bigger headsail downwind, which proved decisive as they passed Coast Guard and CMA to take the win.

For the second race, CMA nailed the pin and worked the favored left side while Navy found themselves buried after the start. CMA went wire to wire for the win as Navy scratched back to a fifth, just nipping Maine Maritime at the finish.

For the final race, CMA was sitting on a three-point lead but were no doubt nervous given the fluky conditions. SUNY Maritime won the pin end of the line with Navy safely to windward, while CMA couldn't fetch the pin due to the building ebb. SUNY went up and down in the lead, with Navy in second, and CMA back in sixth, forced left outside a number of



ALL PHOTOS LESLIE RICHTER / WWW.ROCKSKIPPER.COM

boats. Navy stayed in phase to slip past SUNY and rounded the last weather mark well ahead. CMA did not give up, passing two boats, but, in the end, it wasn't enough. Navy held the tiebreak which ended up being the deciding factor.

Congratulations to Cal Maritime's Keelhaulers: Dillon Lancaster, Scott Doyle, Harry Antrobus, Andrew Lamb, Chris Vilich, Ryan Lynch, Corey Lynch and Eileen Welch.

— charlie arms

SHIELDS TROPHY REGATTA (9/21-22)

OVERALL — 1) **U.S. Naval Academy**, 16 points; 2) **Cal Maritime Academy**, 16; 3) **U.S. Merchant Marine Academy**, 29; 4) **SUNY Maritime College**, 30; 5) **Massachusetts Maritime Academy**, 31; 6) **U.S. Coast Guard Academy**, 37; 7) **Maine Maritime Academy**, 49; 8) **Royal Military College**, 52; 9) **St. Mary's College of Maryland**, 62; 10) **U.S. Military Academy**, 64. (10 boats)

Complete results at www.collegesailing.org

Catalina 38 Nationals

Five boats turned out for the Catalina 38 Nationals, hosted by Berkeley YC on August 31. Nuking late-summer winds offered up challenging conditions on the

Bay but Mike Mannix's *Harp* nailed the first race, crossing the line 30 minutes ahead of anyone else. The remaining boats all finished four minutes apart. The second race took the fleet to Alcatraz and through Raccoon Strait into the lee of Angel Island. *Harp* found the wind and once again took the win.

Until this year, the regatta was normally held in Long Beach. Next year it will travel to Puget Sound.

CATALINA 38 NATIONALS (8/31)

OVERALL — 1) **Harp**, Mike Mannix; 2) **Thira**, Ray Torok; 3) **Pretty Lady**, Dave McCarty; 4) **Enfin**, Bob Kirby; 5) **Little Breeze**, Kerry Grimes. (5 boats)

More info at www.catalina38.org

Weta West Coast Championship

The Weta West Coast Champs, held September 21-22 as part of Richmond YC's Multihull Invitational, was good fun, with great race management by the women's Byte fleet on a tricky tidal and shifty race course. The course offered great — although sometimes distracting — views of the America's Cup racing.

Saturday dawned light and shifty and Sunday started the same, but the breeze built through the day. Everyone was sitting out on the ama upwind, but

downwind the heavier crews found life more difficult in the lighter breezes.

Chris Kitchen dominated the racing, making most of his gains downwind and in the starts. Kitchen's take on the regatta was all positive. "The buzz was just so fun, everyone was smiling and enjoying themselves, no matter how they ended up in the fleet," he said.

Sunday was windier than Saturday, and Jonathan Weston started to get his form going, taking a race off Kitchen and a second in the last race. But it wasn't enough to stop Kitchen's taking out the regatta.

Robert Spencer, a keen Weta sailor who lives in Dubai and works for Emirates, brought over some awesome prizes: a scale model of an Emirates 777 airplane and a pair of ETNZ binoculars!

For full results of RYC's Multihull Invitational, see www.richmondyc.org.

— weta marine

BAMA Inter-Club Series

Eighteen boats turned out for the Bay Area Multihull Association's Inter-Club Race #6, the final in the series, on September 7. With straight bullets, Steve Wonner's Wyliecat 30 *Uno* killed it in the

THE RACING SHEET



'Wingit' and 'Ma's Rover' at the start of BAMA's final Inter-Club Race.

Spinnaker <140 division, while Robert Fairbank and David Crone's Yankee 30 *Double Play* took the ≥140 class, David Sanner's *Queimada* led the Catalina 34 fleet, Deborah Stern's Cal 39 II *Spindrift* took the Non-Spinny <170 class, Michael Maurier's Alerion Express 28 *Scrimshaw* took the Non-Spinny ≥170 fleet and Mark Eastham's F-31 *Ma's Rover* took home the Multihull trophy.

— *latitude / ladonna*

BAMA INTER-CLUB SERIES FINAL (9/7; 6r,1t)

SPINNAKER <140 — 1) **Uno**, Wyliecat 30, Steve Wonner, 5 points; 2) **Crinan II**, Wyliecat 30, Bill West, 9; 3) **Vita E Bella**, Catalina 42, Jack Verducci, 17. (7 boats)

SPINNAKER ≥140 — 1) **Double Play**, Yankee 30, Robert Fairbank/David Crone, 6 points; 2) **Galatea**, Aphrodite 101, Christopher Viaggi, 14; 3) **Lelo Too**, Tartan 30, Emile Carles, 15. (5 boats)

CATALINA 34 — 1) **Queimada**, David Sanner, 7 points; 2) **Mottley**, Chris Owen, 8; 3) **Crew's Nest**, Ray Irvine, 15. (8 boats)

NON-SPINNAKER <170 — 1) **Spindrift**, Cal 39

II, Deborah Stern, 8 points; 2) **Haute To Go**, Sabre 386, Michael Russell, 10; 3) **Zingara**, Islander 36, Steve & Jocelyn Swanson, 12. (3 boats)

NON-SPINNAKER ≥170 — 1) **Scrimshaw**, Alerion Express 28, Michael Maurier, 7 points; 2) **La Maja**, Islander 30, Kenneth Naylor, 9; 3) **Joanna**, Irwin 30, Martin Jemo, 17. (5 boats)

MULTIHULL — 1) **Ma's Rover**, F-31, Mark Eastham, 9 points; 2) **Three Sigma**, F-27, Christopher Harvey, 10; 3) **Peregrine Falcon**, F-27 Bill Gardner, 11. (8 boats)

Complete results at www.sfbama.org

Race Notes

On September 27, San Diego's **Bill**

Hardesty was inducted into the U.S. Merchant Marine Academy Athletic Hall of Fame in Kings Point, NY. Before earning the 2011 Rolex Yachtsman of the Year award, before winning eight world championships including two as helmsman in the Etchells, two as tactician in the Melges 24, one as tactician in the Farr 40, and three Match Racing

World Championships, Hardesty led the Academy's coed dinghy sailing team to a Singlehanded National Championship in 1995 and Coed Doublehanded National Championship in 1996, won the four-person sloop National Championship in 1998, and was named 1998 College Sailor of the Year.

The Singlehanded Sailing Society moved their season-ending **Vallejo 1-2** from October 12-13 to the following weekend, the 19th-20th. Registration closes on October 16. See www.sfbayss.org.

See *Sightings* on page 70 for our preview of the **Rolex Big Boat Series**.

— *latitude / chris*

More results for your beery pleasure!

ISLAND YC ISLAND NIGHTS FINAL (5r,1t)

SPINNAKER <151 — 1) **Ruby**, Moore 24, Steve McCarthy, 4 points; 2) **Twisted**, Farr 40, Tony Pohl, 9; 3) **Spirit of Freedom**, J/124, Bill Mohr, 15. (7 boats)

168 RATERS — 1) **Phantom**, J/24, John Guliford, 5 points; 2) **Bewitched**, Merit 25, Laraine Salmon, 6; 3) **Faster Faster!**, Merit 25, David Ross, 11. (4 boats)

SPINNAKER >151 — 1) **Wuvulu**, Islander Bahama 30, John New, 7 points 2) **Proverbs 21-21**, Ideal 18, Steve Ritz, 8; 3) **Boogie Woogie**, Ranger 33, John Ratto, 10. (7 boats)

NON-SPINNAKER — 1) **Magic**, Mercury, John Hansen, 4 points; 2) **Loco 2**, Mercury, Paul Mueller, 7; 3) **Dream Catcher**, J/24, Al Spector, 11. (4 boats)

Complete results at www.iyc.org

OAKLAND YC SWEET 16 SERIES FINAL (8r,2t)

NON-SPIN ≤200 — 1) **Some Day**, Islander 36, Roy Samuelson, 8 points; 2) **Jackal**, Ranger 33, Roger Wise, 8; 3) **Willin**, Catalina 30, Mark Tishler, 12. (5 boats)

NON-SPIN >201 — 1) **Loco 2**, Mercury, Paul Mueller, 8 points 2) **Fun**, Santana 22, Chris Nicholas, 12; 3) **Fast Company**, Santana 22, Barbara Miller, 14. (6 boats)

PHRF 148-174 — 1) **Faster Faster!**, Merit 25, David Ross, 11 points; 2) **Bewitched**, Merit 25, Laraine Salmon, 11; 3) **Bandido**, Merit 25, George Gurrola, 12. (7 boats)

PHRF ≤99 — 1) **Dark & Stormy**, 1D35, Jonathan Hunt, 7 points; 2) **Golden Moon**, Express 37, Kame & Sally Richards, 9; 3) **Spirit of Freedom**, J/124, Bill Mohr, 18. (5 boats)

THE BOX SCORES

FAT 30s (PHRF 175-185) — 1) **Nice Turn**, Cal 2-29, Richard M. Johnson, 7 points; 2) **Lelo Too**, Tartan 30, John Ford, 25; 3) **Joanna**, Irwin 30, Martin Jemo, 16. (4 boats)

PHRF >100 — 1) **Cassiopeia**, Islander 36, Kit Wiegman, 8 points; 2) **Wings**, 5.5 Meter, Mike Jackson, 9; 3) **Whirlwind**, Wyliecat 30, Dan Benjamin, 12. (7 boats)

MULTIHULL — 1) **Triple Play**, F-31, Richard Keller, 6 points; 2) **White Knuckles**, Corsair 750 Dash, Gary Helms, 9; 3) **Sunbow3**, Corsair Sprint 750, Ken Johnson, 9. (4 boats)

Complete results at www.oaklandyachtclub.com

ENCINAL YC SUMMER TWILIGHT SERIES FINAL (5r,1t)

DIVISION A — 1) **Good & Plenty**, Soverel 33, Justis Fennell, 6 points; 2) **Twisted**, Farr 40, Tony Pohl, 9; 3) **Red Cloud**, Farr 36, Don Ahrens, 10. (7 boats)

DIVISION C — 1) **Double Trouble**, Moore 24, Kevin Durand, 7 points; 2) **TAZ!!**, Express 27, George Lythcott, 11; 3) **Claire de Lune**, Moore 24, Ted Floyd, 13.5. (12 boats)

DIVISION D — 1) **Bewitched**, Merit 25, Laraine Salmon, 4 points; 2) **My Tahoe Too!**, Capri 25, Steve Douglass, 8; 3) **Osituki**, Cal 28, Rodney Pimentel, 15. (9 boats)

DIVISION E — 1) **Popeye & I**, Cal 9.2, Ruth Summers, 7 points; 2) **Spray**, Coronado 25, Raymond Kyle, 8. (2 boats)

Complete results at www.encinal.org

BAY VIEW BOAT CLUB MONDAY NIGHT MADNESS SERIES CUMULATIVE (5r,1t)

OVERALL — 1) **Cappo Gato**, Nonsuch 30, Sal

Balistreri, 7 points; 2) **Breakout**, Santana 35, Lloyd Richey, 9; 3) **Kai Manu**, Cal 29, John Jaundzems, 15. (8 boats)

Complete results at www.bayviewboatclub.org

MONTEREY PENINSULA YC SUNSET SERIES CUMULATIVE

PHRF A (20r,1t) — 1) **Bustin' Loose**, Sydney 38, Jeffrey Pulford, 28 points; 2) **Encore**, J/105, Dave Potter, 63; 3) **Dude**, Olson 911S, Todd Muck, 106. (8 boats)

PHRF B (27r,1t) — 1) **Morpheus**, Moore 24, Rick Srigley, 104 points; 2) **Kon Tiki**, Cal 29, Austin Book, 121; 3) **U20**, Ultimate 20, Thom Smith, 192. (11 boats)

SHIELDS (25r,1t) — 1) **Rolly**, Pakhtun Shah, 41 points; 2) **Stillwater**, Garth Hobson, 93; 3) **October**, Steve Jackson, 101. (13 boats)

Complete results at www.mpyc.org

SAUSALITO YC SUMMER SUNSET SERIES CUMULATIVE (4r,1t)

PHRF <100 — 1) **Streaker**, J/105, Ron Anderson, 3 points; 2) **Nimbus**, J/105, Neil Gibbs, 6; 3) **Escapade**, Sabre 402, Nick Sands, 8. (5 boats)

PHRF >99 — 1) **Nancy**, Wyliecat 30, Pat Broderick, 4 points; 2) **Grey Ghost**, Hanse 342, Doug Grant, 4; 3) **Ouessant**, Farallon Clipper, Jennifer Hinkel, 12. (4 boats)

PHRF <154 — 1) **Mimicat**, Hinkley 38, Robert Long, 7 points; 2) **French Kiss**, Beneteau 350, Dave Borton, 7; 3) **Jarlen**, J/35, Robert Bloom, 8.5. (6 boats)

PHRF >153 — 1) **Tackful**, Santana 22, Frank Lawler, 3 points; 2) **Maxine**, Yankee 30-1, Stephen Spoja, 6.5; 3) **La Mer**, Newport 30, Randy Grenier, 10. (6 boats)

Complete results at www.sausalitoyachtclub.org

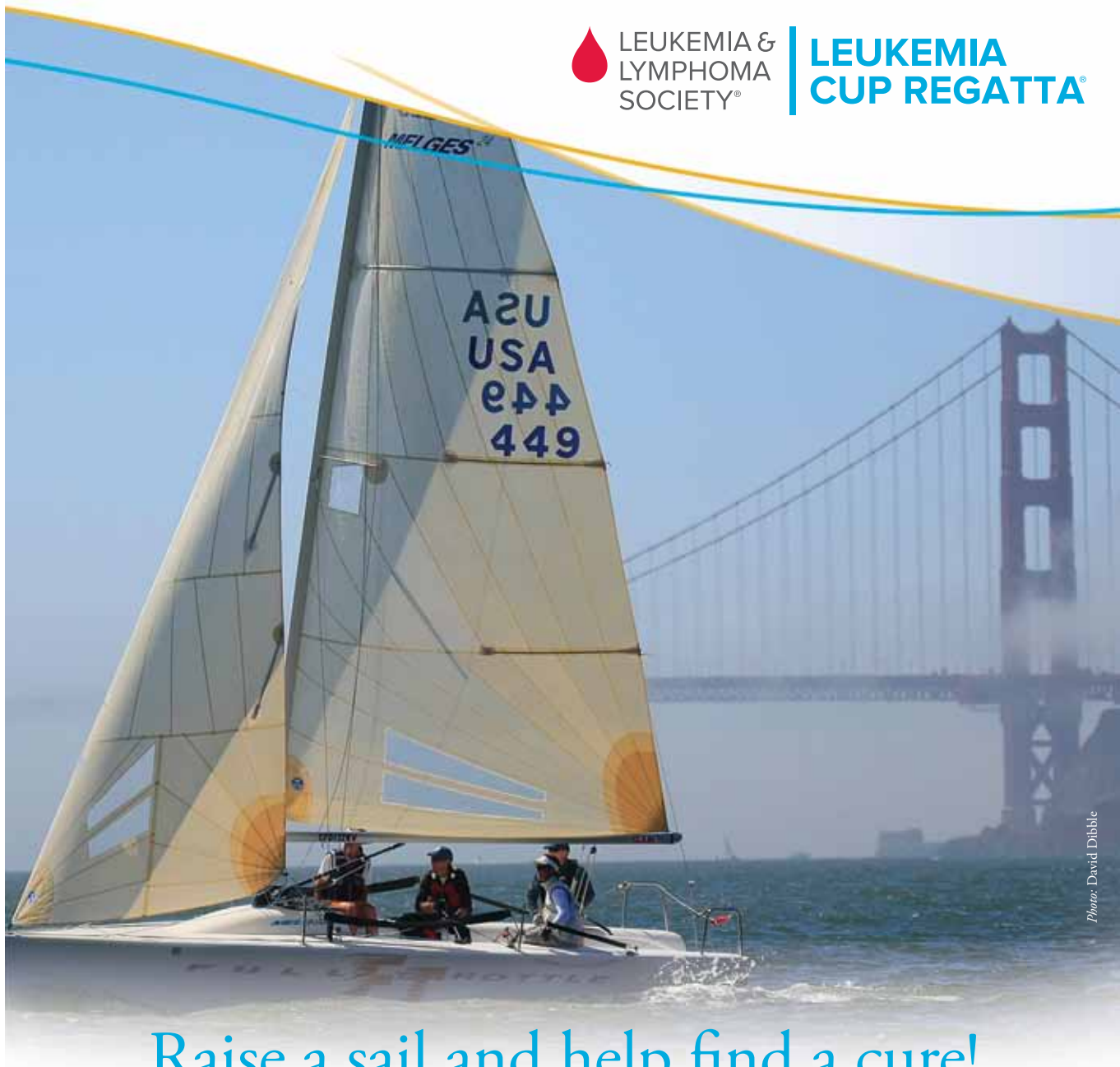

Photo: David Dibble

Raise a sail and help find a cure!

Please join us at the 8th Annual Bay Area Leukemia Cup Regatta.



The San Francisco Yacht Club | Belvedere, CA | October 19-20, 2013

Saturday, Oct. 19

VIP Reception, Auction and Dinner with
Sir Ben Ainslie and National Leukemia Cup
Regatta Chairman Gary Jobson

Sunday, Oct. 20

Races for one design and PHRF divisions
and cruising class activity

www.leukemicup.org/gba

For more information contact Robin Reynolds | 415.625.1132 | robin.reynolds@lls.org

National Sponsors

Ken Gardiner, Gosling's Rum, Jobson Sailing, Inc.,
The Moorings, North Sails, Offshore Sailing School,
Sailing World, Scott Kennedy, West Marine

Spinnaker Sponsors

Belvedere Cove Foundation/Cromar Foundation in honor of
Brit Lacey, Danford Foundation/Ted Hannig, Hot Ticket ~Jeff
Burch, Pacific Union International, Passport Capital, VinAsset

Windward Sponsors

Allied Administrators, Capital Pacific, Corrum Capital Manage-
ment LLC, Enersen Foundation, Ernst & Young, Kilroy Realty,
Knorr Architecture, Merrill Lynch Wealth Management

Local Sponsors

Blue Shield, Broadmark Asset Management, Dailey Financial
Group, Ted & Christie Gazulis, Genentech, Doug & Laurel
Holm, Mark & Susan Israel, Kimpton Hotels & Restaurants,
Martin & Sue Koffel, The "Tad" Lacey Family, Dr. & Mrs. Craig
Lubbock, Stroub Construction, Sutter Health

Inkind Sponsors

Corum, Modern Sailing School, SailorBags, San Francisco
Yacht Club

Media Sponsors

Newstalk 910AM KKSF, Oldies 103.7, Star 101.3, 98.1 KISS

WORLD

We depart from our usual format this month to bring you a special report on the biggest and fastest charter cats in French Polynesia.

The Big Cat Charter Concept: The More the Merrier

Ever since catamarans became widely available in the bareboat charter industry — roughly 20 years ago — their popularity has never stopped soaring, prompting designers to continually refine their products for both comfort and performance.

When we learned about the latest charter cat innovation — luxurious bareboats in the 50- to 60-ft range that can carry 12 passengers — we instantly thought, "Family reunion!" And when we discovered that Dream Yacht Charters had recently added several bareboatable Catana 55s to their Tahiti fleet, we knew those exotic isles were the obvious location to test this big-cat concept.

We floated the idea via email to our sons Zac and Aaron, their uncle Bear, and their godparents Bill and Nancy (with whom we've sailed since college days), and within minutes our inbox alert started pinging in rapid succession: "I'm in!" "Absolutely!" "Yes, yes, yes!" "Name the dates and I'm there." The boys' girlfriends, Holly and April, signed on almost as quickly.

Although we often take neophyte sailors on bareboat trips, knowing this boat would be brand new, and we'd be navigating through reef-strewn (although well-charted) lagoons, it was a comfort knowing I would have a half-dozen experienced sailors on board. A few hours into the trip, though, I realized that my wife Julie and I could have easily run the whole boat ourselves, as all lines are led aft to the cockpit, where a central electric

Oh yeah! Havin' some fun now. While sailing offshore, sightlines were great from either of the twin steering stations.

winch does the heavy lifting (particularly when hoisting the massive, fully battened mainsail).

Equipped with twin steering stations, this sleek 55-footer has excellent sight lines for driving offshore, and although you can't see the opposite bow from the aft helm stations, this performance-oriented boat has much less windage than other large charter cats that feature central steering stations elevated to the level of their hard-top biminis.

For performance upwind, our 55, *Curie*, is rigged with adjustable daggerboards that are easily controlled from the helm, and a self-tending Solent sail that sheets much flatter than the larger genoa (both are rigged on roller furlers). The addition of low-profile solar panels mounted out of sight on the hard-top bimini minimized the time we needed to run the engines or the genset to keep our ample supply of Hinano beer chilled. And a large-capacity, simple-to-use watermaker meant we didn't have to be water Nazis every time one of the ladies wanted to wash her hair.

Having six comfortable double cabins,

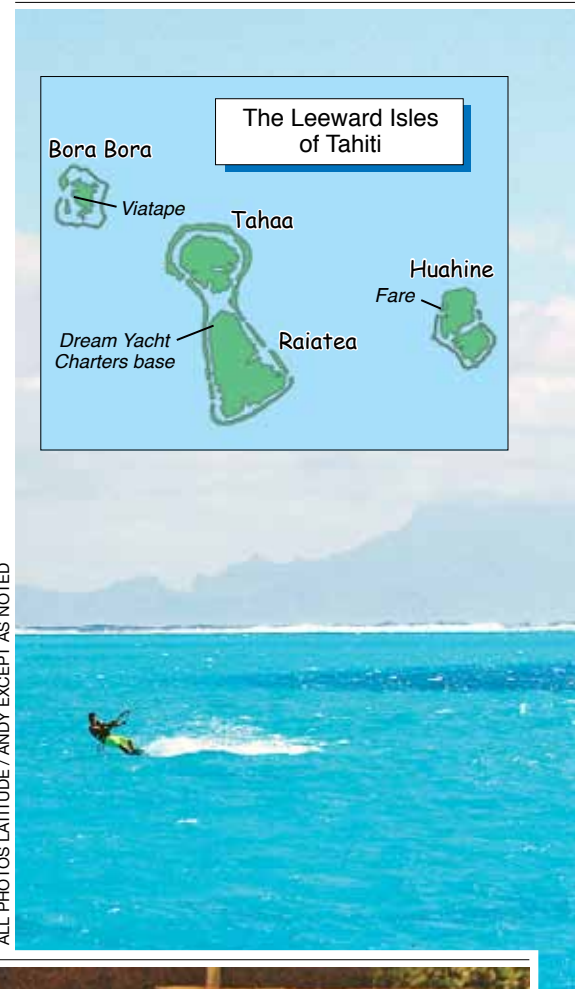

At Bora Bora, the Heiva festival was a memorable cultural treat.

each with its own head and shower, meant that everyone slept well and had plenty of privacy. Yes, each cabin also has individually controlled air conditioning vents, but with Tahiti's near-perfect temperatures — high

70s to mid-80s — we never needed it.

Julie and I have been lucky enough to sail Tahiti's Leeward Islands a half-dozen times before, but for our boys and their girlfriends this was a completely unique experience — like a dream cruise through some sort of tropical fantasyland. They all seemed to be smiling from ear to ear from the moment they got their first look at the brilliant turquoise color of the lagoons.

Unlike the charter trips we took when our boys were younger, this time Dad wasn't picking up the tab for their air



OF CHARTERING



When it came time for personal recreation, Aaron definitely had the most fun. He won't soon forget kiting in the Tahitian lagoons.

fare and expenses. So it was definitely a splurge, but well worth every French Polynesian franc that it cost them.

There's no denying that these islands are known to be expensive. (Air fares are similar to flights to Australia or New Zealand.) But we've found that bareboat pricing and provisioning costs are more or less on par with other tropical destinations. And if you eat what the locals eat — fresh fish, fruits and veggies — and *where* they eat, rather than in swank resorts, these islands are much more affordable than you might imagine. For travelers, the silver lining to Tahiti's pricey reputation is that it sees relatively little tourism — less than 4% of what Hawaii gets annually. So anchorages are never even close to being crowded.

One of the unique characteristics of the Leewards is that each of its four tall volcanic islands is surrounded by a lagoon that's kept tranquil by an encircling reef. With warm trade winds continually washing across the water, the lagoons are ideal for flat-water sailing, as well as watersports like kiteboarding, windsurf-

ing and paddleboarding. And, of course, deep sleeping at anchor.

The last thing you want to do in a place as idyllic as Tahiti's Leewards is rush from place to place, so for a week's charter we usually recommend visiting the central islands, Tahaa and Raiatea, and *either* Huahine or Bora Bora, but not both.

The first-timers in our group were determined to see it all, however, so we agreed to leave our schedule loose and play it by ear. Who knows, we thought, maybe the speed of this 55-footer will allow us to see more in a week than we'd done on past cruises here.

After sorting out our provisions, we did a thorough checkout with Dream Yachts' base manager, jovial Jérôme Touzé, who's sailed here for decades. We then set sail for a

favorite snorkeling spot at an uninhabited *motu* (islet) perched just inside Passe Toahotu, a break in the fringing reef on the east side of Tahaa. When the crew returned to the boat from snorkeling just before twilight, they were giddy as grade-schoolers after a big night of trick-or-treating. Only here the excitement was over the abundance of colorful tropical fish, rather than Halloween candy. After a splendid dinner of fresh-caught tuna, we spent a tranquil night anchored over a vast sandy plain that reflected the moonlight above.

The least developed of the principal Leeward Islands is Huahine, which is our favorite. Getting underway early, we put the boards down, trimmed for upwind sailing and blasted across the 22-mile open-water channel in record time. Despite her finely finished interior and large tank capacity, *Curie* hit 9 knots consistently upwind.

There's not much to 'downtown' Fare, Huahine's largest village, except a few surf shops, a grocery store, two banks, a pharmacy and a shack that sells chilled coconut water in the shell. But the adults are friendly, the playful kids are curious, and virtually every home is surrounded by lush gardens that yield bananas, papayas, mangos and breadfruit — the sort of place you could live a blissful life completely devoid of the workaday world that most vacationers try to escape from.

After a bit of shopping and a swim, we motorsailed south through the western lagoon to broad Avena Bay. Strong winds were beginning to pipe up, inspiring Aaron to dig out his kiteboarding gear and give us a show.

The next day a squally morning forced us into 'island mode'. That is, chilling

It's a great comfort having plenty of reliable sailors aboard — unless they all want to play captain at the same time.



WORLD

out and enjoying the lack of any pressing engagements other than a promise to go snorkeling out on the nearby reef, which gazillions of juvenile fish call home. Later, the kids went ashore to check out a small waterside resort, test their newly-learned Tahitian — *ia orana* (hello), *maeva* (welcome), *maururu* (thank you) — and procure some exotic cocktails.

The next day was the most memorable sailing day we've ever had in these islands. Up at first light, we motorsailed through the golden hues of early morn-

ing back to Fare, rolled out the genoa and charged back to Tahaa in record time, hitting 12 knots or higher along the way. I'd been telling the kids how the wind usually bends along the rounded shape of the island, so that when you sail around it counterclockwise you rarely have to adjust your sail trim. That proved true yet again, and what fun — beam-reaching at hullspeed over flat water.

It was the Fourth of July, and our plan was to anchor for the night near Motu Tautau, so we could explore the must-

see Coral River there that lies adjacent to a luxurious resort. But we'd made such good time that it was barely noon, so the crew's consensus was to push on to Bora Bora, thus experiencing a *trois iles* day! The strong *maramu* winds had roughed up the seas offshore, which sent 8-foot rollers into the fringing reefs. But as always Tahaa's western exit, Passe Papai, was still calm, if a bit roly. The big cat plowed through the swells almost effortlessly, and we were soon reeling in the miles to the Leewards' most iconic



AARON TURPIN



JULIE TURPIN



ALL PHOTOS LATITUDE / ANDY EXCEPT AS NOTED

OF CHARTERING

silhouette, the sharply sculpted Mount Otemanu in the center of Bora Bora.

A couple of hours later we were skirting the long, foreboding reefs that protect the Bora Bora lagoon, before reaching its only entrance, Passe Teavanui, which lies midway up this famous atoll's western shoreline.

First known to Americans as the

site of a WWII airstrip, Bora Bora today receives the vast majority of French Polynesia's tourists, many of whom are honeymooners who book over-water bungalows at world-class resorts. Some are truly spectacular, but they can cost \$1,500 a night or higher. We like to point out that you get the same view from a bareboat, but you can change the scen-

ery whenever you like.

After overnighting on a mooring ball in front of Bloody Mary's restaurant, we dinghied to a favorite reef nearby for a morning snorkel, then motorsailed around to the shallow eastern side of the lagoon. Deep-keeled monohulls dare not travel in these shallows, but for cats — even 55-ft cats — it's *pas de problème*. Near the southernmost end we shared a vast 10-foot-deep anchorage with only two other boats. The turquoise color of the scene was hypnotic as Aaron did kiteboarding cartwheels while the rest of

Top row, left to right: Fresh baguettes were plentiful; the surf break outside Fare; surveying Mt. Otemanu from the Bora Bora lagoon; Julie hails a passing cruiser. Center: Zac and Holly take a plunge; sleepy downtown Fare; birthday boy makes a friend; canoeing, the national pastime. Bottom: Our sweet yacht and a classic church; Bear chills on the foredeck; 'Curie' between the motus.



WORLD OF CHARTERING

us snorkeled, shadowing several elusive sting rays.

The kids were anxious to find a primo snorkeling spot, so we moved the boat to a shallow ledge between two small *motus* (Piti uu Uta and Piti uu Tai), beyond which was a huge reef system. That instinct paid off bigtime, as the reef was teeming with life and we identified almost every species on our fishfinder chart.

The next day was Aaron's birthday. To celebrate we'd planned to moor near Vaitape, the island's only town, where the annual Heiva cultural festivities were going on. The breeze was up for our 8-mile trip around to the west side, so while we sailed, Aaron zigged and zagged around us on his kiteboard, doing occasional flips and other flashy aerobatics. Zac decided it was time for his first lesson, which he survived — just barely — after accidentally body-dragging across a nasty patch of shallow reef.

We found a mooring at the new Mai Kai Marina and YC, within shouting distance of several cruising couples we'd met in Mexico. (Small world.) On the short walk to town the air was charged



JULIE TURPIN

Showering with a friend is always fun — especially on the swim step of a luxury catamaran moored in the Bora Bora lagoon.

with excitement as the sound of hardwood drums grew ever louder.

The dance competition was fantastic, with the long-haired ladies doing those rapid-fire hip gyrations that only Poly-

nesian anatomy allows, while their men stomped and strutted in the fashion of their forefathers. The locals could not have been more welcoming to us and the small cadre of cruisers who attended. The birthday boy even got to try on the elaborate headress of one of the dancers.

The trip back to Tahaa was a long beat in brisk winds, but *Curie* handled it well, getting us back to the Passe in time to retrace our route up to the Coral River, where we played in the 2- to 3-foot water for hours. The highlight was when a moray eel chased Bear through the coral heads in retaliation for getting too close with his GoPro.

We spent our final night at Tahaa's Baie Apu, only a few miles across the lagoon from the Dream Yachts charter base at Raiatea.

From beginning to end, it had been a wonderful cruise aboard an outstanding charter yacht. We've done many family bareboat charters during the past two decades, but this one was certainly a standout. And it will certainly be a tough act to follow.

— andy

British Virgin Islands Belize The Grenadines

TMM
Yacht Charters

We're the Real Deal.
Real People. Surreal Places.

"Let us show you around
our backyard."

Barney & Lin Crook
Owners of TMM for 32 years

www.sailtmm.com
1-800-633-0155

Are "Californians Dreaming?"

Stop dreaming – go sailing.

**CALL TO RESERVE AT OUR
BEST IN THE BVI PRICES!**

**Conch
Charters**

www.conchcharters.com
(800) 521-8939

BoatSmith

561.632.2628

www.BoatSmithFL.com

We Build Your Dreams



#1 Selling LED Brand



The Navy specifies the use of Dr. LED's lights. Shouldn't you?



www.DoctorLED.com



BVI YACHT CHARTERS

Call: +1 888 615 4006
Or: +1 284 494 4289

BVI Yacht Charters is the first port of call for all yacht charters in the BVI and St Martin. Whether you are looking for a Catamaran or a Monohull, a week or just a few days, our professional team is on hand to make it work, your way.

BVI YACHT CHARTERS

** 10% off all new bookings when you mention this ad.

www.bviyc.com
charters@bviyc.com

weatherguy.com

Worldwide Marine Forecasts Cruising, Racing & Commercial

Packages Starting at \$65.00 USD

(866) 882-WXGY (9949) toll free
(808) 291-WXGY (Mobile)
(808) 254-2525 (Office)
(808) 443-0889 (Fax)



970 N Kalaheo Ave
Suite C-104
Kailua, Hawaii 96734
info@weatherguy.com

www.weatherguy.com

CHANGES

With reports this month from **C'est La Vie** being seized and allowed to go on a reef at Chuuk Lagoon; from **Kiapa** on the many delights of Bora Bora; from **Esprit** on cruising Spain from Menorca to Cartagena; from **Harmony** on the state of affairs at Tenacatita Bay, Mexico; from **R Sea Kat** on taking the long way from the East Coast to Southern California; from **Knee Deep** on a two-year family cruise; from **Larrakin** on fun in French Polynesia; and **Cruise Notes**.

C'est La Vie — Amel Mango 52 Bob Bohn and Crew Hilda Boat Seized, Destroyed at Chuuk (Anacortes, Washington)

Two days after clearing into Chuuk (Truk) Lagoon in the Federated States of Micronesia, my boat was boarded by the Chuuk State Police. They hit me in the face, dragged me down the deck, and threw me into their boat. They took my boat papers and passport, arrested me and my crew Hilda from the Solomon Islands, and put us in jail without any charges.

After 24 hours, I demanded to see a judge. Two hours later the judge ordered us released and asked the police why they weren't helping us. I flew Hilda out of the country immediately.

Three days after being arrested, I returned to the scene to find that despite the fact that my boat was supposedly being looked after, the anchor chain had slipped and she was hard on a reef. Furthermore, everything — solar panels, dinghy, outboard, generator, kayak and fuel cans — had been taken from on deck. Five police, who were removing all the valuables from below, prevented me from getting any closer to my boat than 100 feet.

In the course of a month, I was never allowed to board my boat again, despite **'C'est La Vie', a lovely Amel Mango 52 that had done the Puddle Jump and Ha-Ha, hung up on a reef at Chuuk after being seized.**

court orders saying I could. The last time I tried to get on my boat, she was being guarded by a policeman — in my kayak! Worst of all, by that time she was on the reef. The last time I saw her, she was banging on the reef so hard that the radar was knocked off the mizzen.

After nearly a month, the public defender representing me advised me to heed the death threats I'd been getting and to leave the island immediately. By that time I'd burned through my cruising kitty on expenses and fighting to get my boat back. The police arrested me one last time before I left the island, just to show that they could.

From a short time after we were first arrested, I contacted and kept in contact with the U.S. Coast Guard in Guam, the U.S. embassy in Pohnpei, and a law firm. Everyone expressed an interest in my situation, but there was nothing anybody could really do.

The Director of Tourism for Chuuk tried to persuade me not to tell my story, but I feel it's important that cruisers know about the dangers of going to Chuuk. I was told by others on Chuuk, and later by officials on Guam, that it's not uncommon for boats to be seized in Chuuk, and that the level of crime is very high.

Five attorneys have told me I could easily win my case in court. Unfortunately, it would be very expensive and the Federated States of Micronesia doesn't have the money to pay any award/settlement.

My main message to cruisers is to avoid Chuuk Lagoon! If you insist on sailing there, go as part of a group of boats, not alone as we did. We were seen as rich yachties and thus an easy target for plunder.

This incident was in contrast to the wonderful time I had been having in the South Pacific after the Puddle Jump. I did Tahiti, the Cooks, Suvarrow and the Samoas, and hauled the boat in Fiji for the hurricane season. People were wonderful. I then did Vanuatu and the Solomons. Hilda and I then headed for 1,700-mile-distant Guam. After 1,200 miles, we made the unfortunate decision to stop

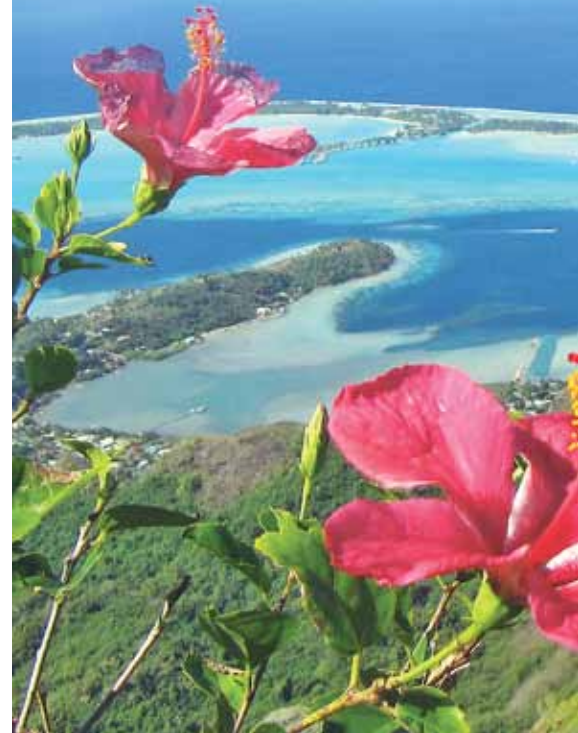

for provisions at Chuuk, which used to be the South Pacific base for the Japanese Empire during World War II.

I only had liability insurance, so I lost everything. But I have a good pension from doing bomb disposal in the Navy, so I expect to be cruising again in another couple of years.

— bob 09/08/2013

Kiapa — M&M 52 Cat Lionel and Irene Bass Bora Bora (Perth, Australia)

When most cruisers think about cruising destinations, they want to tick off the following boxes: warm air and warm water in which to play; spectacular scenery; plenty of sea life to observe while snorkeling; the opportunity to engage in rigorous physical activities, allowing one to 'earn' their sunset cocktail; and with this, the time to relax with good friends

C'EST LA VIE



Bob Bohn

BOB BOHN



IN LATITUDES



SPREAD, KIAPA, INSET, LATITUDE

Bora Bora has more than just a great silhouette. The island and the lagoon look great from near the summit of 2,385-ft Mt. Otemanu, too.

and good books.

During the three weeks Lionel and I were lucky enough to spend at Bora Bora, we were able to tick off all of the above boxes — and more.

Considered by many to be the most beautiful island in the world, Bora Bora is a mere 11-square-mile remnant of an extinct volcano, with two prominent peaks, and is surrounded by an extensive shallow lagoon and barrier reefs. Mt. Otemanu, the highest peak, is 2,385 feet, making it not quite as tall as Marin's Mt. Tam. Located 143 miles northwest of Tahiti — and 4,200 miles from San Francisco — Bora Bora has a permanent population of just under 9,000.

Capt. James Cook was the first European to come ashore in 1770. Not many followed in his path until 7,000

American soldiers set up an uncontested base during World War II. Following the introduction of jet aircraft, Bora Bora became an exclusive destination for upscale tourists, many of whom were attracted by the signature hotel rooms on stilts over the lagoon. Harvesting tourist dollars has replaced harvesting copra as the island's economic engine.

While most visitors arrive by plane, the most stunning views are afforded those who arrive by boat. As we approached the turquoise waters of the lagoon from which the dramatic peaks soar up, Lionel and I thought it looked like a dream destination. We would not be disappointed.

On the day we arrived, Izzy of *Cariba* and I got into the dinghy and took off in search of a small

beach where the crews of seven boats — *Osprey*, *Cariba*, *Nyon*, *Compass Rose*, *Monkey Fist*, *Red Sky Night* and *Kiapa* — could have a potluck that night. Fortunately, Izzy speaks French. So when we saw a man sitting at a picnic table in a garden that went all the way down to the beach, we pulled up and asked if he knew of a public beach where we could have our potluck.

"No," said the man who identified himself as Patrick, "because all the nearby beaches are 'owned' by either the hotels or by the homes that front them."

So Izzy boldly asked if we might hold our potluck on Patrick's lawn, and if we could, would he join us. Fortune favors the bold, for Patrick said that he would be delighted to host us. Furthermore, he said he would like to contribute to the potluck and entertainment.

It turned out to be a great potluck, as the crews of all the boats knew each other from before and were eager to catch up. As for our host Patrick, he prepared freshly caught fish in a delicious coconut marinade, demonstrated how to shuck and grate a coconut and how to cook, peel and eat breadfruit, and even enthusiastically sang a rain dance for us. We all had *such* a fantastic evening.

The next day we returned for our morning yoga stretches, and Patrick joined in. When the session was over, he offered to take us on a hike that no tourists had ever been on. Naturally we all wanted to go.

A few days later, five of the boats in our group upped anchor and moved to *Irene*, at the far right in blue, had many above-water cruising friends at Bora Bora, and quite a few below-water ones, too.



Patrick of Bora Bora.



KIAPA

KIAPA

CHANGES

the eastern side of the lagoon in order to be closer to where we'd been told we could snorkel with big manta rays. Apparently the rays visit this 'cleaning

station' each morning. It's sort of like a car wash for rays; as they pull in, smaller fish, usually cleaner wrasse, feed on the debris on the skin and in the gills of the rays. It was magical to watch, and we were lucky enough to enjoy three 20-minute sessions. Nature is marvelous.

Most people know Bora Bora from its famous silhouette, among the most recognizable in the world. One cloudless day Izzy and Gabriel from *Cariba*, Patrick from *Living*, and I decided to swap our flip-flops for hiking boots and tackle one of Bora Bora's two peaks to get a different view.

In retrospect, I have to wonder what I'd been thinking. The three of them are Canadians, and they all have oodles of rock-climbing experience. This was important, because during a number of sections of the hike we had to use ropes to get up and down sheer rock faces. Those folks were like rock rabbits while I was slower than a sloth. But my reward — a fabulous view from the summit — was easily worth the effort. We'd chosen a clear day specifically so the colors of the

Lionel and Patrick revel in the great kiteboarding conditions — strong wind, flat and warm water — of the lagoon at Bora Bora.



surrounding waters would be dreamlike.

Our next anchorage was at the south eastern extremity of the lagoon, chosen specifically for its quick access to the nicest kiteboarding beach we'd seen in French Polynesia. I say 'nicest', because it was actually wide enough to make the launching of our kites not too tricky, and there were no coral bommies — aka 'potato heads' — to avoid in front as we headed out. And the trade winds blew 20 – 25 knots as predicted. Heaven!

After the three weeks Lionel and I spent at Bora Bora, we realized how blessed we were to be able to experience its pleasures for an extended period of time, and not just for a jet-lagged week.

— irene 08/29/2013

Esprit — Peterson 46 Chay, Katie and Jaime McWilliam Menorca to Cartagena, Spain (Henderson, Nevada)

One of the more unusual highlights of this, our 10th season of cruising, has been adjusting to the topless and even nude sailors — both men and women — here in the Med. Some are attractive, some not so attractive. They not only sunbathe *au naturel*, they sail, dinghy and anchor that way, too. There was even a topless woman SUP-ing through an anchorage without a care in the world. Europeans have a more liberal view of nudity.

The Europeans, however, are very family-oriented. Most of the people we've seen on holiday are vacationing as a family — including teenagers and young adults traveling with their parents. That's something we don't see much in the States anymore.

The European Union countries require Certificates of Competence for boaters. A number of Europeans told us that most of the test is related to knowing what different lights and light combinations mean. It's been quite apparent to us that one can obtain a certificate without demonstrating any competence in anchoring.

Most, but not all, European mariners use 3 to 1 scope — at the most — when anchoring. We've even seen some boats 'anchor' 1 to 1. When the wind comes up,

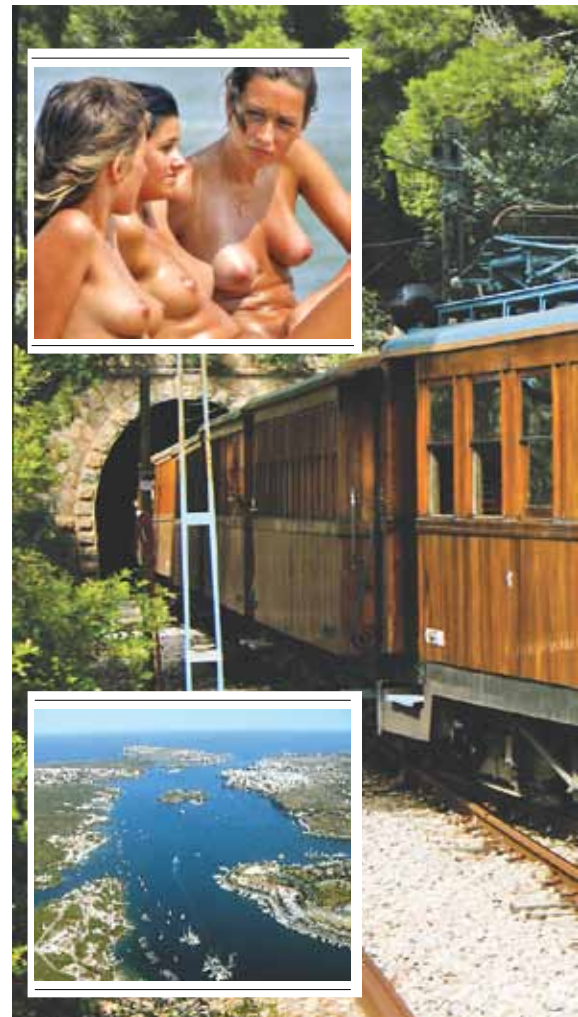

they seem puzzled that their boats are dragging.

We have previously mentioned that very few American boats seem to be coming to the Med. The only ones we have seen so far have crossed the Atlantic and/or are from the East Coast. This is apparently due to lingering fears about the Somali pirate situation in the Indian Ocean. This year we met an Aussie who shipped his boat to Gibraltar in order to get to the Med without having to worry about pirates. We also met a Kiwi who avoided the pirates by sailing eastward across the Pacific, through the Panama Canal, and across the Atlantic! Cruising dynamics have certainly changed.

Since we last wrote, we anchored at the entrance to Mahon, which is on the east coast of Menorca and is the island's biggest city. The bay is beautiful, with many potential places to anchor. Unfortunately, officials have made it illegal to anchor almost everywhere, so you must move into a marina. After a night, we moved on to Cala Trebalúger on the south side of the island, where



IN LATITUDES



Spread; The ancient but beautifully restored train that takes passengers from downtown Palma up into the mountains, through tunnels, and down to the town of Soller. From there, you take another ancient train to Porto Soller. Lower left; The great natural port of Mahon. Top left; Topless is normal.

we enjoyed three days of crystal-clear water, a white sand beach, swimming and snorkeling.

Our next passage, down the east coast of Mallorca, the biggest of Spain's Balearic Islands, turned out to be a longer one than we'd planned. The wind and swell were out of the east, making most anchorages untenable, so we had to continue on around Punta Salinas on the southeast corner of the island. We anchored there behind Isla Moltana.

Our watermaker had stopped due to a failed membrane, so we ordered one to be shipped to us at Cartagena, Spain, our next stop. Since we needed to fill our water tanks and wash down an extremely salty/dirty *Esprit*, our next stop was Palma de Mallorca's Marina Club de Mar, a well-run, privately-owned marina with a helpful and amiable staff. Chay was able to apply more coats of varnish there. He also found a few parts we needed at the various chandleries,

but we were generally disappointed in the chandleries. Although their shelves were full, their stock didn't include the stuff we were looking for.

We toured the city of Palma one day, including the very large cathedral that was built on the site of a 14th-century mosque. Many of the buildings are of Arab origins. The next day we took a beautifully restored and maintained electric train — built in 1812 — on a windy trip up into the mountain and through tunnels, then back down again to the town of Soller. From that little town of cute shops, we hopped onto another little train down to Porto de Soller, where we had lunch before taking the train back to Palma. It was 100 degrees and muggy, but a fun trip.

After Palma we motor sailed to Cala Blanca, where we waited for another gale and some stormy

weather to pass before moving to the southern Balearic party island of Ibiza. We experienced heavy northwest swells from the gale blowing in the 150-mile-distant Gulf of Lyon, so once again the anchorages along the west coast of Ibiza were untenable.

We ended up going around to Cala de Port Roig, where we anchored among all types and sizes of boats. Some were free-anchored, some were on single moorings, and some were on bow and stern moorings. Very disorganized.



Cartagena is classic.

We then set sail for 130-mile-distant Cartagena, Spain. It's hard to believe, but we didn't catch our first fish in the Med until that leg. But it was a beautiful 40-lb albacore tuna. He swam deep, but Chay reeled him in. We must have been in a school of tuna because his friends stuck with us for quite awhile — something that we had never seen happen before. That tuna was the best-tasting fish we've had in our 10 years of cruising!

After a mostly rolly trip to Cartagena, we are now side-tied in a marina. The staff is friendly and the facilities are acceptable. We've taken a few strolls through town, which is pleasant and mellow. There are many forts, Roman ruins and castles to explore before we leave. We will now use our Eurail passes to travel inland.

— chay 08/20/2013

Harmony — Islander Freeport 40 Robert and Virginia Gleser Mayor and First Lady of Tenacatita (Alameda)

We recently had brunch with several cruising buddies, and enjoyed reconnecting with Kurt and Katie Braun of the

The popular cruiser anchorage is behind Punta Las Iguanas. Playa Tenacatita is open again but has no palapas. Manzanilla has all the crocs.



CHANGES

Alameda-based Deerfoot 74 *Interlude*, who just completed their 12-year circumnavigation. We first met them at Tenacatita Bay, Mexico, in 2002 and followed



Robert and Virginia, 'Mayor' and 'First Lady' of Tenacatita.

their stories as they made their way around the globe. They are planning to return to Mexico for more cruising fun, and asked if the rumors of Tenacatita Bay being closed were true. So here's the scoop from Robert, the high season 'Mayor' of Tenacatita Bay:

There are two anchorages at Tenacatita Bay, the outside beach anchorage and the more protected inside bay anchorage. The inside bay, which is sheltered from the Pacific swells, is the place where most of the cruisers like to anchor. It's in front of a beautiful, long white sand beach, where there is one *palapa* that sells typical inexpensive Mexican seafood. There is also the Blue Bay Hotel, which features an hour-long serenade for us each evening. Baitfish and their predators circle the boats, and dolphins often cruise through. Egrets, pelicans, boobies, and gulls are some of the wide variety of snowbirds that visit during the winter season. There is no problem with the inside bay anchorage.

There had been a legal squabble over on the outside beach between a very rich man and a lot of poor people, and after a judicial ruling two years ago, the rich man was declared the winner. Many houses, *palapas* and restaurants were quickly bulldozed, and the public was not allowed to return to the beach. Things have loosened up a bit over the

The famous 'jungle ride' from Playa Bocas de Iguanas to Playa Tenacatita. Alas, it's overgrown in places, particularly at the entrance.

last two years, so people can now drive in to the beach and cruisers can land on the beach for a walk. But there aren't any restaurants, shops or amenities.

There is still a 'jungle run' through the mangroves from the inside bay to the lagoon bordering the outside beach, where for many years cruisers had taken their dinghies for provisioning and lunch at a favorite beachfront *palapa*. Most of the jungle run is still there, but overhanging mangroves have been allowed to grow back and cover the tunnel-like entrance to the lagoon. Furthermore, visitors are no longer welcome to dock nearby to gain access to the outer bay beach. However, cruisers can still anchor out, snorkel the 'aquarium', and come ashore to walk the beach. Many of the good restaurants that were formerly at the outer bay relocated to La Manzanilla, a small town 2½ miles across the bay. That's where cruisers now go to enjoy fine dining and provisioning — and see all the crocs.

This past season's news was that things are still being hashed out in court, and the fight may not be over.

This will be our 14th year of cruising the Pacific Coast of North and South America. Instead of our usual early October trip to Mexico, we will forego that great meandering cruise down the inside of Baja in the perfect weather month of October/early November in order to attend the wedding of our exchange-student daughter. She is getting married in Seville, Spain. The opportunity to see her again and meet her family, not to mention spending time in Europe, was irresistible. For our return trip, we are making a trans-Atlantic crossing on a super cheap Norwegian cruise ship that is repositioning from the Med to the Caribbean.

Sometime in November we will make the pilgrimage down to Mexico to prepare *Harmony* for launching from her summer home on the hard in San Carlos, Sonora. Instead of crossing to Baja, we'll be making a more direct passage to the warm southlands: Topolobampo, Mazatlan, Puerto Vallarta, then Tenacatita — where the kids and grandchildren are planning to come for the winter holidays.

As usual, we are looking forward to spending another season on the Gold Coast, and want to welcome all the Mexican cruisers — and particularly the newcomers — to



spend part of the winter months playing bocce ball on the beach and enjoying the warm clear waters of Tenacatita. The mayor's Friday night dinghy raft-ups that have been an institution for over three decades are always a highlight. We tie our dinghies together in a large circle around the mayor's anchor, and share hors d'oeuvres, stories and lots of laughter.

This report would not be complete without my pushing Virginia's book *Harmony on the High Seas, When Your Mate Becomes Your Matey*. Her insightful book explores the leap of faith that you take when you cast off the docklines, and shares both a tangible and mystical view of the sailing experience.

— robert 08/15/2013

**R Sea Kat — Manta 40
Captains Deana and Mike Ruel
Bluewater Cruising on a Cat
(Dover, Delaware / Lake Sherwood)**
We don't normally publish photos as

JUNGLE JIM





summary, our experience has confirmed our expectation that this well-built catamaran will take us anywhere between the equator and the Arctic in safety and comfort."

— *latitude/rs*
09/12/2013

Knee Deep — Catalina 38

The Doolittle Family The Two-Year Cruise (Sacramento)

Two years ago, the Doolittle family — Ben, Molly, and sons Mickey, then 7, and JP then 9, paid \$25,000 for *Knee Deep*, a San Diego-based 1983 Catalina 38 on which to go cruising. Although older, the boat was in very good condition and came with almost all the cruising gear — chartplotter at the helm, log, radar, windlass, two anchors, roller furling, spinnaker setup, refrigeration and freezer, sails in decent condition and a nearly new 50-hp diesel. The family could have bought the boat's 11-

Spread; A lovely photo of 'R Sea Kat' wing-on-wing with a camber spar headsail. Insets; Captains Deana and Mike.

large as the one above, but it's so evocative of cruising that we couldn't resist. Just beautiful.

The boat in the photo is Mike and Deana Ruel's Manta 42. They've cruised her from the East Coast to Southern California the 'long way', meaning by way of the Caribbean, Panama Canal, Galapagos and Alaska. They are currently looking to have a leak in a saildrive and some other repairs taken care of in preparation for the start of the Pacific Puddle Jump next March, and they're also collecting data for a book about enjoying California's Channel Islands.

Michael is one of the cinematographers for the "coming soon" movie about Laura Dekker of *Guppy*, the youngest person to circumnavigate. *R Sea Kat* and Deana and Michael are also featured in the film.

Given the couple's considerable off-

shore experience with a relatively small cat, we asked them for their evaluation of a Manta as an ocean-cruising boat.

"Having lived aboard our Manta for over three years now as we cruised the Atlantic, Bahamas, Caribbean, Panama, Galapagos and Pacific waters to Alaska, we've have found her to be an exceptional bluewater cruising platform. She meets nearly all of the offshore liveaboard requirements and is well-appointed. There is excellent headroom and the fridge and freezer have generous space. The cockpit is roomy and well protected from heavy seas, and the decks are wide and clear for easy movement fore and aft in rough conditions. We have experienced 35-40-knot winds and 20-foot seas for several days in succession with no concern for our safety or that of our cat. The Manta's upwind performance is acceptable for a catamaran, and the beam or downwind performance is excellent. In

ft inflatable and outboard for another \$1,000, but opted for a smaller inflatable and outboard for \$600 from a second-hand shop. The boat did not come with a liferaft or AIS.

"The gear was all new enough so that its service life lasted until we got to Annapolis this summer, two years later, where we sold the boat," says Ben. "By

The Doolittles aboard their Catalina 38 'Knee Deep'. They got a lot of boat — and a lot of cruising gear — for \$25,000.



CHANGES

that time some of the gear — such as the inflatable — was getting pretty tired."

The family started their cruise with the 2011 Ha-Ha, and had what Ben describes as an "awesome" time. "But I don't think we're going to fully appreciate it until more time goes by."



Heeling games.

Speaking of time, Ben figures it was just the right time for the family to go. "The boys were old enough to appreciate the trip, but not old enough to be able to do anything about it — if you know what I mean."

As is the case with many cruises, it was the man's dream. Ben had been cruising before, and was absolutely certain about wanting to do it again with children. Molly was game for a long time, but "got burned out" after 18 months. The solution was for Molly and the kids to fly to the States, and Ben and a crew sailed the boat to Annapolis.

"I have to say that the Catalina 38 was a fine sailing boat," says Ben. "We buddyboated with a lot of Tayanas, Hans Christians and Valiants going down the coast of Central America, and many times they felt they had to motor while we were able to sail. Compared to the other boats, the Catalina was fairly light displacement, so I loved throwing up the chute in light air. But the guy who sailed from Panama to Annapolis with me was used to cruising in heavier displacement boats, and he was shocked at how much

It may not seem like it at the time, but thanks to photos such as this, the pleasures of the family cruise will last a lifetime.



KNEE DEEP

Knee Deep bounced around. So maybe a Catalina 38 isn't the most comfortable offshore cruising boat. As for myself, if we could afford it, our family would be on a cat in a minute."

After Ben and his crew got to Annapolis, there was no problem selling the boat quickly. "She went in less than one month for \$5,000 less than we had paid for her. As we'd lived on the boat for two years, during which time we cruised from California to Panama to Annapolis, we thought that was a pretty good deal."

— *latitude* 09/02/2013

Larrakin — Catalina 42 Peter and Gabriela Verdon Adventures In French Polynesia (Australia)

July began with the wind still blowing plenty hard in the Tuamotus. When we weren't going to get blown away, we enjoyed daily excursions all over the motu, and the guys surfed as much as possible. It was nice to have friends around, and we managed a couple of dance sessions on each other's boats — although *Larrakin's* mosh pit rules.

Our friend Chris lent us his truck, so we had a hoot driving all over without ever getting out of second gear. The road is a big loop that encompasses the airport runway. At the center of the island there is a two-story concrete bunker. It's supposed to shelter the island's population of 400 if it were to be threatened by a tropical cyclone. Chris also offered us a job helping run *Ninamu* for the month of August while he would be off in Papeete serving as surf contest director at Teahupoo. We decided against it as we're already running a little late in our South Pacific wanderings.

We were soon watching the GRIB files with interest as a huge front was nearing. We had plenty of wind and rain for a couple of days. Although it was uncomfortable, we were safe, but others in the Tuamotus were not. On of the boats at Fakarava ended up on the reef, and at last word was still there. Many other boats smashed into bommies, which are the coral heads in the anchorages. Our friends on *Sea Nymph* tried to cross to Papeete, but turned back to the atolls. It was dangerous, but they felt it was their best option.

We took *Larrikin* into the small unmanned marina after the blow and tied up for a couple of days. What a treat, as it was the



first time we'd been tied to a dock since Mexico. Even without facilities it was a joy to be able to walk onto and off the boat. The marina's lights enticed huge manta rays to appear most nights. Glorious beasts they are!

Even though it was still squalling, we decided enough was enough, and made a very fast and uncomfortable 100-mile passage to Papeete. We only had a little sail up, but we averaged 7.5 knots. We got more salt on the boat as a result of that 100-mile trip than we did on our 3,000-mile crossing from Mexico.

All in all, our Tuamotus experience was nothing like the old days, as it blew for all but a couple of days. In previous trips we had glassy seas for weeks on end. As in other parts of the world, weather patterns seem to be changing.

We happily took a mooring at the Tahiti YC. We were reminded that hot showers and a laundry are among life's little joys. Leina, the owner of the cafe, became an instant mate. Her son is the F18 catamaran world champion, and the previous weekend had won the Mixed

IN LATITUDES



TAHITI TOURISM



Clockwise from above; Beautiful Moorea; the old market in Papeete; Verdo on surf patrol; the anchorage at Marina Taina; Gabby and the strongment.

Worlds in Nacra 17s. A local sailing hero, he's now sailing on Dona Bertarelli's MOD70 *Spindrifft*.

We were the only cruisers at the Tahiti YC, as all the moorings are private. The French locals were as odd as the French can be. For example, the couple to one side of us were nude all day and night, and the old boy on our other side was in his same brown undies for the duration.

The yacht club is about four miles out of town proper, and you can hitch around. Buses appear sporadically at best, and only stop when the driver feels like it. They don't run at all on Sunday, the biggest market day, which is why the old hitch was so important.

The massive Carrefour store up the road has the best pâté collections I've seen since France, and the only shock was the prices. After Mexico's low prices on everything, French Polynesian prices were a shock to the system. They even

made Australia look cheap! The duty-free program for cruisers has sadly been stopped, so the 75% duty on booze sure put a damper on things.

Every evening we had a total island experience, as we sat in wonder at the sight of hordes of paddlers, from one-man outriggers to eight-man doubles, going by. It was a never-ending procession that would culminate a couple of weekends later when hundreds of them competed against each other. All ages and sizes, all fiercely competitive.

We drove to the world famous Teahupoo surf spot for another swell, but again the wind was from the wrong direction, so we still haven't seen it go off. We continued to explore the island for another couple of days, and despite expecting a massive buildup, weren't prepared for the astronomical amount of it. There are now only a couple of pockets that look and feel like traditional Tahiti. The rest is modern, and four-wheel SUVs, the international symbol of having 'made it', were ubiquitous.

We had our own 'wogs on tour' moment when we decided to take our two headsails ashore by dinghy for repair. Halfway there, the small leak in the bottom opened up, and in came the water! At the same moment we noticed that our outboard tank was all but empty. Then Verdo's back went out. Gingerly we limped back to *Larrakin*, and laughed about it later when the sails were back on the boat and Verdo had an anti-inflammatory down his throat.

After patching our dinghy repeatedly for two years, we'd had enough. So there and then we decided to buy a new dink — and couldn't be happier. With the 'Boat in transit' tax back, it didn't turn out to be as expensive as we'd feared. She is getting pimped daily and should serve us for years to come.

We got through another week's work, and with new batteries, some electrics sorted out, and my fractured toe feeling better, we reprovisioned and left for the short sail to Moorea.

We're anchored off Moorea now, and again the buildup is astounding. The French, including lots of retirees, have moved down here in droves. As high as the prices are for everything, the lifestyle is superb, so we can't blame them.

We came to Moorea to catch up with Mimi, an old friend of ours, and her man Stefan. She's a local with a huge family that owns a big chunk of Pao Pao, Cook's Bay. We've anchored in front of her place on many occasions, and always left loaded with home-grown fruit and flowers.

There have been lots of big yachts at Moorea. Verdo says you know the world is awry when the private yachts are bigger than the navy's. Although they are absolute monsters, we're not jealous.

We have three more weeks of sailing amongst these stunning islands and will

A couple of beauties. There will be no question about what's for dinner tonight aboard 'Larrakin'. Good thing the freezer is working, too.



CHANGES

be off for Suwarrow atoll where the diving and surf are supposed to be exceptional.

— *gabby 08/15/2014*

Blue Marble — F/P 46 Cat Erlend Hovland On the Reef at Niue (Norway)

Thirty-two-year-old Norwegian marine biologist Erlend Hovland now fully appreciates the warnings about never trusting a strange mooring. Last month the Pacific Puddle Jumper's catamaran went up on a reef at Niue after the D-ring securing the mooring line to the mooring unscrewed itself — just after the young and fun-loving Norwegian crew of eight had gone to breakfast ashore. Members of the Niue YC had suggested they use the "commercial mooring". Niue does not have a harbor or safe anchorage.

Niue officials quickly launched a large commercial vessel which — incredibly — managed to drag the cat over and off the jagged reef. Despite considerable damage to the hull, *Blue Marble* was taken to the surgy waters next to the cement wharf, where a big crane, rushed to the scene, was able to lift her out of the water. There is great video available on the Sept. 13 *Lectronic Latitude*.

While not a total loss — *Blue Marble* looks perfect from the waterline up — it's unclear what can be done with the boat. The nearest yard is Tonga, but a lot of work will have to be done on the hulls before she is seaworthy. Fortunately, the cat was insured.

"Right now we do not know what will happen next," wrote Hovland on his website. "We are being taken care of by very friendly locals. All eight of us are living in the same house for the time being. Some might try to hitchhike westward as crew on passing yachts."

Hovland and crewmember Andreas Melvær had crossed the Pacific once before. It was 1987, and they were 5 and 3

Is there a more heartbreaking sight than a sailboat on a coral reef? The insured 'Blue Marble' was pulled off, but her future is uncertain.



BLUE MARBLE

respectively. "We were calling this a trip in the wake of history," Hovland wrote, "and have been documenting it with a media project."

— *latitude 09/15/2013*

Cruise Notes:

"We're just finishing our shakedown cruise from Thailand to California," report Santa Barbara's Mike and Annette Reed. "We bought **Rum Doxy**, our 46-ft cat, as a wreck in Phuket and spent five years redesigning and rebuilding her there. We launched three years ago, and have been drifting between Phuket and Langkawi, Malaysia, getting the boat ocean-ready. Last year we began the trip to California, getting the boat as far as Borneo before having to return home to work.

"We began the current leg of the trip in February," the couple continue, "making our way from Borneo to the Philippines, Taiwan and Japan. We left Japan in mid-June, and landed in Kodiak five weeks later. We have been making our way south ever since, with visits to Prince William Sound, Icy Bay, Yakutat and the Inside Passage. We are currently in Petersburg, and hope to be back in Santa Barbara in October to return to work. We plan to work for a couple of years while finishing the boat, which would allow us to stop being mobile boat-builders/delivery crew, and go cruising."

It sounds like the two have been cruising since before they started cruising. We're hoping to swing by Santa Barbara before the start of the Ha-Ha to get a few more details on what sounds to have been an excellent adventure. If 'doxy' is a new word to anyone — it was to us — it means floozy, prostitute or mistress.

If you're about to take off cruising and are concerned that you may not get enough cardio, you may consider taking along a **SUP**. These provide great exercise for hard-to-reach core muscles, and make exercise a pleasure instead of a chore.

Our first bit of advice is to consider getting an inflatable SUP. No, these aren't as good for surfing waves as are the solid ones, but they have come a long way. The ones that you can inflate to over 20 psi are pretty decent. Starboard makes inflatable versions of most of their many models. Some lower-cost and -quality inflatable SUPs are more suited for 'cruising', and some even come with seats, gear



INSETS ROBIN STOUT



racks and other stuff. When we did the Martinique-to-St. Barth trip with the Olson 30 **La Gabelle**, we used an 11-ft inflatable Uli SUP for our dinghy and our liferaft. In tropical waters, it worked fine as a dinghy. Fortunately, we never needed to try to use it as a liferaft.

There are two huge benefits that **inflatable SUPs** have over solid SUPs. First, you can roll them up into a compact package for when you are underway or if you need to take them on a plane for some reason. Even more importantly, because they are made of inflatable dinghy-like fabrics, you can drag inflatable SUPs onto your boat without scratching or dinging the boat or the SUP.

Our second bit of SUP advice is to make sure that you get one big enough for the biggest rider on your boat. We started out with a couple of boards that weren't big enough, and that ruined SUP-ing for us for years. We recently got the right size board, and it made all the difference in the world. After just a couple of days, we were pretty good at it, not falling, even in chop. While a big

IN LATITUDES



LATITUDE / RICHARD

Spread; There can be great surf in Mexico, such as at Punta Mita. If you're more senior, SUP cruising is a good cardio alternative. Top left; Doña de Mallorca shows how it's done. Being on a board too big for her isn't a problem. Bottom left; The Wanderer fails in an ill-advised attempt to hang ten.

person can't use a board that's too small, a small person — or two or three, plus a dog — can still have a lot of fun with a SUP that's too big to be ideal for them.

Remember how warming of the Arctic has made the once nearly impossible **Northwest Passage** feasible? Naturally it has attracted a lot more adventurous sailors in the last couple of years, including at least two dozen this season. But as Douglas Pohl reported in a recent *Sail World* article, these adventurers got a rude awakening when both ends of the Northwest Passage became blocked by ice early in the season. At least 22 yachts are said to be trapped until next summer — or even longer. It's unclear if the Canadian government will go to the considerable expense of sending an icebreaker to free them. In addition to 'yachts', there are some Jet Skis and row boats. Yes, someone wanted to be the first to say they Jet Skied the Northwest Passage. Some skippers have already

abandoned their vessels. What's the problem? Pohl reports that there is 60% more ice this year than last.

Kirk McGeorge reports that he and his Hylas 49 **Gallivanter** are well on their way from Darwin, Australia to their 'new old home' of St. Thomas in the U.S. Virgins. He's made it to Komodo Island in Indonesia, home of the Komodo dragons. While the big lizards are nasty looking, they don't usually kill from their bites, but rather from the highly toxic bacteria in their saliva. After they bite their prey, they follow them until they get sick and die. Kirk is trying to make fast passages, because he'll be meeting up with his wife Kath and son Stuart at Cape Town and later the U.S. Virgins.

We wouldn't be surprised if Kirk and crew bumped into Gene and Sheri Seybold of the

Stockton- and Honolulu-based **Esprit 37 Reflections**, as they were checking out the Komodo dragons on Komodo Island at about the same time.

"*Latitude* recently asked about low or 'no money' months of cruising," write Chuck and Linda Houlihan from aboard the Allied 39 **Jacaranda** in Ecuador. "We departed San Diego in 2005 and have had a number of 'zero dollars spent' months. The longest we've gone without spending any money is six weeks at the Socorro Islands 250 miles southwest of Cabo. It was easy because there wasn't anywhere to spend money. The first time we spent 3½ weeks out there, the second time six weeks. Back in the late '80s while I, Chuck, was cruising in the South Pacific, I had a couple of zero-dollar months as well. They were few and far between, but they were nice when they happened.

"During the four summers we spent in the Sea of Cortez, there were numerous times when we only spent \$50 or \$60 a month," the couple continue. "One year we only used 10 gallons of diesel in making the 600-mile round trip from La Paz to Bahia de Los Angeles over a 3½-month period. Something like \$50 a month is all you need once you get north of Santa Rosalia, because there are no marinas or major towns with stores to suck *pesos* from your pockets. One major key is knowing how to fish and collect edible seafood. I, Chuck, did the fishing, while Linda did the collecting. We enjoyed fresh seafood every day. Not breaking boat stuff — which is easier said than done — helps keep you within your budget."

"I cruised for four years in Mexico on 4,000 *pesos* per month," reports Chuck Losness of the Gulfstar 41 **Hale Moana**. "It wasn't hard to do, so I don't know what the big deal is. You just can't stay in marinas. I'm back in San Diego now and expenses have gone up, but not by that

Two fresh and filling roosterfish tacos, with hot and mango sauces, on the water at La Cabana at Punta de Mita. About \$6. Yum de dum!



LATITUDE/RICHARD

CHANGES

much. What you spend is all a question of lifestyle."

At the current exchange rate, 4,000 pesos is about \$305 U.S. Come to think of it, that's what Bill Anderson of the home-built Hughes 42 cat **Feet** recently told us he spends a month cruising in Mexico, where cruising can be very inexpensive.

"We recently arrived in the Society Islands," report Justin Jenkins and Anna Wiley of the San Diego-based Columbia 34 **Ichiban**. "We've been at Huahine catching epic barreling surf. Incredible! Sorry we didn't write sooner, but it's hard to find Internet access. We just caught a 60-lb mahi mahi and will send a photo as soon as we can."

As *Latitude* reported last month, Jenkins and Wiley, both in their early 30s, paid \$2,000 for their boat — not counting upgrades — and took off for the Marquesas with just \$400 left in the kitty. While pointing out that it really is possible to cruise happily on very little money, we don't want to mislead anyone about what most people spend when they cruise. We'd say that for folks who have



LATITUDE/RICHARD

When it comes to cruising boats, the general rule is the bigger the boat, the bigger the budget. And exponentially so.

already paid for and equipped their boat, the monthly nut is somewhere between \$1,500 and \$4,000 to live a pretty sweet cruising life. It's certainly possible to do it for less, but we also know of folks who are going through \$10,000 a month.

"We're anchored at Pago Pago, American Samoa," reports Michael Moyer of the Newport Beach-based Alajuela 48 **Cherokee Rose**. "Everyone claims this is *the* place to reprovision and send your broken parts back to the States. Buses run constantly during the day, \$1 each way, and if you tell the drivers where you need to go, they'll usually drop you off in front of whatever building you want. The post office looks just like the ones in the States — because it's exactly the same postal service. I've sent items back to California and mail-ordered parts from the States. Although I haven't gotten anything back yet, I'm told it will be no problem. The anchorage here is as bad as advertised, as almost everybody has had to reset their anchor at least once. Ours held for four days and in up to 27 knots of wind, but even though it only blew 17 knots on day five, we dragged through the fleet. What can I say? We're off to try to fill an older propane tank. I'm keeping my fingers crossed that they don't make me replace it."

"I read about **Profligate's** five-day-



KISS High Output Wind Generator

Four amps at 10 knots, 10 amps at 15 knots; guaranteed to hurricane-force winds; electric brake and built-in thermal protection; mizzen, arch, or pole mount; three-year warranty. See our website for improvements/upgrades.

MADE FOR CRUISERS!
Powerful, quiet and simply designed.

HofWire

SOLAR PANELS • CHARGE CONTROLLERS • LED LIGHTS • MUCH MORE

HOTWIRE ENTERPRISES • www.svhotwire.com
svhotwire@gmail.com • P/F: 727-943-0424 • Cell: 727-638-7417

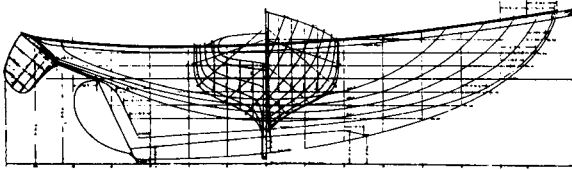

MAKELA BOATWORKS
Family owned since 1948

Wooden Boat Building • Repair and Restoration

19280 South Harbor Drive • Fort Bragg, CA 95437
(707) 964-3963
email: howard@makelaboatworks.com • www.Makelaboatworks.com

Welcome to La Paz!

MARINA DE LA PAZ
FULL SERVICE MARINA

IN DOWNTOWN LA PAZ

*Friendly, helpful,
fully bilingual staff*

Official Sponsor
2013
BAJA
HA-HA

Join us for the
BAJA HA-HA BEACH PARTY
Wednesday, November 20
4-7 pm

Hardwood docks • Dinghy landing
Protective piling & sheetpile breakwater
Plug-in Internet • Cruisers' clubhouse • Electricity
Potable reverse osmosis water • And more!

TEL: 01152 612 122 1646
email: marinalapaz@prodigy.net.mx
www.marinelapaz.com
Apdo. Postal 290, La Paz, 23000
Baja California Sur, Mexico

plus-a-couple-of-hours Bash from Puerto Vallarta to Ensenada," reports David Addleman of the Monterey-based Santa Cruz 50 X. "It's nice when the Bashes are easy. I once did a January delivery from Acapulco to San Francisco, and we didn't take a single drop of water on the deck. But it did take a month, as we stopped at almost every *cantina*. There's no news to report from X here in the Philippines as it's the wet season, although for a wet season there have been a remarkable number of sunny days. Nonetheless, cruising is out of the question as typhoons regularly roar through the area. My days are spent on minor boat maintenance, currently the interior varnish. Evenings are passed at the Rock 'n Roll Bar and related antics. There's a regatta here in November, after which we'll resume wandering around the Philippines."

"After three months in the beautiful San Blas Islands of Panama, we're still in Panama planning to transit the Ditch at the end of September and then work our way north to Mexico," report John

and Deb Rogers of the San Diego-based Deerfoot 2-62 **Moonshadow**. "While in the Caribbean, we twice ignored the advice the Wanderer gave us when we met up at St. Barth, and both times we learned our lesson. First, we checked in on the Dutch side of Sint Maarten instead of going around to the French side of St. Martin. Mistake. Second, we should have stayed in St. Barth longer. These were huge screw-ups on our part. Inexcusable, really, as they don't pass out titles like Grand Poobah willy-nilly, do they?"

We may not know much, but we do know about checking into and out of St. Martin/Sint Maarten, and we do know why St. Barth, if you understand the little place, ranks so high among the islands of the Caribbean.

"I recently returned from nearly three months in French Polynesia aboard **Marionette**, a Nils Lucander-designed



If you know where to go in St. Barth, you run into the nicest people — such as Dewey and Darlene Hines of the St. Francis YC and the classic Rhodes 55 yawl 'Ocean Queen', built by Abeking & Rasmussen and vet of the first ever St. Francis Big Boat Series. The couple were nice enough to pose with the Wanderer's 'tender' to 'ti Profligate', a Yamaha TW200.

50-ft cutter that was built by Cheoy Lee," reports Don Furber of the Eureka/Puerto Escondido-based Ericson 36C *Calliope*. "Marionette was purchased several years ago in the San Francisco area by Bruce and Catherine Dunlop of New Zealand.

 A large advertisement for a beach party. The background is a sunset over a body of water with a large bronze statue of a man in a cape. The text reads:

Welcome to La Paz
Baja Ha-Ha
 Beach Party at La Costa Restaurant
 WEDNESDAY, NOVEMBER 20TH. | 4:00 - 7:00 PM
 Mexican Folk Dancing • Live Music • Food & Drinks

FREE for first fifty!
 (2013 baja ha-ha participants.)
 Door prizes and much more!

www.golapaz.com



CHANGES

After several months of work — including replacing bad wood in the stern and cold molding two diagonal layers of Alaska yellow cedar over the original strip planking — they sailed her to Baja. I met the Dunlops in Puerto Escondido, where I keep my boat. After a couple of seasons getting acquainted in the Sea of Cortez, I put in my bid to crew for Bruce when he was heading back to New Zealand. Fortunately, that worked out. We left San Jose del Cabo at the end of April and made landfall in the Marquesas 18 days later. We had several 180- to 190-mile days under sail, and resorted to power for only about 55 hours. Life aboard the 50-year-old woody was comfortable no matter what the weather. We were, of course, sailing off the wind."

"On the way to the Marquesas," Furber continues, "we saw what seems to me to have been a very unusual occurrence. I've always enjoyed watching the sun change shape as it sinks into the sea, but on May 8 it was different. It quickly became apparent that we were seeing a partial solar eclipse. I want to know: 1) Did this happen around the



DON FUBAR

Here's something you can't see often, a partial eclipse as the sun is about to set into the ocean. Plus just a tip of the sun on the left as a bonus.

globe for everyone in the same band of latitude? 2) Does it happen every month somewhere? 3) Can you plot where you need to be to see another? 4) Has anyone else seen one at sea?

"Lastly, thanks to *Latitude 38* for putting in the time and energy to facilitate

entry into French Polynesia for cruisers. We weren't able to participate in the Puddle Jump fun at Moorea because of a conflict with crew departure schedules, but our greeting in Papeete and Coralie, the agent, were both excellent."

Thanks for the kind words. Andy 'Mr. Puddle Jump' Turpin, managing editor of *Latitude*, is the person at *Latitude* who has been entirely responsible for the greatly improved clearing procedures for cruisers going to French Polynesia. And yes, it's taken a lot of time and effort.

As for your eclipse questions: 1) Others would have seen the eclipse, but not necessarily those at the same latitude. 2) There are two to five eclipses a year, although five is rare. 3) Where eclipses can be seen is known well in advance, allowing umbraphiles — those who travel to see solar eclipses — to know where to go. 4) We once saw a near-total eclipse from the docks of the Ala Wai Yacht Harbor in Honolulu. Those on boats at Lahaina would have seen a rare total eclipse. We also saw a surprise eclipse while flying home from Honolulu once.

JUST YOU AND THE SEA...

...and the jacuzzi,
the 80-ft long pool, the surf,
the Punta Mita anchorage, and the 4-mile distant
Tres Marietas Islands

Punta Mita Beachfront Condos
Call Doña de Mallorca for reservations!
1.415.599.5012
www.puntamitabeachfrontcondos.com

Re-entry to the 'real world' hasn't been without hiccups for Pamela Bendall of the Vancouver, B.C.-based Kristen 46 **Precious Metal**, who took off cruising with the Ha-Ha in 2008 and adventured as far south as Peru. For example, a day or so after she and her boat returned home to Vancouver, she parked her dinghy, locked it, and went to dinner. When she came back two hours later, it was gone. "After five years of cruising in waters and to countries that are supposedly rife with crime, my dinghy gets stolen in Canada," she groaned. An orange bag was found near the scene of the crime, and it contained a crumpled beer can, a battery-powered grinder, and a sharp rotary blade to cut the dinghy's lock and chain. In the better news column, the folks at Hub Insurance not only approved Bendall's claim — despite the fact she'd only taken out the policy the day before — they also waived the 30-day waiting period to pay the claim.

"It's amazing how different our Canadian society has become in the five short years I was gone," Bendall continues.

"I was pretty hip and savvy when I departed, but while on my doggie walk yesterday I witnessed a scene that I wouldn't have seen five years ago: a lesbian couple getting married in a lovely public setting along the shoreline, with family and friends gathered around in delight. I appreciated the scene, too — until both women pulled out their smart phones to read their vows to each other! Yup, they scrolled down their gadgets as they read each passionate line." Not that there's anything wrong with it.

Plan A for Jack van Ommen and his Gig Harbor, Washington-based Nadja 29 **Fleetwood** was to leave Amsterdam for England, Portugal and the Canary Islands, where he would make a December jump-off for the Caribbean and Cartagena, Colombia. From there, he would begin his explorations of South America. But a combination of not being



Sixty-five years old and unable to pay his rent in 2002, the amazing Jack van Ommen has now sailed over 40,000 miles and cruised to more than 40 countries — all on modest monthly Social Security checks. He's seen here with one of his daughters and his intrepid built-from-a-kit Nadja 29 'Fleetwood'. What an inspiration!

able to get everything ready on his boat after putting on new decks and doing an extensive refit, plus the onset of bad weather, put an end to that plan. "I was having trouble getting SailMail set up on my new laptop, I wasn't able to get the AIS working, and then the marina *Fleetwood* was in was hit by winds up to 53 knots. That humbled me back to



SPECTRA

WATERMAKERS

Making fresh water world wide

Adventure Awaits

Let us help you find it



www.swedishmarine.com



www.outboundyachtservices.com

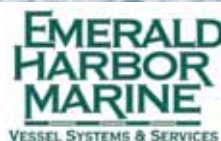

www.emeraldharbormarine.com



www.seatechmarineproducts.com

CHANGES

better sense, as I also needed to take a closer look at the condition of the spreaders, which hadn't looked so good when I re-stepped the mast 10 days ago. I am disappointed because Plan A would have been a good sail, but I was trying to leave too late in the year, as the pleasant weather of summer has been replaced by the stormy conditions of fall in this part of the world. There are a number of new depressions coming down from the north. My Plan B is to take the mast down again, repair the spreaders, and then get to the Med via the canals — which is the same way I came up to Amsterdam last August/September. It's definitely a slower and more costly way to make my way to the Canaries, and I am not particularly looking forward to the 200+ locks *Fleetwood* must go through, but I will be passing through Burgundy during the grape harvest and will get to taste the new Beaujolais. I should be able to get back on the schedule for leaving the Canary Islands in November/December for my Atlantic crossing. This delay reminds me of the time I got stranded in Port Townsend in October 2004 with too



JEAN JACQUES

Plan B will see van Ommen taken 'Fleetwood' down to the Med via the canals of France. There will be 200 locks to negotiate, but no big seas.

many loose ends, and the time I missed the window to cross the Atlantic in 2008 after I spent too much time doing work on the boat in Florida."

Van Ommen, now well into his 70s, is one of the most accomplished 'big bang for the buck' cruisers we know. You can

follow his many adventures at <http://www.cometosea.us>.

"**Capt. Ron' Drew**, a daily presence on the morning Cruisers' Net on Banderas Bay, and a frequent visitor to the various marinas to pick up clothing and other donations for The Single Mom's Association, passed away in August," reports Steve van Slyke. "Capt Ron's history in Puerto Vallarta and Banderas Bay goes all the way back to the days when coastal freighters would anchor off downtown and small boats would off-load bananas. It was a long time ago."

It's hard to believe, but we're on the eve of **another great cruising season**. Although we just got back from Mexico in early September, we're dying to return. The chance to make more great new cruising friends, to mingle with the wonderful people of Mexico, to enjoy the warm water, and to get in some long spinnaker runs — just a few of the many things we're looking forward to. We won't even mention all the cruising fun starting in the Caribbean in mid-February. It's like the song says, "Winter, it's my time of year."

eMarine Systems

- Solar panels
- Wind generators
- Hydro-generators
- Inverters/ battery chargers
- Mounting systems
- Meters and accessories

Authorized wind generator and inverter service center

Ft Lauderdale, FL
954-581-2505
www.eMarineSystems.com

RIGGING ONLY

since 1984

STANDING RIGGING - RUNNING RIGGING
LIFELINES - HALYARDS - CLUTCHES
ROLLER FURLING - WINCHES - BLOCKS
DECK GEAR & MORE...

Official Sponsor
2013
BAJA
HA-HA

508-992-0434
sail@riggingonly.com

WWW.RIGGINGANDHARDWARE.COM

Specializing in Complete Packages

SEATECH SYSTEMS™

800.444.2581 • 281.334.1174
info@sea-tech.com • www.sea-tech.com

Navigation, Communication & Weather

After hours pick up and drop off available.

Specializing in Sail Repair and Service.

Marchal Sailmakers

2021 ALASKA PACKER PLACE, ALAMEDA, CA 94501
Dominic Marchal • (510) 239-5050
www.marchalsailmakers.com

Your Boatyard in the Heart of Paradise



Large, fenced, secure dry storage area

Tahiti Customs policy has changed!
Foreign Flag vessels can stay on dry storage in our yard for up to 12 months out of 24.



A Subsidiary of
The Moorings Yacht Charter, Ltd.

Our Services |



Professional boatyard in the heart of Paradise

*Raiatea Carenage will make sure
paradise is everything you expected.
Call, write, or sail in . . . we're here to serve you.*

B.P. 1111 Uturoa Raiatea 98 735 Polynésie Française
Tel: (689) 600-545 ~ Fax: (689) 600-546 ~ VHF 68
Web site: <http://www.raiatea.com/carenage> ~ email: raiateacarenage@mail.pf

HAULOUT

- Marine Travelift 25 tons
- Marine railway 120 tons
- Storage in adjustable steel cradles
- Fenced Yard

PAINTING

- Topsides, hull, bottom, varnish
- Brush, roller, spray

MECHANICAL WORK

- Inboard, outboard, diesel, gas
- All brands

REPAIRS

- Electrical repairs
- Refrigeration installation & repair
- Fiberglass & woodwork
- Welding, steel, stainless, aluminum

SAIL LOFT

- Sail repairs, biminis, dodgers, covers

STORE

- International, Pettit, Epiglass, Devoc
- Spares
- Fill U.S. gas cylinders

DO-IT-YOURSELFERS WELCOME!

BoatUS Cooperating Marina

KATADYN SURVIVOR 35 WATERMAKER

The Survivor is a must for all sea-going vessels and is the most widely used emergency desalinator. It is used by the U.S. and international forces. It is able to produce 4.5 liters of drinkable water per hour.

Reconditioned by Katadyn **\$950**

Also available:

- New Katadyn Survivor 35: \$2195
- New Katadyn Survivor 40-E: \$3695
- New Katadyn Survivor 80-E: \$4695



EQUIPMENT PARTS SALES

In the U.S.: (800) 417-2279 • Outside the U.S.: (717) 896-9110
email: rod@equipmentpartssales.com



1,000 Used Sails
Listed at
minneysachtsurplus.com

**We Buy Good Used Sails
and Marine Equipment**

MINNEY'S YACHT SURPLUS

1500 Newport Bl., Costa Mesa, CA
949-548-4192 • minneys@aol.com

"We keep boating affordable!"



MARINE BATTERIES



Available at the following local marine chandleries and service distributors:

- | | |
|---|---|
| ALAMEDA
The Boatyard at Grand Marina
Star Marine
Svendsen's Chandlery | MARTINEZ
Martinez Bait & Tackle |
| BENICIA
Cruising Seas Services | OAKLAND
Outboard Motor Shop |
| EMERYVILLE
Mathiesen Marine | OAKLEY
Big Break Marina |
| | RICHMOND
Swedish Marine
Bay Marine |



AMERICAN BATTERY • Hayward, CA • (510) 259-1150
See us at Marina Village BoatFest • October 3-6

WEDLOCK, RAMSAY & WHITING

Marine Surveyors

Vessel surveys,
consulting, deliveries.

Serving the
Bay Area
since 1980



www.norcalmarinesurveyors.com

(415) 505-3494

Please read before submitting ad

Classy CLASSIFIEDS

Here's What To Do:

Write your ad. Indicate category. Remember price and contact info. We make final placement determination.

Count the words. Anything with a space before and after counts as one word. We will spell-check, abbreviate, edit, as necessary.

Mail your ad with check or money order, deliver to our office; **OR, for the best – and most exposure – of your classified ad...**

Submit your ad safely online with Visa, MasterCard or AmEx at: **www.latitude38.com**

Ad will be posted online within two business days, appear in the next issue of the magazine, and remain online until the following issue is released.

PERSONAL ADS

1-40 Words.....\$40
41-80 Words.....\$65
81-120 Words....\$90
Photo.....\$30

• Personal Advertising Only •
No business or promo ads except Non-Profit, Job Op, Business Op

'Trying to Locate' Ads are for those searching for lost boats/people – not shopping – and cost **\$10 for 20 words max**

FREE Online Ads are for a private party selling a boat for less than \$1,000 – or gear totalling under \$1,000. (One per person; must list prices in ad.)

All ads will be set to fit *Latitude 38* standard • Re-Run Ads: Same price, same deadline

BUSINESS ADS

\$70 for 40 Words Max

• All promotional advertising •
1 boat per broker per issue
Logo OK, but no photos/reversals
No extra bold type • Max: 12 pt font
Artwork subject to editor approval.
Biz ads will not appear on website.

DEADLINE

it is **ALWAYS** the **15th at 5 pm**

for ad to appear in the next issue.

Due to our short lead time, deadlines are very strict and include weekends & holidays.

Sorry, but...

- No ads accepted by phone
- No ads without payments
- No billing arrangements
- No verification of receipt
- We reserve the right to refuse poor quality photos or illegible ads.

Latitude 38 15 Locust Ave, Mill Valley, CA 94941 Questions? (415) 383-8200, ext 104 • class@latitude38.com

WHAT'S IN A DEADLINE? Our Classy Classifieds Deadline is the 15th of the month, and as always, it's still pretty much a brick wall if you want to get your ad into the magazine. But it's not so important anymore when it comes to getting exposure for your ad. With our online system, your ad gets posted to our website within a day or so of submission. Then it appears in the next issue of the magazine. So you're much better off if you submit or renew your ad early in the month. That way your ad begins to work for you immediately. There's no reason to wait for the last minute.

9-FT PORTA-BOTE DINGHY/TENDER. \$600. Folding portable boat. Stable, dry, rows well; nice wood oars included. Planes fast with small outboard. Unsinkable, durable. Easy to transport on land or sea. See website for pics and more. tinyurl.com/pb4sale. (707) 696-2230 or s_cox2@yahoo.com.

WEST MARINE SPORTS DINGHY. RU260, \$1,500. RU260 8' 6" x 4' 7". Carrying capacity 595 lbs., 2-4 persons. Weighs 55 lbs. in carrying case. Pump and oars included. Dinghy used one time only for 1/2 hour in the harbor. Yamaha 4hp. Runs perfectly. (415) 987-1942.

VIKING RESCYOU PRO. 6-man liferaft, Alameda, CA. \$2,500. RESCYOU Pro 6UKSL, 6-man self-righting liferaft, never deployed, excellent condition, repacked 08/2013 certified through 2016, USA offshore E-pack, ISO 9650 compliant and comes with nylon valise. (206) 890-3012.

14-FT ACHILLES, 1992. Benicia. \$4,975. 30hp Yamaha outboard. Sit-down/stand-up steering. Lowrance depth/fish finder, VHF, Aluminum floor, Danforth anchor, 10-gallon tank. Great fishing or dive boat. Excellent condition. Calkins trailer with spare. Contact (831) 809-2700 or sdavidenterprises@gmail.com.

19-FT WEST WIGHT POTTER, 2010. Alameda. \$13,500/obo. Don't miss out on beautiful fall sailing! Sweet boat, clean and ready to go. Premium package with upgrades. 2011 Honda 4hp. Bottom cleaned 8/30/13. In the water, no trailer. Email suevee10@yahoo.com.

24-FT MOORE, \$13,600/ASKING. Excellent condition; very complete. Lots of new gear and extras. Hull 64. New Awlgrip paint, new main and spinnaker (1 regatta). Underdeck hatch, Barney post mainsheet. Call to view photos or see boat. (650) 462-1640 or email bernardsaggese@sbcglobal.net.

DINGHIES, LIFERAFTS AND ROWBOATS



10-FT CARIBE C-32, 1999. Alameda. \$1,500. Includes Nissan 15hp outboard, canvas bag, inflation pump, oars and gas tank. Soft bottom dinghy with fiberglass keel and floorboards stows compactly, sets up quickly, easily carries four adults with gear. Contact (510) 390-5727 or carribec32@outlook.com.



15-FT FINN, 2008. Union City. \$13,500. HIT mast, lateen mast, Needle Spar boom, many sails. Tacktick compass, Carbone Hiking extender, deck cover, hull cover. Mast, boom, rudder, centerboard and tiller cover. Devoti trolley. Roll on and off trailer. Box with spare parts. The boat is ready to race and travel. (510) 299-1756 or Hgrygiel@aol.com. 1058 Moonstone Terrace.

24 FEET & UNDER



18-FT FLORIDA BAY MUD HEN. City of Sonoma, CA. \$3,000/obo. Fiberglass gaff-rigged catboat, tanbark sail good condition. Galvanized trailer, swingaway hitch. Canvas canopy, wraparound teak benches. Spruce oars, outboard motor well, retractable centerboard. Beautiful! www.sailingtexas.com/cboats99mudhen.html. Contact (415) 405-6148 or Blunk.6@osu.edu.



24-FT SEAWARD, 1990. Brookings, Oregon. \$10,900. New 8hp 4-stroke electric start remote Tohatsu, bimini, Porta-Potti. Main, furler genoa, icebox, 30 gal water, Delta anchor, SS portholes, solar, fish-finder, mast raiser, propane stovetop, foot pump, tandem aluminum trailer. Photos available. Contact (541) 469-9379 or jeannine.heriford@frontier.com.

WOODRUM MARINE

Specializing in custom interior cabinetry, tables, cabinets, countertops, cabinsoles. For power or sail.

CARPENTRY
Mobile cabinet shop
Contact Lon Woodrum at:
415-420-5970
www.woodrummarine.com

N.E. MARINE TITLE

Coast Guard documentation • Title/lien searches • Transfers • Mortgage filing • Escrow services
Local closing facility for brokers or private transactions
30 years experience of doing it right the first time

1150 Ballena Blvd, Alameda, CA • (510) 521-4925



NOR-CAL COMPASS

Adjustment • Sales

Authorized Compass Repair

Hal McCormack • norcal.compass@verizon.net • Phone/Fax (415) 892-7177

Capt. Alan Huguenot • (415) 531-6172 • Accredited Marine Surveyor

ASA Certified Offshore Sailing Instructor

Power boat handling & docking, single or twin screw,
35 years sailing sloops, ketches, schooners & catamarans
SF Bay or Coastal • Accepts all credit cards





20-FT ULTIMATE 20, 1995. Redding, CA. \$20,500. UFO, #27, well known Ron Moore built U20. C-Tech carbon mast, 2012 Doyle Boston main, 2013 Doyle Boston jib, both light use. 2008 UK main and jib. Glaser and Ullman kites. Tacktick compass, Velocitek Speedpuck. New tiller, new main halyard. Mainsail cover and jib sock. Tapered jib and spinnaker sheets. 2009 Honda 2hp. Cockpit cushions. Great boat with excellent trailer. (530) 241-3685 or jwpcartwright@gmail.com.

24-FT KENT RANGER SAILBOAT, 1978. Coyote Point. \$1,500. Evinrude 2-stroke 6hp outboard, sails, full flotation, Burma teak, stainless shrouds, stays, aluminum mast and 8'4" boom, fiberglass laminates: hull, deck, interior, rudder, need TLC. Sails well. Contact (408) 561-5399 or woolleyre@yahoo.com.

24-FT J/24, 1978. \$6,500. TP built, vermiculite job, main bulkhead replaced, Dyform standing rigging, calibrated turnbuckles, windward sheeting, roller stations all at minimum height, 8-1 boom vang, Ullman class sails and two-axle trailing with gear box. Fun fast boat. (209) 603-7991 or ccorbin@costco.com.

15-FT POTTER, 1983. San Diego, CA. \$2,500. Furling jib, 5hp Nissan, dodger, semi-enclosed cockpit, reconditioned trailer, spinnaker, anchor, solar panel, Sea Swing stove, cockpit reefing, oars, ladder. (619) 339-1152.

19-FT DORY, 2008. Fort Bragg, CA. \$8,000. Pamela G., a wood dory built by a team led by Eijler Hjorth Westh, two sets oars; new trailer Also, Feathercraft kayak, bag, paddles, seat, flotation, 2001 K-Light Plus, excellent condition; \$1,400. (707) 234-9331 or mheath@pacific.net.

25 TO 28 FEET



25-FT FOLKBOAT-DEBUTANTE, 1960. Alameda Marina. \$6,000. Brandt Mueller design, mahogany on oak, full boat cover to waterline, Evinrude outboard, needs some work. (415) 640-3257 or (510) 339-0302 or dalenby@pacbell.net.

27-FT ERICSON, 1977. San Francisco. \$5,000. Rare factory wheel. Roller furling jib, lazy jacks, 2-speed winches. All lines back to the cockpit. Bimini. 8hp outboard. Very good condition. Call Joe. (415) 810-6474 or (414) 285-8453. Or email patriciapolen@earthlink.net.



28-FT WYLIE CUSTOM, 1982. Richmond. \$24,000. Singlehanded ocean racer or fast Delta cruiser. Built by master shipwright. 2nd owner, Bristol condition. Custom mahogany interior. 7 bags of new racing sails plus good offshore cruising sails. Self-tailing winches, 35-gallon water tanks. New: standing rigging, lifelines, high-output alternator, solar, 6v Trojans, nonskid, bottom paint, carbon fiber rudder, Delrin rudder bearings, Airex spinnaker, chain plates. Autopilot, Pioneer stereo. Many more upgrades. 1st Place for "Best Singlehanded Boat" 2013 Plastic Classic. Contact (707) 484-9486 or winefood@sonic.net.



25-FT CAPE DORY 25D, 1983. Santa Cruz. \$23,950. Carl Alberg's best small cruising design and CD's legendary quality. Head in forepeak creates spacious main cabin. Full keel, attached rudder. Stiff, comfortable, perfectly suited to Bay or blue water cruising. Deck-stepped mast/stainless tabernacle. New standing/running rigging. Fresh bottom paint. Topsides buffed/waxed. Barient bronze self-tailing sheet winches. Hood 120 genoa on furler. Vector main/double slab reefing. Knotmeter, depth sounder, VHF. Stainless bow/stern pulpits with new lifelines. Bronze opening ports plus many custom bronze fittings. Full dodger, sailcover, cockpit, toerail covers. 25-pound Mason anchor. New 12-volt batteries. Yanmar 1GM diesel runs perfectly. Numerous Baja cruises. Custom double axle, galvanized trailer. More at <http://picasaweb.google.com/d1trout/Stargazer>. Contact (530) 941-2753 or D1trout@gmail.com.

27-FT CATALINA, 1982. Delta. \$7,900. 135% roller furling, autopilot, wheel steering, Atomic 4, cockpit cushions and folding table, pictures available, a must-see at this price. (707) 469-9163 or (925) 698-1100 or upde@comcast.net.

27-FT CATLINA, 1981. Sausalito. \$5,500. Custom tan interior and black canvas including winter cabin/cockpit cover. Comfortable Bay sailer and overnighter. New standing rigging and bottom paint 2010. Both bottom and Atomic 4 professionally maintained. Sailed often. Contact for pictures: jfroy@pacbell.net or (530) 622-2673.



25-FT OLSON, 1985. Sausalito. \$15,000. Santa Cruz built hull #45, in excellent condition, single owner, 2 full suits of sails (one Kevlar), Autohelm, recent bottom paint, new 4-stroke Mercury outboard, trailer (needs some work). Contact (415) 383-3471 or j-k-kitterman@att.net.



27-FT ERICSON, 1971. Alameda, CA. \$6,500. Good looking boat. Fresh paint on topside. Excellent running Atomic 4. Interior clean, in good shape. Stove, sink, icebox. Stays 5 years old. Bottom paint 4 years old. Main sail "like new". 4 jibs. (510) 415-4306.

26-FT MACGREGOR 26X, 2000. Santa Cruz. \$16,000. Very good condition. Suzuki 4-stroke 50hp motor. Mainsail, overlapping jib, genoa, and spinnaker. Includes trailer. Comes with many aftermarket upgrades. Low engine hours. (831) 234-7594 or emery.laurie@gmail.com.

COLUMBIA 28 MK II, 1970. Crescent City, CA. \$7,900/obo. Columbia with trailer. Upgrades. Decent sails, Autohelm, head, fridge, stove, water, recent upholstery, 25hp diesel. Recent bottom paint. Boat/trailer in good condition. See Craigslist ad for details/photographs. (541) 941-2042 or nwbiolog@gmail.com.

27-FT BRISTOL, 1966. San Carlos, Mexico \$2,900/obo. Sailed from SF when I was 22, cruised Baja >10yrs. Classic design, sails great. Needs TLC. Fix her up, go explore Mexico. Perfect for young person with time, but limited funds. More at <http://bristol27baja.blogspot.com>. Email dktatr01@yahoo.com.



25-FT ERICSON, 1976. Santa Cruz. \$6,500. Great condition! 3-year-old Honda 5hp outboard with few hours. Roller furling jib. Fixed keel. Boat is fully equipped with Life Sling, jackets and cushions. Beautiful teak interior. Marine radio, Ritchie compass. (831) 818-7171 or steve@brenner.com.



26-FT MACGREGOR D, 1987. Santa Cruz. \$5,800/obo. Good condition, trailer included. Sleeps 4-6 people. Pop top with side curtains. Daggerboard water ballast model. Upgraded sail inventory: 1 mainsail, 2 jibs, 1 genoa, 1 racing spinnaker. Harken windward sheeting. Newer shrouds with turnbuckles, newer stainless spreader bars. With 2008 Tohatsu 9.8hp 4-stroke outboard engine, extra long shaft, push electric starter, pull start, very low hours. (831) 600-5882 or (831) 706-7845 or Hooliaana@sbcglobal.net.

27-FT ERICSON, 1976. Brisbane. \$6,750. Great condition. Tiller, lines led aft, quarter berth, galley with stove, V-berth, head, large salon. Inboard Atomic 4 rebuilt by List Marine for 9k, <80 hours. Harken roller, Hood Vectran main and jib cost 8k + spinnaker. Email whackel@yahoo.com.



25-FT PACIFIC SEACRAFT, 1976. Tiburon. \$10,950. Great pocket cruiser! Full keel w/cutaway forefoot. Reliable inboard diesel. Nice interior. Decent main, 100% & 120% jibs, near-new spinnaker. Fuel, water tanks replaced. New bilge pumps, VHF, stereo, head, thru hulls. Sweet. Email solstice100@gmail.com.

28-FT ALERION EXPRESS. Sausalito. \$70,000 (1/2 of new price). Spinnaker, genacker, GPS, holding tank, radar, autopilot, all lines led to cockpit, lifelines. "The prettiest girl on the dock." (415) 302-7490.



RIGGING ONLY ◊ SMALL AD, SMALL PRICES

Standing and running rigging, life lines, furling gear, winches, line, windlasses, travelers, wire and terminals, blocks, vangs, and much more.

~ Problem solving and discount mail order since 1984 ~

www.riggingonly.com • (508) 992-0434 • sail@riggingonly.com

Afterguard Sailing Academy

The Affordable Way to ASA

ASA Basics to Ocean • Crew Intro to Cruising Prep
(510) 535-1954 • www.afterguard.net



STARBOARD YACHT DELIVERIES



Over 50,000 sea miles • Pacific, Caribbean, Atlantic
USCG Master 100 GT STCW • Power & Sail

Rick Whiting • (415) 740-2924 • captain_rick@sbcglobal.net

MARINE SURVEYOR

Sharpe Surveying & Consulting. SAMS Accredited Marine Surveyor.
Serving the San Francisco Bay and Delta.

RSharpe@SharpeSurveying.com • (510) 337-0706

BOAT WANTED. Looking for Catalina 34 Mk II or 36. Must have full batten main. 1999 or later. Contact (415) 250-1968 or rtoller@comcast.net.

32-FT DREADNOUGHT, 1982. Stockton Sailing Club, Stockton. \$21,500/obo. Not running, needs transmission replaced, have replacement. Boat has sat for a couple of years. SSC, B-33. (209) 823-5033 or jimsvos@comcast.net.

32-FT WESTSAIL, 1971. Marina Bay Yacht Harbor. \$10,000/offer. Ketch rigged. 50hp Perkins. Selling as is. (707) 887-2644.



33-FT JEANNEAU SUNFAST 3200. 2009. San Diego. \$145,000. Veteran of Pacific Cup Doublehanded, Transpac and Cabo. Turn-key ready for 2014 Pacific Cup doublehand or SHTP. Excellent condition with many extras. Full details and photos on website: www.mechdesign.com/3200. Contact (435) 640-0587 or sail@mechdesign.com.

33-FT SPAULDING, 1969. \$19,900. Quick, balanced, designed by Myron Spaulding, highly regarded Bay Area designer and sailor. 9th built with finest materials by talented pattern maker Ivan Davies. More info at en.wikipedia.org/wiki/Myron_Spaulding and www.spauldingcenter.org/myron-spaulding.html. Photos at http://plus.google.com/photos/107257849662934202751/albums/5901004776320496369?authkey=CJCU_e2mzdShDw. For more info email jonah_ward@hotmail.com.

32-FT CATALINA 320, 2000. Berkeley. \$64,000. Dodger, new mainsail, roller furling jib, good condition; well maintained within the OCSC fleet. (209) 872-0331 or moody_robert@hotmail.com.



35-FT HUNTER LEGEND, 1990. Marina Bay, Richmond. \$40,000. Pacific Cup veteran, full batten main, roller furling jib, Yanmar diesel, wind, depth, speed instruments, ST winches, VHF/stereo, CNG stove, spinnaker gear, dodger, open transom, sleeps 6, many spares, and extra sails. Contact (510) 235-4005 or quixote9094@aol.com.

CATALINA 34 MK 1.5, 1994. Rio Vista. \$61,500. Walk thru transom/swim platform. New Harken furler. Fully integrated Raymarine navigation and instrumentation. New standing and running rigging in 2010. Bottom paint July 2013. New dinghy. Chart plotter, autopilot, VHF w/ AIS, radar. Contact (707) 760-8002 or royarnoldcameron@yahoo.com.



32-FT PEARSON 323 SLOOP, 1978. Berkeley. \$21,000. Berkeley berth, great Bay boat, new prop in 2012, sails in good condition, excellent maintenance records. (510) 282-3316 or (510) 868-0228 or mikecdolan@gmail.com.

35-FT ALBERG, 1962. Richmond, CA. \$32,500. Full-keel sloop, pocket cruiser. New rigging, new lifelines, liferaft, Vari-Prop, electric windlass. Great condition, loads of extra equipment. (707) 485-5218.

32-FT WESTSAIL, 1975. Pillar Point Harbor, Half Moon Bay. \$-Best offer. Launched in 1980. Original owner. 3 headsails, one drifter, Perkins 4-108, propane stove with oven. Recent haulout, June 2013. Come see, make an offer. (650) 303-3901 or (650) 712-1425 or pgclausen@gmail.com.



33-FT NEWPORT 326, 1995. Channel Islands Harbor. \$32,000. Aft cabin port, galley starboard. two-burner stove, two-sided sink and c-c-c-cold fridge. Hot water, pressure water. 35 gal fresh, 10 gal holding, 35 gal diesel. 30hp Yanmar approx 500hrs. 33# Bruce in bow locker on 250' chain and three strand rode no windlass. Danforth stored aft. Inflatable with 3hp OB. 110 and 150 genoa on roller furling with two-speed Lewmar sheet winches. Main with two reef points with lines led inside full dodger. Cockpit seats in the rails at the aft corners, wheel steering and Raymarine radar at helm. Teak and holly belowdecks, topsides plastic/SS. CG Documented vessel. (805) 440-7947 or amicitia326@gmail.com.



35-FT CHRIS CRAFT SAIL YACHT, 1964. Ventura, CA. \$35,000. Prettiest boat in the anchorage. S&S design. Central America, Caribbean, East Coast vet. Windvane, canvas enclosure, bulletproof fiberglass hull, center cockpit. Hydraulic steering, hydraulic autopilot, Isuzu diesel. SSB. Inverter. Chains, anchors, sails. Varnished mahogany cabin top, new deck paint, just serviced seacocks. New bottom paint, new engine mounts. New cutlass bearing, new driplless shaft. (805) 637-1176 or markbmatthews@yahoo.com.



33-FT INTERNATIONAL ONE DESIGN. 1979. Tiburon, CA. \$28,000. Actively racing fiberglass IOD with recent sails. Good condition. Past owners include the infamous George Degnan. More at <http://sfiod.org/boats/9>. Contact (415) 306-6565, (415) 250-7854 or rspent@aol.com.

35-FT C&C LANDFALL, 1982. Tiburon. \$20,000. Recent engine work, new transmission, newer rod rigging, upholstery. Harken furler, B&G instruments, 2-speed self-tailing winches. Great Bay boat! Price reduced. Contact (707) 291-7867 or markvoss@sonic.net.



33-FT RANGER SHORT MAST, 1976. Treasure Island. \$23,900. Clean, well maintained, 450 hrs on 25hp Universal, 2009 Harken roller and Hood 100% genoa, new spinnaker pole, solar panel, May 2013 bottom, transferrable slip, moving, must sell. Contact (650) 224-4642 or 2chenette@gmail.com.

32-FT SAMSON C-MIST. \$4,000/obo. Professionally plastered and cured. Westsail cutter rig. aluminum, stainless, 6 Dacrons. Needs new cockpit and major overhaul. Lively to windward at 5 knots. Gordon Strassenburgh, 275 N. Broadway, #304, Coos Bay, OR, 97420.



32-FT ALLIED SEAWIND II. Cutter rig, 1979. Alameda. \$32,000. Excellent condition, 2010 diesel with 110 hrs. 2013 standing/running rigging and Schaefer furler. New Anderson winches. Forced air propane heat. VHF, autopilot. Fresh varnish. You will not be disappointed. (209) 200-7745 or ractundra@aol.com.

36 TO 39 FEET



36-FT CRUISING CUTTER, 1978. Newport Beach, CA. \$29,500. A no compromise cruising boat, designed for a couple to cruise. Fiberglass. VERY solidly built. Long cruising keel, with cutaway forefoot. Large, warm wooden interior - large tankage, large locker space and much in the way of storage. Center cockpit, cutter-rigged. A cozy aft cabin, with much storage, and a comfortable, athwartship double bunk. Main cabin has an L-shaped galley, large settee area (convertible for sleeping), much storage, full head, and separate shower. A solid, roomy, cozy boat - perfect for living aboard, extended weekends, or long distance liveaboard/cruising. Contact (949) 500-3440 or nb92663@hotmail.com.



37-FT PEARSON 365 SLOOP/CUTTER. 1978. Sausalito. \$49,500. 36.5-ft Pearson 365. Well maintained, upgraded, sailed, and lived on for 22+ yrs. Recent LPU topsides, Mainsail, much more... (415) 297-4080 or art_epstein@yahoo.com.

38-FT CATALINA 380, 1998. Alameda. \$114,900. Clean, well maintained. New lifelines, New standing and running rigging, new lazy jacks. Canvas new in 2011. Call (916) 296-7481.



MOBILE MARINE PUMP-OUT SERVICE

\$25 per pump up to 40 gallons.

Includes fresh water flush and a packet of treatment. 20% discount for regularly scheduled service.

www.mobilepumpout.com • (415) 465-0149 • tim@mobilepumpout.com

YOGA FOR SAILORS ON THE SAN RAFAEL WATERFRONT

Bow Yoga

Perfect for beginners and those seeking to balance strenuous activity with gentle stretching, rest and recovery. Small group classes Tues/Thurs and private sessions. (415) 785-4530, www.bowyoga.com.

DAVE'S DIVING SERVICE

Hull Cleaning • Zinc Replacement • Inspections • Props Replaced
New 75'x30' service dock in Sausalito also offers vessel wash and wax.

Crane services available. Fully insured and marina recommended.

(415) 331-3612 • Serving Southern Marin Since 1984

Certified Marine Surveyors

NAMS CMS - SAMS SA

Professional Marine Surveys • Serving the Delta
captainterrylee@gmail.com • (916) 599-5241



36-FT NH MARINER, 1979. Berkeley Marina. \$47,500. Upgraded for cruising, well maintained. New running and standing rigging, LED lighting, new AC and batteries, many more improvements. Yanmar 30hp. Beautiful interior and brightwork. More at <http://flic.kr/s/aHsjJa1bek>. Contact (510) 610-1791 or (510) 610-0435 or sweetpea-latitude38@tentacle.net.

36-FT ISLANDER FREEPORT "B", 1978. Loch Lomond, San Rafael. \$60,000. New full batten main, new dodger and sail cover, Espar heater, Isotherm refrigeration, Lectrasan, roller furling jib. Staysail, Blue Seas electrical panel, 2000W inverter. (510) 410-5401 or tgrady7889@msn.com.



37-FT CABO RICO, 1995. Vallejo. \$124,000. Crealock designed cutter well maintained. Two-time Mexico vet, Yanmar 2200hrs, new rigging. 2008 RIB tender 6hp 4-cyl. Nicely equipped Ha-Ha ready. Consider shared equity. (707) 477-6980 or jack@hewatt.net.

39-FT CAL, LONG BEACH, CA. \$49,000. Excellent condition, new roller furl, 24-mile radar, inverter, AM/FM stereo/CD, new VHF radio/GPS, chartplotter/GPS, LP gas stove/oven, dodger/bimini, new bottom paint '11, LP mast, head, water heater, hot and cold shower, refrigeration, 50hp diesel, autopilot, full wind/speed instruments. New hydraulic backstay, large solar panel, lazy jacks, 8-1 engine hoist, new golf cart and starting batteries, 2 anchors and chain/rode, great sail inventory. All standing rigging replaced in last 4 years. (562) 607-7310.

39-FT FREYA, 1978. Berkeley Marina. \$70,000. Very clean, ready for cruising. Professionally built and maintained, beautiful. Custom light interior, maple sole, ash bulkheads, rigged for singlehanding, loaded with equipment. Don't miss this opportunity to own a legend. Contact (510) 917-5229 or dalydolphins@aol.com.

37-FT CREALOCK, 1979. Monterey. \$59,000. Cruising consultants, new LPU entire boat, new interior, new Yanmar. Email for pics and video. www.crealock37forsale.com. (831) 234-4892 or dcd987@gmail.com.



38-FT CATALINA 380, 2000. Marina Village. \$117,500. Well maintained in beautiful condition. Recent survey. Deep keel, tall rig, all electronics, microwave, inverter, new batteries '12, new bottom '11, Westerbeke 40hp, 515 hrs, prof. serviced, beautiful interior, 6'9" headroom, queen aft cabin. See more at <http://catalina380bonnevièdeux.shutterfly.com>. Contact billsails2@yahoo.com or (408) 828-0837.

36-FT BENETEAU OCEANIS 361, 2001. La Paz, Mexico. \$79,500. One owner, great condition, well equipped. 2012 survey \$95,900. Located La Paz for convenient cruising in the Sea of Cortez and beyond. Picture and details at website or contact owner via email. More information at <http://lapazyachts.com> or email lapazsailboat@gmail.com.



38-FT AERODYNE, 2003. Tiburon. \$165,000. Ultimate performance cruising boat. Leisure Furl, electric halyard winch, seven Anderson SS winches, radar, TV/DVD, dodger, BBQ, retractable sprit, two spinnakers, Yanmar, SSB, Pactor, diesel heat, watermaker, new Awlgrip, windlass, liferaft. Ready for Mexico. (415) 385-3600 or hspotter@aol.com.



36-FT ISLANDER FREEPORT 36B, 1978. Alameda, CA. \$57,000 or trade for trade. Raised saloon, new engine. B plan. Has been completely new started. New board chainplates. Perkins 4108 was completely gone through, too much to list.



36-FT CATALINA, 2000. Berkeley Marina. \$87,500. Comfortable SF Bay cruising boat suitable for overnight sails and extended trips. This boat is part of a charter fleet and though it is used often, it is meticulously maintained and cared for. New mainsail in July and new jib in 2012. This boat has GPS, radar, autopilot, dodger and most other features standard to the Catalina 36 provisioning. (916) 947-6174 or dbosley@pacbell.net.

39-FT FREYA IN STEEL, 1974. Oxnard, CA. \$35,000/obo. Freya Halvorsen 39 steel sloop. Insulated, rebuilt 85hp Ford diesel. Autopilot, radar, GPS, fridge, shower, hot water. Hood roller furling, hydraulic windlass, sounder, dodger, refurbished aluminum mast/boom. Will trade. See <http://traim69@hotmail.com> or (805) 200-6089.



36-FT SCHUMACHER, 1989. Paradise Cay. \$39,900. *National Biscuit*. Located in Paradise Cay. Ready for racing! Carbon spinnaker pole, over 15 bags of sails, new running rigging, Yanmar 3-cylinder engine, triple spreader fractional rig. Contact: (415) 271-2722.

40 TO 50 FEET



40-FT J/120, 2001. San Francisco. \$149,000. Very clean and well maintained 2001 J/120. Extensive Quantum race sail inventory, lightly used, full B&G instrumentation including GPS interface, Yanmar diesel, plus much more... Contact (650) 363-1390 or (650) 722-2389 or richferrari@yahoo.com.



44-FT CATALINA MORGAN, 2007. Seattle, WA area. \$269,950. Mint condition. A real deck salon. Great bluewater cruiser. 75hp Yanmar 8+ cruising, 600 hours. New batteries, new solar, cruising spinnaker, power winches, hydronic heat, Raymarine C120, radar, autopilot, bow thruster. Trades acceptable. (408) 666-3261 or jerryfaia@aol.com.



40-FT BRUCE ROBERTS. Cutter rigged sloop, 1984. Bradford Island, CA. \$27,000/obo, land trade. *Windy*: Documented, 37-ft LOD, bluewater, custom built, classic design. Hull is 1-1/8" fiberglass, laid with Seaflex matting with integrated reinforcing fiberglass rods. Heavy-duty windlass, 4 anchors including 45lb CQR. Flush deck, hard dodger, 36hp diesel. Very sea kindly; proven Mexico cruiser. Comfortably built solid wood interior/mahogany, teak, maple. Bosch on-demand hot water heater, queen bed. "Little ship". Brad. (209) 406-0965 or (209) 855-4085 or bnrdeltadreamer@aol.com.



44-FT HUNTER 44DS, 2008. Kona Kai Marina, San Diego. \$199,000. Gorgeous! Loaded! 555 watts solar, 60-gallon/hour watermaker, 60 lb. Ultra anchor, 300' 5/16 chain, custom stainless rails/davits, custom 8" HMC mattress. Immaculate! Pics/info: <http://roadslesstraveled.us/hunter-44ds-groovy-for-sale> or emilyfagan1@gmail.com.



41-FT HANS CHRISTIAN, 1987. Oahu, Hawaii. \$165,000. Hans Christian Molokai version currently cruising the Hawaiian Islands. Perfect location to start your South Seas adventure. Many recent upgrades including new Garmin GPS, dinghy, outboard, roller furling, wind generator, water heater, head, running rigging, and updated autopilot. High-volume watermaker with spares. Rig recently tuned and inspected by professional rigger. Teak decks replaced in 2009 using epoxy with no screws! Dry boat in exceptional cruise-ready condition. For additional information call: (252) 622-1292 or robertmhal@yahoo.com.



40-FT HUNTER, 1990. Emeryville Marina. \$70,000. Hunter Legend. Boat is very spacious with centerline queen aft stateroom with plenty of storage, 2 heads, large galley, forward-facing navigation station, dinette seating and a large forward cabin. Great performance under sail and functions well both as a fast cruiser and a capable PHRF racer. Well equipped with good electronics, strong Yanmar engine, upgraded mainsail, new rigging, and detailed inside and out. Beautiful boat great for Bay sailing, very comfortable. (702) 303-4228 or fawcett1204@hotmail.com.



40-FT J/40, 1986. Flathead Lake, Montana. \$95,000. 43hp Volvo turbo 1100 hours, new Quantum roller furling headsail. Have road-ready three-axle trailer, sold separately for inland sailor's dry storage. Pictures, equipment list available. (406) 253-5566 or j22racer@hotmail.com.



42-FT ISLAND PACKET 420, 2000. San Diego. \$329,000. A no-kidding yacht with stowage and tankage for extended cruising or liveaboard comfort. Excellent offshore performance with this boat loaded and maintained to head to Tahiti tomorrow. Winches, windlass, autopilot, and engine all refurbished to as-new condition. Newer sails and ground tackle. New radar/chart plotter. Solar, 3kw gen, SSB, fresh-water flush in both heads. Dodger, bimini, full cockpit enclosure, foredeck awning. Contact (619) 403-7241 or mike.kat@cox.net.



40-FT CAL SHAMAN, 1966. Alameda, CA. \$98,000. Best equipped Cal 40 on the West Coast. Fully equipped for racing to Hawaii, coastal races, around the buoys, fully crewed or shorthanded, as well as cruising on the weekends with the family. Huge 3DL sail inventory, many upgrades including rig, instruments, autopilot, watermaker... Easomized. Must be seen. Complete specs on blog: www.sailblogs.com/member/cal40shaman. Contact (415) 725-9581 or swaterloo@gmail.com.

40-FT C&C AFT CABIN, 1983. Marin. \$60,900. Rare aft cabin 40 model. All standing rigging, instruments, roller furling, hydraulic backstay, and many other improvements less than five years old. Absolutely the most boat for the money. (415) 516-1299 or cc40sailboat@aol.com.

42-FT CATALINA, 1990. South Beach Harbor, San Francisco. \$89,900. Great condition. Extensive upgrades. Full spec at: <http://luluya.blogspot.com>. (650) 716-4548 or luluya123@gmail.com.



46-FT KELLY PETERSON, 1982. Morro Bay, Ca. \$159,000. Stretch/upgraded version of the Peterson 44. Built to highest standards by Jack Kelly Yachts. Teak interior. Fully enclosed cockpit w/fiberglass dodger. Fiberglass decks. Solar panels, wind generator, genset, watermaker, separate freezer, 2 autopilots, Raymarine electronics, heavy ground tackle, ample SS tankage, furling jib and staysail, electric main, gennaker. Custom deck box for SCUBA compressor and gear. Cruise-ready. Latest survey put replacement cost at \$545k. (408) 710-0693 or (805) 459-1909 or eddiekamp@sbcglobal.net.



45-FT GARDEN YAWL. One-off double ender, 3 years in restoration, 98% completed, cold-molded over original strip planking. \$30K as is, or \$? to finish renovation. Contact (916) 847-9064 or steve@paradigmpilgrim.com.



IRWIN 46 MK III SLOOP, 1988. South Beach Harbor, SF. \$79,500. Rare deep draft (6'-6") fin keel. Low engine hours, never raced. Priced for quick sale. Check irwinyachts.com for specs. Contact (408) 505-9328 or (951) 244-1116 or tenrightca2544@yahoo.com.



48-FT MAYFLOWER KETCH, 1985. Puerto Vallarta, Mexico. \$139,500USD. Sleek and graceful bluewater cruiser properly equipped can fly up to five sails with a crew of two. Designed by third-generation naval architect George Stadel III, the *Oriana* has proven performance, good construction, and detailed appointments. The deck, hull, and spars were repainted in 2013. With its ample captain's cabin, attractive, roomy salon, and fully-equipped galley, the boat is a comfortable liveaboard in any of the world's ports. Powered by the proven Perkins 92M, the craft cruises comfortably at 7.5 knots. Equipment includes roller furling on all masts, self-tailing winches, 300 ft. chain anchor rode, three sturdy anchors, watermaker, and more. See <http://TheOriana.com>. (480) 447-7316 or info@theoriana.com.



44-FT TARTAN 4400, 2003. Channel Island Harbor. \$379,000, or trade?. Reduced price! Dark green hull, low hours, bow thruster, electric winches, VacuFlush heads, spinnaker, new batteries, new LP and bottom paint, numerous other options/upgrades. See test sail at: www.youtube.com/watch?v=cKzHXEAMec. Contact amjohn@sbcglobal.net or (530) 318-0730.

47-FT CATALINA, \$264,500. Customized bluewater-ready. Extra fuel capacity, 110 or 240v, watermaker, chartplotter, radar, AIS, coldplate refridge/freezer. Custom cabinets and workshop, dive compressor, in-boom furler, staysail, autopilot, wind vane, new hard dodger, heat-air, Auto-prop. Much more. See <http://adream2sail.publishpath.com>. Call (916) 607-9026.



46-FT FARR, 1985. Seattle. \$199,000. Original owner, fast cruiser, frac rig, midship cockpit, Perkins 4-108, fully equipped for coastal and offshore - including radar, AIS, SSB, inverter, watermaker. For photos and specs, see website: <http://beachpartyfarr46.com>. Contact jsprouse01@gmail.com or (360) 471-4540.



40-FT SWIFT CENTER COCKPIT. Fiberglass ketch, 1978. San Francisco. \$76,000. Sparkman & Stephens design, hull No. 1, Lloyds-certified construction. Pisces Marine (Isuzu 3AB1) 3-cyl 40hp diesel. Substantial deck hardware upgrades and improvements. Strong, stable, sea kindly. Berthed Pier 39 Marina. Email challengesea@yahoo.com.



45-FT FASTNET 45, 1974. Portland. \$75,000. Beautiful boat, many compliments on her lines. Recently sailed to Australia and back. Very seaworthy, comes with a lot of equipment. Considerable locker space and storage for extended cruising. (503) 327-6750 or lighthead45@yahoo.com.



43-FT SERENDIPITY, 1981. Jack London Square. \$89,000. Doug Peterson design 43 customized for serious offshore racing/cruising, comfortable yet it can regularly sail 10+knots. Recent remodels and this Serendipity 43 is one of a kind; see website: <http://gosailsf.com>. (510) 926-7245 or hookedssailing@gmail.com.



40-FT KAURI WARWICK. (One-off), 1983. Whangarei, New Zealand. \$200,000. Kiwi-built triple-skin cold-molded kauri cutter. Details, go to house website: www.americankiwihome.com. Email neptune@ecentral.com. 150A Beach Road, Onerahi-Whangarei, 0110 New Zealand.



42-FT CASCADE, 1972. Redwood City. \$40,000. New sails, watermaker, Auto-helm, new rigging, ice maker, marinized Westerbeke and more. Needs work on deck. Spent a lot, asking for less. (650) 704-2302 or galaxaura@gmail.com.

47-FT SAMSON KETCH. Costa Mesa. Nearly completed, bluewater Samson ketch, Costa Mesa. Insulated ferrocement, full keel, center cockpit, full mahogany interior, 3 staterooms, 2 heads, 2 helms, 80hp Ford Lehman, 7 sails. Contact Rod for video/inventory list. (714) 963-9282.



47-FT 473 BENETEAU, 2006. Marina Village, Alameda, CA. \$240,000. Cruise ready. White hull. Deep keel. Teak decks, 3 cabin. 75hp Yanmar, 7.9 Westerbeke generator, Spectra Newport watermaker, air conditioning, custom upholstery, Cherry wood interior, bow thruster. Much more. (530) 545-9540 or jmbtahoe@yahoo.com.



47-FT VAGABOND, 1982. Brisbane, CA. Entertaining pre-listing offers. *SV Natural High* is for sale. 1982/95/99 Vagabond 47, 56' LOA. Too many details to list, see website for more details and photos: <http://svnaturalhigh.com>. Or email info@svnaturalhigh.com.





THE RAMP

AVAILABLE FOR PARTIES TOO!

BAR OPEN DAILY TILL 9 PM

LIVE LATIN MUSIC

Saturday & Sunday 5:30-8:30 pm
with an outdoor BBQ 5-8 pm

FRIDAY SUNSET SOIREEs

Dancing 6-9 pm

WEEKENDS

Brunch Served 9:30 am-4:30 pm

WEEKDAYS

Lunch Served M-F 11 am-4 pm
Happy Hour M-Th 4:30-7 pm

SAN FRANCISCO

(415) 621-2378

855 Terry François St., San Francisco
www.theramprestaurant.com

Like The Ramp on Facebook www.facebook.com/TheRampSF

NEW AND USED SAILS!

Specializing in production boats and featuring the largest selection of stock sails available anywhere! Save with warehouse volume discounts on Stock Sails, Custom Sails, Sail Covers, Furlers and Accessories. All top Quality.

FAST SHIPPING!

All Fully Guaranteed!

- Full Batten Mains
- Furling Genoa's
- Storm Jibs
- Trysails
- Furling Units
- Custom Canvas
- Used Sails

THE SAIL WAREHOUSE

Ph. (831) 646-5346 www.thesailwarehouse.com



Start Line Strategies

Winning Legal Strategies For Yachting

12+ years America's Cup Experience

Sponsor & Venue Arrangements • Crew Contracts
Vessel Shipping Logistics • Charter Agreements

Ashley Tobin

(925) 324-3686 • amtobin2@gmail.com

SS Marine

Full Service Boatyard

FREE HAULOUT
with paint and bottom job

For haulouts scheduled before October 30, 2013.

- Sail and Power up to 50'
- Mechanical
- Fiberglass Repair
- Bottom Paint
- Haulout
- Equipment and Rigging

145 Third St., San Rafael, CA 94901 • (415) 939-7353



46-FT COLIN PHILP CUTTER, 1987. Alameda \$105,000. Beautiful 46-ft round bilge steel cutter. Hawaii and British Columbia veteran. Completely ready for serious cruising, refit 2012. New rig, engine, steering system and electronics. Comfortable and seaworthy. Exceptional boat. U.S. Documentation. Contact sjr90@comcast.net or (415) 999-2270.



70-FT HOLLAND MARINE OFFSHORE. 1989. Portland, Oregon. \$275,000/obo. Proven heavily built 90-ton steel pilothouse sailboat built in Alameda, CA as U.S.C.G. inspected vessel. The Baja bash is a cakewalk with this little ship! www.svironmaiden.com. Contact (858) 212-5762 or captbillusmm@gmail.com.

41-FT MORGAN OUT ISLAND, 1972. Marina del Rey. \$54,000/obo. Sloop/cutter, center cockpit refurbished. 50hp Yanmar diesel (100 hours), radar, Icom 710, watermaker, 5 sails. For pictures, see website: www.yachtsoffered.com, go to listing 1291754. Contact (661) 548-6603, (661) 388-7670 or hwholthuis@juno.com.



65-FT PILOT HOUSE KETCH, 1975. Grenada, West Indies. \$75,000. Cold molded kauri, built New Zealand. Great liveaboard, tub, W/D. Easy singlehand. Cookware, tools, parts. Low hours on gen, main. Pics at: <http://woburnmarine.com/magic>. Call or email for details. (415) 233-1940 or gondolaman2@yahoo.com.

51 FEET & OVER



68-FT DERECKTOR, 1971. Richmond, CA. \$299,000. Fantastic Deerfoot-like expedition yacht set up for singlehanding or chartering. 2011 refit including new Yanmar, mast, sails, refrigeration, electronics. Just returned from voyage across Pacific to Fiji. More at www.sites.google.com/site/yachtpandion/home. (415) 663-8776 or svpandion@gmail.com.

CLASSIC BOATS



27-FT CUSTOM BILL GARVIE, EMILY. 1973. Everett, WA. \$39,000. Double-ended cutter. LOA 34-ft. Designed, built, owned (25 years) by Bill Garvie, San Rafael, CA. Mahogany on oak, bronze-fastened, teak decks, spruce spars, lead keel, diesel. South Pacific vet. Lovely, comfortable, sea kindly. (360) 568-2978 or svemily8@hotmail.com.



58-FT STEEL PILOTHOUSE. Expedition sailing ketch, 1999. Malaysia. \$750,000. Steel World Cruiser, fully hydraulic. Includes lifting keel and rudder, bow thruster, windlass, winches, new sails. Quality boat. Cash or trade for quality real estate. More at <http://apolloduck.net/279408>. (+60) 112-686-6453 or (+60) 14-672-5741 or brentmobile@yahoo.com.



YOGA GYPSIES

Yoga Gypsies are going to Belize! Join us on our exclusive sailing catamaran for a week of fun, yoga, exploration and sailing along one of the most beautiful coasts in the world. \$1,495 per person excluding airfare. Contact: Barry@yoga-gypsies.com • Dawn@yoga-gypsies.com • www.yoga-gypsies.com

Latitude 38 eBooks

FREE ★ AVAILABLE WORLDWIDE ★

www.latitude38.com/ebooks.html



58-FT STAYSAIL SCHOONER, 1925. Port Townsend, WA. \$159,000. *Suva*, 1925 staysail schooner designed by Ted Geary. A gorgeous and sound classic yacht that sails wonderfully! Teak. Financing available. www.schoonersforusa.com. (360) 643-3840 or schoonersforusa@gmail.com.



24-FT HIRONDELLE, 1970. Shoreline, WA. \$19,000. Price reduced! Trailerable cruising catamaran. Major refit 2003-6. Featured in issue #57 *Small Craft Advisor* magazine. See photos and info at [#1291883](http://YachtsOffered.com) and www.hironelle-association.org. (206) 999-5034 or genebuchholz@gmail.com.



23-FT L-7, 2010. Dana Point, CA. \$32,500. *Neutrino* is a custom built L-7 trimaran: very light and fast and "folds" (slides) in minutes to become an easily trailerable boat. Very well built, and looks and sails great. First launched 2011. Has electrical system, navigation lights, Suzuki 6hp outboard with alternator, anchors, etc. Sails are from Elliot-Pattison. New: main, jib (Dacron) and roller furling maxi-reacher made of Code Zero laminate on a bow pole. Contact (949) 922-1067 or acjdds@gmail.com.



34-FT CHB TRAWLER, 1976. Portland, Oregon. \$41,000. Beautiful, all fiberglass cruiser, loaded, all the comforts and necessities, 6-cyl, 1-1/2 gal/hr. Runs, looks excellent. Possible trade for heavy equipment. Contact (503) 260-6872 or genelivingston@peoplepc.com.

32-FT RHODES CHESAPEAKE, 1960. CYM Cabrillo San Pedro, CA. \$26,500/obo. World class sailboat, *Oly Rose*. Hull is F/G. Recent restoration: power, fuel tank, brightwork, deck, sail covers, dodger, all metal rebed, new wiring and electronics (Garmin 740s, New Horizons VHF w/AIS), new rigging, mast inspected and upgraded, new lines, new Simrad Tillerpilot; sailed down from Olympia, WA 9/2012. 2012 survey and documented vessel lying San Pedro. Listed with Shoreline Yacht Group in San Pedro or contact owner. Ready to go again!! Vessel can also be seen on website: www.rhodes32.com/Owners.html. (360) 481-1219 or newtmills@gmail.com.



38-FT CHAMBERLIN CAT, 1992. Nevis St Kitts, Caribbean. \$85,000. Custom composite Vac-bagged Divinycell/Vinylester/Biax racer/cruiser. 2 doubles, 1 head, galley up, bridgedeck with seated headroom (4'6", 5'9" in hulls). Queensland-built, 20,000 ocean miles. Must sell. Email sydeva@gmail.com.

37-FT SEARUNNER TRI, 1973. Eureka, CA. \$28,000. New roller furling jib, stay-sail, full batten main. GPS and 2 depth finders, new electric windlass. Yanmar 30hp, new propane SS stove. Recent bottom paint. (707) 498-4261.



40-FT RIVERQUEEN MK II, 1973. Pillar Point Harbor, El Granada, CA. \$39,888. Renovated to A-1 condition, ready to move in, 3-burner LP gas stove/oven, central heat and A/C, hot water heater, onboard shower, single engine 115hp outboard, steel hull, Sea Star hydraulic steering system, unrestricted liveboard privileges, Comcast, water and power hookups. It's like having a condo-in-the-water. (415) 308-6659 or (650) 570-5444 or peter@com-strat.com.

MULTIHULLS



38-FT FOUNTAINE PAJOT ATHENA. 1995. San Francisco, CA. \$164,000/obo. Our beloved ocean cruising vet *Family Circus* is for sale. New LPU in the salon, new canvas, new trampoline, dual Yanmars, one just rebuilt. Four cabins, two heads. Radar, GPS, plotter, etc. Ocean gear - drogue, liferaft, autopilot, spares, etc. Fantastic sailing platform for Bay and Ocean fun. Ready to go! Our family keeps growing- the boat needs to as well!! More at <http://htzortzis.wix.com/family-circus>. Contact ctzortzis2014@gmail.com or (925) 878-9659.



41-FT LAGOON 410 S2. Owner's version, 2004. San Diego. \$314,999. Well equipped cruising cat in great condition. Just back from a year in Mexico, and ready to go again, or use in So-Cal as a comfortable weekender. Solar, watermaker, extra ground tackle, etc. Still in time for the Ha-Ha! More at http://lagoon410s-2forsale.blogspot.com/2013_08_01_archive.html. Contact (619) 405-9349 or (619) 405-9961 or h.33.sdycc@gmail.com.



56-FT KETCH-RIGGED. Large motor-sailer catamaran, Vallejo, CA. \$15,000/as-is. *Baja*. Previously listed at \$30,000; now reduced to \$15,000, as-is. Two Ford Lehman 80hp diesel engines (under 300 hours), two Mercedes-Benz diesel generators (12; 18 KVA). Sails: main, mizzen, two furling jibs, spinnaker. Living quarters 800 sq. ft. Owner built. Launched 1972. Great ocean/river cruising boat. Shallow draft -3 feet. Electrical system requires electrical knowledge. (707) 446-1682.



50-FT EX-US NAVY LIBERTY. Conversion, 1944. Monterey Marina, Monterey, CA. \$55,000/obo. Liveaboard trawler conversion. Double V-berth, head, and shower. Spacious lower helm/galley with inside ladder to fly bridge. Aft cabin/salon/bedroom. Dual Capilano hydraulic steering. Detroit 671 diesel with Morse controls. Electrasan MSD, 35-gallon holding. New 50 amp shore power panel. New main battery panel. Comfortable large 6' high cabins. Tastefully decorated. Walk-around deck. Email us for photos. Slip transfers with sale. (831) 373-6061 or johna@arnoldassoc.com.

34-FT GEMINI 105MC, 2005. Redwood City, CA. \$119,900. High performance racing boat, that is also amazingly a spacious liveaboard or mobile vacation condo. Perfect for watching the America's Cup in comfort and style. Fast; easy to sail singlehanded without heeling. Spacious deck, 3 bedroom interior, protected cockpit. Contact (650) 380-3343 or loon.asea@yahoo.com.



40-FT BROWN TRIMARAN. Rio Vista, CA. \$20,000/obo. Diesel, sails, rigging. (707) 489-2137 or (707) 459-2132.

POWER & HOUSEBOATS



28-FT CARVER MARINER, 1978. \$15,000/obo. Hot and cold water, refrigeration, new battery, single inboard, head-shower. Sleeps 6. Great liveaboard. (510) 581-4720.



CHAINPLATES EXPRESS

316 SS Chainplates to Fit all Sailboats

Next Day Service for Commercial Accounts • Electro-Polished FREE

Boat Shafts, Railings, Rigging and other Stainless Steel Fabrication Available

www.chainplatesexpress.com • (281) 559-2407 • rollformers@verizon.net

'lectronic Latitude

Just like the magazine but... online, three times a week, and totally different! Find it at www.latitude38.com/



PROFESSIONAL DELIVERY CAPTAINS

San Diego based, USCG Master 100 GT. Sail and power.

ASA-certified instructional deliveries. Pacific Mexico and Baja Bash specialists.

davidbrotherton@yahoo.com • www.boatedeliverycaptain.org

• (619) 913-7834 •

COMPLETE MARINE WOODWORK

Design / Restoration • Expert European Craftsmanship • Interior / Exterior

Repairs / Maintenance • Marine Windows & Frame Replacement

Wood & Dry Rot Repairs • Varnish Work • Marine Painting

Reasonable Rates • (415) 453-2231 • References Available



*A Sailor's
Consignment
Chandlery*

NEW & USED BOAT GEAR
Open Tues.-Sat. 10 to 5 p.m.

510-769-4858

Located at Grand Marina

www.bluepelicanmarine.com

HAWAII

LONG TERM DRY STORAGE

Clear Customs at our dock

GENTRY'S

KONA MARINA

HONOKOHAU HARBOR

156°1'30" W
19°40'20" N

TOLL FREE **888-458-7896**

www.gentryskonamarina.com

The friendliest boatyard in Hawaii



FULL SERVICE MOBILE RIGGING



Alameda

yachtcheck@yahoo.com

(510) 815-4420

- Competitive Rates
- More than 20 years experience
- Firm labor quotes on most projects

Mathiesen Marine

For all of your electronics and electrical needs

*Sales & Installation of all major brands
of marine electronics*



*Electrical system
Troubleshooting & Repair*



*PC & Mac based
Navigation Systems*

AUTHORIZED INSTALLER

Corrosion issues, Inverters, Battery Banks

Visit our showroom located at
3300 Powell Street, Emeryville

(510) 350-6622 www.MathiesenMarine.com



63-FT BERTRAM, 1971. Sausalito. \$179,000. 63-ft Bertram International Motor Yacht. Fiberglass hull. 2 salons. 3 staterooms. 2 heads. Jacuzzi tub in main stateroom, washer/dryer. Twin 500hp Cat diesels. Autopilot. 2 generators. 47" TV + 3 more. Comfortable living. (415) 331-6832 or els@well.com.

PARTNERSHIPS



30-FT WYLIECAT, 2004. Richmond YC. \$52,000. 50% equity interest (1/2 expenses), 100% fun. Hull 16, Yanmar, Raymarine instruments, new wishbone '08. Shorthander's dream. Well maintained and cared for. For more info email, wyliecatseller@yahoo.com.



NON-EQUITY PARTNER WANTED. For Pearson Triton 28. San Rafael. \$140/month. Seeking a qualified sailor with some basic maintenance skills for Triton 28 located in San Rafael. Ample sailing time available. \$500 security, \$140 month. <http://captainbradley.com>. Contact (415) 261-1004 or sailmba04@yahoo.com.

C&C 30 SAILBOAT SAUSALITO. Non-equity partnership. Boat in excellent condition, 15hp Yanmar inboard, furling jib, dodger, autopilot, GPS, fathometer, wind indicator, speedometer, VHF radio. Galley, head with shower, sleeps 4. \$600 security deposit, \$150/month dues. (415) 459-7417 or edcurran5@gmail.com.

CATALINA 30, 1974, 1/3 EQUITY. South Beach Harbor. \$4,500. Early Catalina 30, hull #42, tiller, jib furler, Atomic 4. 1/3 equity partnership. (650) 291-9013 or colin.n.murphy@gmail.com.

PARTNER(S) WANTED. I am interested in purchasing a late-model 40+ ft. sailboat for sailing in the Bay and on the coast. Looking for partner(s) with the same desire who might be interested in sharing ownership and costs. At this point, I'm open to the number of partners and the type of sailboat that would be purchased. The goal would be to purchase and maintain a sailboat that might normally be beyond the means of an individual owner. (510) 676-4913 or brjewell@sbcglobal.net.



1990 BENETEAU 38 WITH BERTH. In SF Marina West Basin, West Harbor. \$89,000/obo. Currently owned by 2 partners, one of whom wishes to sell. Full boat or half partnership optional. This boat is in beautiful condition and sailed the Baja Ha-Ha from SF to Cabo and La Paz in 2011 and 2012. Equipped with state-of-the-art electronics and 3-year-old Yanmar 33 engine. Too many features to list here. (209) 988-4884 or (510) 703-2484 or donker@well.com.

SOUTH OF THE BORDER

COSTALEGRE VACATION RENTALS. La Manzanilla. Bungalows, homes, condos, camping, beachfront, hillside, views. In charming La Manzanilla. Plan your winter getaway now. (415) 847-0570 or pistolera16@yahoo.com.



PLAN YOUR MEXICAN GETAWAY NOW. At the brand-new, gorgeous Cielo Y Mar condos. Located in Punta Mita, 35 minutes from Puerto Vallarta, available to rent from private owner. On the beach, 10 feet from the water, they offer spectacular views of ocean and mountains, the biggest infinity pool in the area, tremendous views of whales, bird life and the islands. While uncrowded and tranquil, just a five-minute walk to several waterfront restaurants. Choose from a spacious, beautifully furnished one- or three-bedroom unit, or an amazing two-story penthouse with lovely shade trellis on the top floor. See details at website: www.puntamitabeachfrontcondos.com. To reserve, call Dona de Mallorca, (415) 599-5012.

OFFSHORE PAGESHOPPING INSTRUCTION IN THE SOUTH PACIFIC

John & Amanda Neal are dedicated to providing hands-on, documented instruction aboard their Hallberg-Rassy 46 *Mahina Tiare III*, drawing on their combined 584,000 miles and 73 years of experience.

www.mahina.com • **(360) 378-6131**

Going Somewhere?

Mexico ≈ Caribbean ≈ South Pacific

Stop by our office and take a bundle of *Latitude 38* magazines along with you. We promise you'll be a hero for sharing them with other cruisers!

Latitude 38 • 15 Locust Ave • Mill Valley, CA • (415) 383-8200 • Open M-F 9-5

GEAR



MAIN AND MIZZEN BOOMS. With Harken Battcar. \$4,600 for both. Two booms, two Harken Battcar systems, main and mizzen sails, main boom vang, lazy jacks, main and mizzen covers. Both were made for Tatoosh 51 (Robert Perry design). They are aluminum, oyster white, with green sail covers and gooseneck and mast fitting. Main boom; \$2,700. Length: 19' 1", 4-3/4" wide and 7-5/8" high. 3 sheaves and 3 Spinlock clutches. Vang plate with 5/8" pin. Lazy jack system. Cunningham set. Harken B BattCar system. Hall Spars QuikVang with quick vang boom vang mast fitting. Approximately 90" long. Mizzen boom; \$1,900. Length: 13' 4-1/2", 4" wide and 5-7/8" high. 3 sheaves. Harken A BattCar system. (415) 860-0103 or sugano.norio@gmail.com.

VIKING LIFERAFT. Tiburon, CA. \$2,000. RescYou Pro automatic self righting 4-person liferaft in valise. ISO 9650-1 certified and ISAF approved. 71lbs. Purchased spring 2012, commissioned 5/2012, next service 5/2015. Offshore Type E equipment pack. Real insurance! Contact solstice100@gmail.com or (415) 408-8001.

CRUISING GEAR. Harbor Isle - San Diego. Available mid-October, MRUD for monitor, shroud cutters (manual and hydraulic), Hawkeye handheld digital sounder, 50' 30amp shore power, Garhauer kayak/sup racks, 20kg Bruce, sunshade cover, Winslow 6-person coastal liferaft, jacklines, Dutchman boom brake, fish gaffs, cruising guides, scuba tanks, Gamesaver food vac, parachute drogue, Forespar toggle spinnaker mast car. Email with questions or for complete list with prices. Email svsilik@icloud.com.

MONITOR VANE. Sausalito. \$3,950. Two standard airvane and one light airvane. Spare safety tube, wheel adapter, Cruising parts kit. Optional emergency rudder conversion kit. Mounts made for Peterson 34. More at <http://web.magewind.com/magewind>. Contact (415) 332-4810 or lat38@magewind.com.

74-FT MAST. Designed for catamaran Best offer. (415) 269-5165.

ALMOST NEW NISSAN 6 HP. Outboard motor. San Francisco. \$1,250/obo. Nissan 6hp four-stroke outboard motor (used less than six hours). 25 inch, extra long shaft, manual start and external gas tank. GREAT BUY. Contact (415) 751-5708 or davidhartsough@igc.org.

MONITOR WIND VANE. Pittsburg, CA. Best offer over \$2,500. 5 years old, but not used in last 3+ years. Stored off boat. (925) 360-9155 or secrebtree@att.net.



MAXWELL NILSSON WINDLASS. Costa Mesa, CA (Orange County). \$2,500. Brand new. Manual ratchet/pinion screw crank. Bronze chain gypsy and rope capstans for 45- to 55-ft boat. 5/8" chain. (714) 815-7245, 1672 Placentia Avenue, Costa Mesa, CA. Email mchan1023@gmail.com.

BOAT PARTS FOR SALE. Fernley, Nevada, will ship. OBO. Galerider, 42" storm drogue, new in bag; \$650. Bridle for drogue, new w/chafe gear; \$150. Rode for drogue, 250' 5/8", new triple strand w/ bag; \$325. Paratech 18' sea anchor, nib; \$800. New rode for sea anchor, 230' 3/4", triple strand; \$350. Additional new rode for sea anchor, 200' 3/4", triple strand; \$300. Used Espar Airtronic D3 diesel forced air heater, 12,000 BTU, 12v; \$800. Katadyn/PUR Survivor 35, RO desalinators, nib's \$1,200. 2 nib never deployed patten valise pack LRU 7-person liferafts, need air bottle(s); \$1,600 each. ACR 406 EPIRB \$400. Prices obo, request photos, will ship, credit cards and PayPal OK. Contact Kevin. (775) 835-2388 or slrman@live.com.

PROPERTY SALE/RENT



RICHMOND RIVIERA. 3 Bdrm/3 Ba home + 50' boat dock. Located at 1305 Sanderling Island, Brickyard Cove - just \$899,000. Protected deep water channel by Richmond Yacht Club. Side access to dock. Guest/in-law detached building. Sauna plus large protected deck areas. Short walk/drive to Historic Point Richmond. FMI Inc./Feagley Realtors. More at www.sanfranciscobayfronthomes.com. Contact (800) 310-5478 ext.108 or whatshisface@feagleyrealtors.com.



NO CAL DELTA - 70-FT DOCK. And 27-acre ranch. Rio Vista. \$575,000. Sherman Island. 70-ft newer dock in deep water and close to Sacramento River. Between Antioch and Rio Vista. Close to SF. 2 bedroom home with shops, etc. on 27 acres. www.californiaoutdoorproperties.com/viewlisting.php?returnstate=&searchstr=agentid%3D55&listingid=830. Contact curtis@caoutdoorproperties.com or (707) 761-3343.

PAVONES, COSTA RICA. Beachfront lot. Premier hotel site. 1 1/2 acres. Direct beachfront of world famous "Pavones surf break". All permits, ready to build NOW! Stunning property! Absolutely prime real estate. www.pavonesbeachfront.com. Call in Costa Rica: (011-506) 8834-4545 or pavonesbeachfront@gmail.com.



BAY AREA HIDEAWAY. Mill Valley, CA. Large 1 bedroom apartment, 2 short, flat blocks from downtown Mill Valley, and close to the Bay, beaches and hiking. This is an upper unit, 2 decks, one above a babbling creek, the other beneath the redwoods. Well equipped AEK with dishwasher, full bath, large bedroom with queen size bed. Covered parking, washer/dryer on premises. Hi-speed Wi-Fi, cable, DVD. \$120 a night, 2 night minimum. No smoking, no pets. More info at www.airbnb.com/rooms/160781 or email franicowan@yahoo.com.

BERTHS & SLIPS

PIER 39 SLIP FOR SALE. San Francisco. \$10,000. D-Dock, slip 1 (40x14) on the quiet side of the Pier - sheltered from the wind, away from the crowds and sea lions. 2 parking cars, showers, laundry. Contact Brian: ubhere@sbcglobal.net or (408) 234-1611.

OAKLAND YACHT CLUB. Alameda. If your boat is 30-ft or less, we have special discounts on our slips. Discover the fun, fellowship, and savings of belonging to a yacht club. Find out how by calling the Oakland Yacht Club, celebrating its 100th year in Alameda, CA. (510) 522-6868. More at www.oaklandyachtclub.net.

50-FT COMMERCIAL SLIP. San Francisco, Pier 39. \$55,000. Newly constructed J-Dock, Slip 6, west side with views of Golden Gate Bridge, Angel Island, and Alcatraz Island. Special rates for owners at Pier 39 parking garage. Sublease until 2034, contact James. (650) 520-4607 or jvandyke100@yahoo.com.

DOCK SPACE FOR YACHT UP TO 90-FT. Point Richmond. \$400/month. Safe, quiet, low-traffic dock for motor or sail yacht at private home. Locked gate with 24/7 access. \$400 per month PLUS power. No liveaboard. (510) 237-2020 or (510) 666-4257 or emalonai@tyriscorp.com.

WINTER END-TIE SUBLEASE. Marina Plaza, Sausalito. \$1000 mo (includes DSL) plus utilities. What a spot! Incredible views, lots of parking, walk to everything. 55 foot sublease available thru April, possible extension. First, last and deposit. (415) 480-9042.

SOUTH BEACH HARBOR SLIP. South Beach Harbor, SF. Walk to AT&T Park, restaurants, MUNI and America's Cup Pavilion. No wait list. Slip can accommodate up to 35-ft boat. For info contact John, johnharold@buslog.com or (831) 461-1180.

SLIP FOR SALE 36'. Pier 39, San Francisco. \$6,500. Best deal in San Francisco. 36' slip, all amenities, great location. (510) 525-7613.

50-FT PRIME SLIP, PIER 39, SF. \$50,000. F-Dock, Slip 11, east side. Protected from wind. Close to gangway, showers and marina office. Covered parking across street with special rates for owners. (559) 355-6572 or scorch@tempest-edge.com.

CREW

OFFSHORE INSTRUCTION. John and Amanda Neal provide documented ocean passagemaking instruction aboard *Mahina Tiare III*, their Hallberg-Rassy 46, drawing on their combined 584,000 miles and 73 years experience. More info at www.mahina.com or (360) 378-6131.



BAJA HA-HA. Sail aboard 48-ft performance catamaran *Sea Level*. Enjoy comfort and speed. Learn what we've learned in our six years of cruising including our circumnavigation. \$200 per person, per day, double occupancy. All meals included. Vegetarian no problem. Email jimmiiski@yahoo.com.

GREAT TRIP FREE. Need male/mate to help bring 53-ft Hatteras MY from Virginia to SD, 11/13 to 3/14? No wage, but free room/board. Not delivery type, but pleasure trip. Many stops. Navigation experience a plus. Send info to: barbann3@gmail.com.

SAIL RAISON D'ETRE. (Hallberg-Rassy 42E Ketch). Need a third crew member to sail from Canary Islands November 16 to BVI (in trade winds), then through Panama Canal. We believe having a pleasant personality and being a quick study are more important than rank experience. H-R 42E ketch sailing characteristics are pure sweetness. Setup for easy watches. All consumables shared. She has new sails, overhauled engine, life raft, runabout, sailed from Greece for shakedown. Email Lang@ExergeticSystems.com.

PERSONALS



1ST MATE WANTED. Alameda. Tall, warm-hearted, fun-loving, retired sailor with spotless 31-ft sailboat berthed in Alameda, seeks warm-hearted, upbeat, mellow, physically fit woman to share sailing his boat on San Francisco Bay. You don't have to be an expert sailor, just enjoy sailing. If you are available to sail during weekdays and would also enjoy occasional picnics on Angel Island, call me at: (510) 704-0772.





FOR SALE: BRISTOL 41.1

1981 center cockpit.
Ted Hood
centerboard design.
Fully outfitted,
maintained and
ready for extended
cruising.

\$130,000

Visit the comprehensive website:

<https://sites.google.com/site/gallivanter4sale>

mwilliford@gmail.com

BAY MARINE DIESEL

Marine Inboard Diesel Repair
Surveys • Personalized Instruction

Cummins | Ford/Lehman | Hino | Perkins
Universal | Westerbeke | Yanmar



Marty Chin, Owner – (510) 435-8870
Email: Baymarinediesel@comcast.net

CUSTOM TIDE CALENDARS

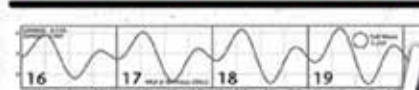

WITH YOUR PHOTOS,
TIDES, AND LOGO FROM
\$6.50 TO \$19.95 EACH

Enter Promo Code **LAT** At Checkout
And Enjoy **10% Off** Your Order!



(760) 753-1747
www.tidelines.com

California Professional Divers Association

Is your hull cleaner a member? If not, he should be

CPDA members are the only divers in California trained and certified in the use of state-recognized In-water Hull Cleaning Best Management Practices. These BMPs are designed to minimize the diver's impact on the environment and maximize your expensive anti fouling paint's lifespan and performance.

Visit our web site to find a conscientious, professional hull cleaner near you.

www.prodivers.org

(619) 600-0444 info@prodivers.org



JOBS WANTED

PART-TIME CAPTAIN. USCG Master 50 GT with tow, looking for interesting part-time work on the water in Bay Area. Retired successful businessman, mid-50s, with great people skills. Contact Michael Long, michael@longfinancial.net or (707) 483-0191.

JOB OPPORTUNITIES

SAILING JOURNALIST WANTED. Latitude 38 is seeking applicants for a position in our editorial department. This is an in-house position at our World Headquarters in verdant Mill Valley, CA. See the full job description and contact info at www.latitude38.com/jobs/jobs.html. ABSOLUTELY NO PHONE CALLS.

MARINE TECHNICIAN. Hirschfeld Yacht is a Bay Area leader in the sales, repair, service, installation, and customization of marine diesel engines and generators. We are looking for marine technicians to join our team. Minimum qualifications: 2+ years direct mechanical/electrical experience. Experience with gas and diesel engines ranging from 10-300hp, inboards and outboards. Experience with manufacturers such as Mercruiser, Mercury, Honda, Yamaha, Beta Marine, Yanmar, Perkins, Volvo, or Universal. Expertise in electrical systems with a solid understanding of electrical fundamentals. Clean background check. Must have a California driver's license and car/truck. Must have own tools and mobile tool kit/bag. Preferred qualifications: ABYC Certifications, manufacturer specific certifications, gas/diesel technology certifications, electrical certifications. For more information and to apply, email: hycbetawest@gmail.com.

WANTED - SAILING INSTRUCTORS. Redwood City. Spinnaker Sailing in Redwood City is looking for P/T sailing instructors. Must have a passion for sailing and people. Flexible schedules, competitive pay and a great group to work with. Call Rich or Bob or email. (650) 363-1390 or rich@spinnakersailing.com.

BUSINESS OPPORTUNITIES



LIVE THE DREAM. \$250,000. 30-year established charter business for sale. *Sadie Sea* operates out of St. John, U.S. Virgin Islands, and is certified to hold 31 passengers. Contract with National Park Service to pick up hikers and many other partnerships. New paint, survey, lower decks and stability test summer 2012. Email for more details. www.sadiesea.com or sadieeacharters@gmail.com.

ESTABLISHED MARINE RETAIL STORE. Southern Oregon. In business since 1996. Owner has several operating business and is retiring. Located in southern Oregon and priced for a quick sale. Possible owner financing to qualified buyer with substantial down payment. \$50K plus inventory. Call for details. (541) 661-9248.

SEASONAL RESTAURANT. For sale. Vancouver Island, BC, Canada. \$395,000CAD. Are you a hospitality professional AND a sailor? Work 5 to 6 summer months, cruise the rest of the year - as we have done for 12 years. Check our website: <http://49north.com>.

Latitude 38's BAJA HA-HA XX SEND-OFF PARADE

On San Diego Bay Monday, October 28
9:00-11:00 a.m.

You're invited to escort more than 150 sailboats out the bay for the cruise of a lifetime!



Celebrating the 20th annual Baja Ha-Ha rally

- 9:00-9:30: South Bay boats pass San Diego to Harbor Island.
- 9:45: All boats gather off America's Cup Harbor between Harbor Island and Shelter Island.
- 10:00: All boats parade past southwest corner of Shelter Island past the San Diego fireboat.
- 11:00: America's Cup starting gun begins Baja Ha-Ha XX.

Thanks to the San Diego Port Tenants Association
(619) 226-6546
www.sdpta.com



Sponsored by
Latitude 38
www.latitude38.com

Bilge Steam Cleaning Oil Changes

Professional service at your slip!!!



MarineLube 877 744-2244

www.MarineLube.biz



Fuel Polishing Tank Cleaning

HARD • FAST • CLEAN



The Environmental Paint Company

www.epaint.com

Bonita Marine Dist.
(209) 772-9695

Newport Coast Yachts
888-4-1-YACHT
www.newportcoastyachts.com

Local, National and International Sales
Trailers, Trucking and Shipping



Tari Soderling
949-295-9654



BENETEAU OCEANIS 510, '93 Four staterooms and four heads. High gloss walnut interior. All systems and paint upgraded. Beautiful and ready to go! Asking \$189,000



HERRESHOFF CARIBBEAN 50, 1978. Full keel ketch bluewater cruiser. Well equipped. Big aft cabin, new interior. Big diesel with 1,200 mile range. Asking \$122,000



PEARSON 323, 1977. Roomy cockpit and cabin. New standing rigging 2011. New bottom paint, thru hulls and boot stripe 2012. Four sails. Asking \$17,900



CONTROVERSY 31, 1956/2006. Glass over wood. Complete refit and hull rebuilt 2006. Survey on file. New cockpit cushions. All bronze fittings. Asking \$14,900



LBSF DONATION

CATALINA 22, 1985
Nice condition. Newer trailer, 4-stroke, and upholstery.
Asking \$4,000
Donate your boat to Long Beach Sailing Foundation.

FREE USCG LESSONS FOR ALL OF OUR NEW BOAT BUYERS!



ADVERTISERS' INDEX

AB Marine.....52	BottomSiders.....113	E Paint.....157	Helmu's Marine Service....56	Loch Lomond Marina.....47
Almar Marinas.....41	Breakwater Cove Marina.....61	Easom Rigging.....57	Heritage Marine Insurance.....66	Mack Sails.....64
American Battery.....145	Brisbane Marina.....67	Elco Electric Boats.....64	Heritage Yacht Sales.....160	Makela Boatworks.....140
Aqua Marine.....63	California Professional Divers Association.....156	Emery Cove Yacht Harbor.....45	Hirschfeld Yacht.....56	Marchal Sailmakers.....144
Bacon Sails & Marine Supplies.....47	City Yachts.....10-11	Emeryville Marina.....69	Hogin Sails.....18	Marina Bay Yacht Harbor.....25
BVI Yacht Charters.....129	Club Nautique.....50	Equipment Parts Sales.....145	Hood Sails.....15	Marina de La Paz.....140
Baja Ha-Ha Beach Party.....141	Conch Charters.....128	Essex Credit Corp.....40	Hotwire Enterprises.....140	Marina El Cid.....54
Baja Ha-Ha Sponsors.....105-107	Cover Craft.....101	Farallone Yacht Sales.....13	Hydrovane.....60	Marina Mazatlan.....39
Ballenger Spars.....91	Coyote Point Marina.....51	Farr 40 Class.....19	Interlux Yacht Finishes.....37	MarineLube.....157
Bay Marine Boatworks.....35	Cruising Yachts/Sail California.....8-9	Flying Cloud Yachts.....159	Iverson's Design.....55	Marine Outboard Company.....46
Bay Marine Diesel.....156	Defender Industries.....49	Fortman Marina.....91	JK3 Nautical Enterprises.....17	Mariner's General Insurance.....65
Berkeley Marine Center....49	DeWitt Studio.....116	Gentry's Kona Marina....154	KKMI - Brokerage.....161	Maritime Institute.....61
Blue Pelican.....154	Dinghy Doctor, The.....60	Gianola Canvas Products.....51	KKMI - Boatyard.....164	Marotta Yachts.....162
Blue Water Yacht Insurance.....68	Dolphin Marine and Yacht Sales.....158	Grand Marina.....2	Kissinger Canvas.....69	Mast Mate.....113
Boat Yard at Grand Marina, The.....21	Downwind Marine.....33	Hansen Rigging.....91	Larry R. Mayne Yacht & Ship Broker.....48	Mathiesen Marine.....154
BoatSmith Marine Carpentry and Boatbuilding.....129	Doyle Sails.....29	Harbor Island West Marina.....112	Lee Sails.....158	McDermott Costa Insurance.....101
	Dr. LED.....129	Harken.....36	Leukemia Cup.....123	McGinnis Insurance.....63
	e Marine Systems.....144	Helms Yacht & Ship Brokers.....159	List Marine Enterprises.....47	

CONTINUED ➤

QUALITY CRUISING SAILS FOR LESS!



**MAINSAILS
MIZZENS
STAYSAILS
HEADSAILS
SPINNAKERS
SAILCOVERS
STRONGTRACK**

leesailsca@yahoo.com

(707) 386-2490

SAILMAKER TO THE WORLD

**Mobile Marine Navigation
Installations and Marine
Electrical Work
POWER
& SAIL**

**VESSEL
ELECTRIC**

GARMIN
certified installer

Raymarine
certified installer

Milltech Marine AIS



Brian Theobald • (415) 424-2204 • vesselelectric@yahoo.com



**LONG
BEACH**



Transpac 49, 1976
\$195,000



Grady White 330, 2004
Express \$124,900



Mediterranean 38, 1996
Convertible \$119,500



Ocean 53, 1996
Power Cat \$219,000

JULIE SHELDON • (714) 296-8531
FISHNETS8989@HOTMAIL.COM
CALL OR EMAIL FOR AN APPOINTMENT.

ADVERTISERS' INDEX – cont'd

Meridian Yacht Sales 159	Oyster Cove Marina 63	Sail Warehouse, The 152	Strictly Sail Long Beach 27	West Marine - Rigging 44
Mermaid Sails the Bay 58	Pacific Crest Canvas 32	Sailrite Kits 22	Suncoast Yachts & Charters 54	Westwind Precision Details 31
Minney's Yacht Surplus 145	Pacific Offshore Rigging 55	Sal's Inflatable Services 49	Svendsen's Boat Works 23	Whale Point Marine Supply 20
Multihull Company, The .. 161	Pacific Rigging 154	San Francisco Boat Works 90	Svendsen's Marine 42	Wiest, Michael, Yacht Sales 45
Napa Valley Marina 59	Pacific Yacht Imports 28	Scanmar International 6	Swedish Marine 53	Yacht For Sale: Bristol 41 156
New England Ropes 117	Paradise Village 43	Schoonmaker Point Marina 34	TMM Yacht Charters 128	Yachtfinders/Windseakers 53
New Era Yachts 160	Passage Yachts 5	Sea Hawk/New Nautical Coatings 59	Tidelines 156	
Newport Coast Yachts 157	Pineapple Sails 3	Seashine 61	Trident Funding 4	
Nor'Sea Yachts/ Montgomery Boats 67	Punta Mita 142	Seatech 144	Twin Rivers Marine Insurance 53	
Norpac Yachts 163	Quantum Pacific 24	Sequoia Yacht Club 26	Ullman Sails - San Diego... 113	
North Beach Marine Canvas 31	Quickline 59	South Beach Harbor 30	Vallejo Marina 55	
North Direct Sails 62	Raiatea Carenage Services 145	South Beach Riggers 31	Ventura Harbor Boatyard 57	
North Sails 7	Ramp, The 152	Spaulding Wooden Boat Center 38	Vessel Electric 158	
Oakland Yacht Club 66	Reckoning At Sea: Eye To Eye With A Grey Whale 58	Spectra Watermakers 143	Volpar 69	
Opequimar Marine Center 65	Richardson Bay Marina 57	Starbuck Canvas 67	weatherguy.com 129	
Outboard Motor Shop 65	Rigging Loft 144	Start Line Strategies 152	Wedlock, Ramsay & Whiting Marine Surveyors 145	
Outland Hatch Covers 68	SS Marine: Yacht Sales and Boatyard 152	Stem to Stern 51	West Marine 12, 14, 16	
Owl Harbor Marina 100		Sterling Associates 62		





Flying Cloud Yachts



6400 Marina Drive
Long Beach, CA 90803

Sail • BROKERS • Power
www.flyingcloudyachts.net
flyingcloud@verizon.net

Phone (562) 594-9716
Fax (562) 594-0710



47' VALIANT/50, '02 \$539,500



45' HUNTER, '98 \$170,000



35' FUJI SLOOP, '76 \$35,000



33' BENETEAU, '01 \$82,000



34' GEMINI 105M, '97 \$89,000



37' JEANNEAU, '02 \$103,000



34' GEMINI 105M, '98



45' CREEKMORE, CC '81 \$59,000



43' TASWELL CUTTER, '89 \$175,000



36' CATALINAS, three from \$49,500



38' CATALINA, '82 \$30,000



34' DIANA, '83 \$35,000

APPROX. 100 LISTINGS ON OUR WEB SITE: www.flyingcloudyachts.net

VALIANT BROKERAGE!



VALIANT 50 *Raptor Dance*

This is a superb cruising yacht equipped to go anywhere. In excellent condition and set up for a couple to sail or for a singlehanded passage. There is nothing finer made in this class. Asking \$535,000



VALIANT 42 *Acacia*

A 2001 model equipped to the max. The Valiant 42 is the standard in the sailing world and this one is ready to go. Engine hours 589.

Asking \$284,000



VALIANT 40

Texas-built, loaded for cruising, and in great shape. Asking \$160,000



VALIANT 42 *Krystal Seas*

A 2001 that has not been sailed much, but is equipped to do so. The second owner did extended upgrades in 2005. Asking \$330,000

Call Dick May

MERIDIAN YACHT SALES

Grand Marina • Alameda

boatseller@aol.com

(510) 217-8497

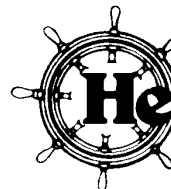

www.helmsyacht.com

Helms

YACHT SALES INC.

(510) 865-2511

(510) 435-3147

Dealer for Corsair • Seawind • Dragonfly



FOUNTAIN PAJOT 43
2003
\$349,000



PACIFIC SEACRAFT YAWL
Cruise ready to go to
Mexico. \$99,000



34' GEMINI 105MC
Catamaran
Two for sale.



NEW 2014 CORSAIR
750 Dash and Sprint
just arrived.

HERITAGE

Yacht Sales

Live your Dreams



DEALERS
FOR CATALINA,
HUNTER AND
HANS CHRISTIAN
SAILBOATS

Long Beach-Naples
Newport Beach
San Diego
Wilmington

866-569-2248
877-389-2248
760-402-3868
877-599-2248
Cell 310-995-9989

www.heritageyachts.com



NEWPORT

54' Jeanneau DS, '06 \$449,000



LONG BEACH

54' Hunter, '82 \$107,000



LONG BEACH

50' CheoyLeeketch, '69 \$199,000



SAN DIEGO

43' Hunter 430, '95 \$108,000



LONG BEACH

42' Hunter 426 AC, '03 \$162,900



LA HARBOR

40' Catalina, '98 \$109,900



LONG BEACH

37' Hunter 376, '97 \$79,900



LONG BEACH

37' Pacific Seacraft, '90 \$139,000



LONG BEACH

37' Irwin MkIII, '78 \$49,000



NEWPORT

35' Hunter 356, '03 \$89,000



SAN DIEGO

34' Catalina, '88 \$40,000



SAN DIEGO

32' Hunter Vision, '98 \$66,400

SUMMER SAILING READY!

NEW LISTING



45' COLUMBIA, 1973
You won't believe it until you see it. Impeccably restored, very spacious and light. Custom woodwork, new electrical. Sail or live aboard. Now for \$79,500



55' HALLMAN SLOOP, 1982
\$165,000



45' EXPLORER KETCH, 1978
\$95,000



44' NAUTICAT, 1983
Asking \$164,500



51' FORMOSA, 1979
\$145,000



40' CANADIAN SAILCRAFT, 1987
\$75,000



REDUCED!

39' C&C CC, 1985
\$60,000



36' CATALINA, 1984
\$36,500



41' SCHOCK GRAND PRIX, 1984
\$57,000



33' SANTA CRUZ, 1978
\$35,000



31' BOMBAY CLIPPER, 1978
\$22,000

27' ERICSON, 1978...\$14,000 29' BENETEAU FIRST, 1985...\$13,000

NEW ERA yachts
POWER & SAIL

2021 Alaska Packer Pl., Grand Marina, Alameda, CA 94501
sales@newerayachts.com • newerayachts@sbcglobal.net
(510) 523-5988 • www.newerayachts.com

QUALITY YACHTS AND UNIQUE OPPORTUNITIES



BENETEAU 43 (2007) 2008 model year, *Living the Dream* has many extras (bow thruster, satellite TV, Gori prop, inverter, new canvas, Nu-Teak cockpit). Immaculately maintained, lightly used. **\$225,000**



LAZZARA 76 OPEN FLYBRIDGE (1995)
E'lan combines beauty and elegance with robust all-ocean construction. Emeryville, transferable end-tie. **\$625,000**



48' ROYAL HUISMAN/KOOPMANS KETCH (1970) *Lola* just completed an 18-month total refit (electronics, rigging, sails, mechanicals, electrical and paint). Sails like a dream. Must see. **\$369,000**

**Where
in the
world?**



We've sold and shipped brokerage boats to Uruguay, Turkey and Australia in the past year. We truly reach an international clientele.



www.kkmi.com/yacht-sales

(510) 236-6633 • cell: (510) 207-8041 • fax: (510) 231-2355
yachtsales@kkmi.com

530 W. Cutting Blvd., Pt. Richmond, CA 94804

The Bay Area's Premier Boatyard and Brokerage – An Unbeatable Combination



THE MULTIHULL COMPANY

THE WORLD'S LEADER IN MULTIHULL SALES AND SERVICE

www.multihullcompany.com

The Multihull Company is pleased to announce the opening of the Northwest Multihull Center on Puget Sound's Commencement Bay. The Northwest Multihull Center is a great starting place for buying or selling a catamaran or trimaran or to learn more about the world of multihulls. We are creating the West Coast's largest concentration of catamarans and trimarans to serve you better!

The Multihull Company is the world's largest international catamaran and trimaran brokerage. Our team of multihull experts offer several distinct differences including buyer and seller services, a powerful online presence, worldwide offices, displays at major national and international boat shows, newsletters and social marketing that inform and reach the right buyers and sellers. Visit us at www.MultihullCompany.com or at our new Northwest Multihull Center and see why The Multihull Company is truly the choice for sailors around the world.

FEATURED WEST COAST LISTINGS



50' CATANA, 2008
Washington
€700,000



42' SHUTTLEWORTH, 1983
Baja California
\$139,000



CATANA 471, 2001
Washington
\$545,000



35' SEAWIND, 2008
Alaska
\$248,000



34' GEMINI 105MC, 2008
Washington
\$149,000



36' CORSAIR C36, 2004
San Francisco, CA
\$199,500

SAN FRANCISCO SEATTLE FT. LAUDERDALE CHARLESTON FRANCE TURKEY TRINIDAD GRENADA TORTOLA ST. MARTIN
HQ Phone: 215-508-2704 Northwest Multihull Center: 206-297-1151 email: info@multihullcompany.com



Marotta Yachts of Sausalito

Brokers of Fine Sail and Motor Yachts

415-331-6200 • info@marottayachts.com • www.marottayachts.com

See at: www.marottayachts.com

REDUCED



46' KELSALL CATAMARAN, 2008 Well-found long-distance cruiser easily handled by a couple, bristol in and out. Twin Volvo diesels, 6kW Northern Lights genset, full electronics, 3-cabin/2-head layout, lying in Sausalito YH. **\$324,000**

See at: www.marottayachts.com



42' BENETEAU 423, 2003 Perfect example of this popular design. Two-stateroom, deep-draft version shows bristol in and out. New batteries and new running rigging, very low time on engine. Potentially transferable Sausalito YH slip. **\$169,000**

See at: www.marottayachts.com

REDUCED



34' GEMINI 105MC CATAMARAN, 2005
THE most successful cats ever designed. Just detailed, very nice inside and out. Never cruised, low hours on Westerbeke. **\$119,000**

See at: www.marottayachts.com



35' HINCKLEY YAWL, 1966

Only two owners, nice original condition with roller furler jib, new sails in 1999, Westerbeke diesel rebuilt in 2007, striking gray Awlgrippd hull. **\$70,000**

See at: www.marottayachts.com



28' ALERION EXPRESS, 2000

Lovely little daysailer shows as new for a fraction of the price of a new build. Very well equipped and lying in a potentially transferable Sausalito Yacht Harbor slip. **\$69,500**

See at: www.marottayachts.com



SISTERSHIP

37' BENETEAU FIRST 375, 1986

VERY clean and VERY well priced classic Beneteau lying in a potentially transferable Sausalito Yacht Harbor slip. **\$59,000**

See at: www.marottayachts.com



32' WESTSAIL, 1979 Factory finished, beautifully maintained was repowered in 2006 with a 40hp Volvo diesel, plus new mast and rerigged (2005), very clean inside and out. No teak decks, aluminum mast. Nicest we've seen in years! **\$49,500**

See at: www.marottayachts.com



SISTERSHIP

36' CANADIAN SAILCRAFT, 1986 Classic one owner CS in beautiful shape with rebuilt Westerbeke diesel and new standing rigging, and much more. Designed by Ray Wall of Camper and Nicholson, she's perfect for the Bay! **\$49,000**

See at: www.marottayachts.com

NEW LISTING



33' WAUQUIEZ GLADIATEUR, 1983 Classic European sloop in very nice shape above and below. With only three long term owners since new, she shows much newer than actual age – interior in particular shows very well. **\$47,500**

See at: www.marottayachts.com

NEW LISTING



36 ISLANDER, 1979

VERY clean Islander 36, one of the nicest we've seen in quite some time. Westerbeke diesel, dodger potentially transferable Sausalito Yacht Harbor slip. **\$35,000**

See at: www.marottayachts.com



30' FORTUNE PILOTHOUSE CUTTER, 1978

Charming custom pilothouse feels WAY bigger than 30-ft! Much new equipment. Pride of ownership throughout. Must see. **\$29,500**

See at: www.marottayachts.com



TWO C&C 34s, 1978 & 1981

Both are very clean and lying in potentially transferable Sausalito Yacht Harbor slips. (Picture shown is the 1981.) **\$29,000 and \$36,950** respectively.

at 100 BAY STREET • SAUSALITO • CALIFORNIA 94965 since 1946

NORPAC YACHTS

1150 Brickyard Cove Rd., B9, Pt. Richmond, CA 94801

(510) 232-7200 • FAX (510) 232-7202

email: info@norpacyachts.com

FALL IS A
GOOD TIME TO
BUY OR SELL...

WE HELP
WITH BOTH!

BRISTOL!

52' STEPHENS 1929 CLASSIC Raised deck express coastal cruiser. Absolutely BRISTOL condition. Exquisitely decorated and stunning custom built, one-of-a-kind Gatsby era gem. Twins, gen, flybridge, more! Asking **\$385,000**

REDUCED!

44' STEEL Canoe-stern cutter by Geo. Buhler/Fred Lagier & Sons. John Deere diesel. Stout steel construction. Awesome bluewater cruiser built to go to sea and stay there. Radar, GPS, etc. Here's your world beater! Asking **\$59,950**

OWNER
MAY FINANCE!

48' GRAND BANKS Trawler LRC. Aft master S/R, twin diesel, FB & PH helms, classic mahogany in BEAUTIFUL condition. Onan, fully loaded galley, 3 heads, shower & tub, inflatable dinghy w/ motor, swim platform, steadying sails, radar, MORE! Asking **\$90,000**

CRUISE NOW!

40' VALIANT CUTTER Great blue water cruising design that changed cruisers forever. Loaded with cruising gear, color radar, R/F, plotter, nav station, private staterooms, and MORE! A big, strong, performance world cruiser. Asking **\$69,500**

CRUISE NOW!

34' CATALINA Full cruise equipment. Baja Ha-Ha veteran and ready to go again. Aft and forward double staterooms, solar panels, radar and full electronics. Lots of gear. Dodger and bimini, spinnaker. Great condition and MORE! Asking **\$44,950**

PRICE CUT!

65' Wm. GARDEN LONG-RANGE TRAWLER YACHT Steel construction, F/B, large pilothouse and large salon area, aft canopy, twin diesel, genset, watermaker, radar, AIS, etc. Fully operational. Interior and trim not fully finished. A brownie cruiser robustly built. NOW ONLY **\$174,900**

COME
CRUISE WITH ME

38' ERICSON Sloop. Great Bruce King design. Diesel, roller furl., self-tending winches, dodger, full galley w/ fridge & freezer, radar, GPS, plot, etc. with repeaters, spinnaker, wheel/pedestal, solar panel, tender w/ motor, AP, liferaft, 2 dbl staterooms & MORE! Asking **\$58,500**

GREAT VALUE!

32' DOWNEASTER Cutter. An excellent cruiser with robust hand-laid glass construction. Good looks, roominess (6'6" headroom), comfort, cutaway forefoot full keel w/ hung rudder for stability, true tracking in a seaway & nimbleness in close quarters. MORE! Asking **\$32,500**

35' BENETEAU 350 Sloop. Diesel, roller furling, dodger, wheel steering, autopilot, double lifelines/pulpits, self-tailing winches, lines led aft, full galley, shower, two double staterooms, wing keel and more! Asking **\$44,950**

KAY OF GOTEBORG

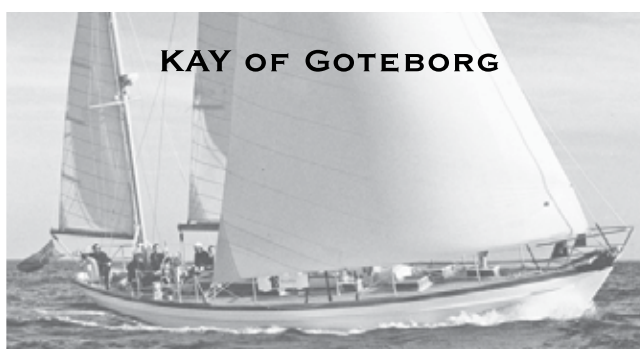

52' SPARKMAN & STEPHENS YAWL

by Walsted of Denmark, 1978. One of the finest vessels of her size and type on Earth. Copper-riveted double teak, diesel, dodger. The best of everything in the finest construction possible. This yacht is comparable to her sister *Dorada*. Magnificent, elegant. Exquisite: the Ultimate Classic Yawl. Asking **\$340,000**

END OF
SEASON SPECIAL

35' SPARKMAN & STEPHENS Center Cockpit Sloop. Diesel, aft stateroom, hard (fully enclosable) dodger, good sail inventory, wheel, extra strong fiberglass construction, well found quality cruising boat. Asking **\$17,950**

28' ISLANDER Sloop. Very clean and well found. Wheel steering, 190 hrs on just rebuilt Moyer/Atomic 4, jiffy reefing, enclosed marine head, Garmin GPS/chart plotter, 3 VHF's (including handheld), depth, more! Asking **\$14,950**

REDUCED!

31' LIEN HWA SEAHORSE Trawler. Nice, clean boat. F/G w/ varnished teak appointments. Economical dsl, 2 dbl berths, AP, H&C pressure water, swim platform w/ transom door, windlass, Bimini, settee/ship's table, F/B & P/H helms, dinghy davits. MORE! Asking **\$39,500**

30' CAPE DORY Cutter. Alberg design. One of the finest smaller bluewater cruisers ever built. Famous for comfort, durability, seaworthiness & stout construction. Dodger, near-new dsl, RF, radar, GPS, MORE! Asking **\$34,950**

29' CAL 29 Sloop. Solid, classic Lapworth design in sailaway condition. A fast fin-keeled beauty with a nearly new auxiliary diesel! Handles well and is a great daysailer or weekender — or for limited cruising. Roller furling, new LPU & MORE! Asking **\$19,500**

133' CAR FERRY Conversion: Office/Studio. Ultra spacious. Fully operational. Set up for very comfortable living and working. Ice Class, built in Norway. Fine condition. Absolutely unique and VERY cool. Rare opportunity. Asking **\$680,000**

36' KADEY-KROGEN MANATEE Trawler. Awesome roominess, storage space & comfort. Very economical, dsl powered. All F/G. Easy handling (has bow thruster). Easy to maintain. Ideal inshore cruiser/liveaboard. Covered berth kept, heater, two 2-person strms, F/B+-. Asking **\$98,000**

30' ISLANDER BAHAMA Sloop. Super clean and very nice! Diesel, wheel steering on pedestal, two mains, jib, genoa, spinnaker, VHF, depth, stereo, more. A bargain. GREAT BUY! Asking **\$14,900**

PLEASE SEE

www.norpacyachts.com

and/or

www.yachtworld.com/norpacyachts

for MORE BOATS

CALL (510) 232-7200 OR
TOLL FREE (877) 444-5087

OR CALL GLENN DIRECTLY AT

(415) 637-1181

FOR APPOINTMENTS & INFORMATION



The lowest bottom line in bottom painting!

HOME

SERVICES

LOCATIONS

STORE

YACHT SALES

GENERAL YARD

HAULS & LOADING

BOTTOM PAINTING
& REPAIR

FINISH PAINTING
& DETAILING

GEL COAT
& FIBERGLASS

WELDING
& FABRICATION

WOODWORKING
& CABINETRY

SYSTEMS & EQUIPMENT

RIGGING

ENGINES

ELECTRONICS

BOTTOM PAINTING & REPAIR



Since bottom painting is a routine maintenance task, we've streamlined the process by providing you with an Inclusive Package Price. Rather than paying an hourly labor rate plus the cost of materials, our years of experience (and highly efficient Team) allows us to provide you with a fixed price for this service. Call or email us for pricing on your boat!

KKMI is also skilled in:

- ▶ Repairing blisters
- ▶ Keel repairs
- ▶ Rudder repairs
- ▶ Structural repairs

HERB CRANE



THE BOTTOM LINE IS...when you own a boat you learn that some things cost more than you imagined. It's not that you're unwilling to spend the money but it sure is nice to know how much something will cost before you say, go ahead. I've learned...if I can rely on the boatyard to do something routine, such as painting the bottom, and the price they quoted me is the price I pay, then I'm a happy boat owner. It's been my experience that you can rely on the price quotes you receive from KKMI. If you've not been a client at either of their yards, you should give them a try.

PT. RICHMOND (510) 235-5584

SAUSALITO (415) 332-5564

WWW.KKMI.COM