



2017 Northern California **SAILING CALENDAR** AND YRA MASTER SCHEDULE

A Complete Racing Guide

Latitude 38

Pick one up. It's **FREE!**



WORLD CLASS



Roy Disney of *Pyewacket* won Cabo, PV, Transpac and Pacific Cup – and much more – with Easom Rigging.



Paul Dorsey won Big Boat Series Sportboat with the Easom-rigged Soto 30 *Gentoo*.



Mark English and Ian Rogers doublehanded their Easom-rigged Moore 24 *Mas!* to class and overall victory in the Pacific Cup.

If you want to win in 2017, call

ON THE BAY

Easom Brings Global and Grand Prix Experience to the Bay

Easom Rigging's experience winning on the front lines of the global grand prix race circuit brings unbeatable rigging and race management to anyone who wants to compete at the highest levels on the Bay or anywhere.

Every rigger has access to great products, but only Easom has the experience and knowledge to reliably offer superior execution and race-winning results. Our travels to race venues on the East Coast, Europe and across the U.S. gives you access to the latest in rigging technology and technique.

Call us for your rigging upgrades or complete race project management.

For a job done right, contact:



Easom Racing and Rigging

1150 Brickyard Cove Rd. Suite B1
Point Richmond, CA 94801

(510) 232-SAIL (7245)

seasom@sbcglobal.net



Joel Ronning won the J/70 Worlds on San Francisco Bay.

Easom Rigging today

nke
MARINE ELECTRONICS

MULTIGRAPHIC

One display
for full control

User-friendly graphical color
multifunction display
and sunlight
readable

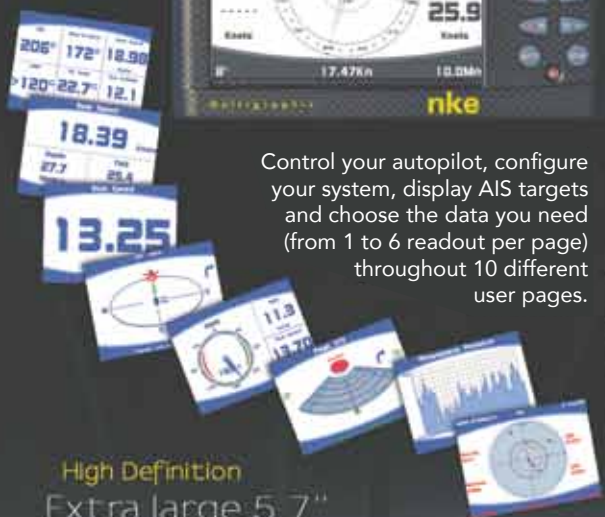

Control your autopilot, configure
your system, display AIS targets
and choose the data you need
(from 1 to 6 readout per page)
throughout 10 different
user pages.

High Definition
Extra large 5.7"
Viewing angle greater
than 160°
Low power consumption



nke-marine-electronics.com

Euro Marine Trading, Inc., 62 Halsey St., Unit M, Newport RI 02840
T (401) 849-0060 - F (401) 849-3230
www.euromarinetrading.com - info@euromarinetrading.com

CONTENTS

Welcome to the YRA	7
YRA Contact Information	8
2016 Season Winners	10
Sponsoring Clubs	12
Yacht Club Alphabet Soup	14
Additional Associations	14
PHRF Committee	16
Racing Rules	18
Equipment Requirements	20
Beer Can Racing	22-25
Caribbean Circuit	26
Midwinter Series	28-29
Shorthanded Circuit	30
Fleet Schedules	32-33
Central Bay Marks	34-35
North Bay Marks	36
YRA Racing Areas	37-38
South Bay Marks	39
NCPHRF Application How-To	40-48
YRA Races	41-47
PHRF Application	49
Race Signal Flags	50
Monthly Calendar Pages	51-73
Youth Sailing	52-60
VHF Radio Channel Uses	64
Women's Circuit	68
Pacific Ocean Events	70
<i>Latitude 38</i> Contact Information	72
Sunrise/Sunset Times	72
SF Bay Current Charts	74-79
Weekend Currents	80-81
Advertisers Index/Alpha Index	82

Cover: Returning to the Bay on the OYRA Crewed Lightship.

Photo by Leslie Richter / www.rockskipper.com

Graphic Design: *Latitude 38* / Annie Bates-Winship & Colleen Young

Questions concerning the 2017 YRA Calendar should be addressed to
the YRA office at (415) 771-9500 or the appropriate class association.

Check the monthly edition of *Latitude 38* and www.latitude38.com for calendar updates.

EXCEL UNDER PRESSURE

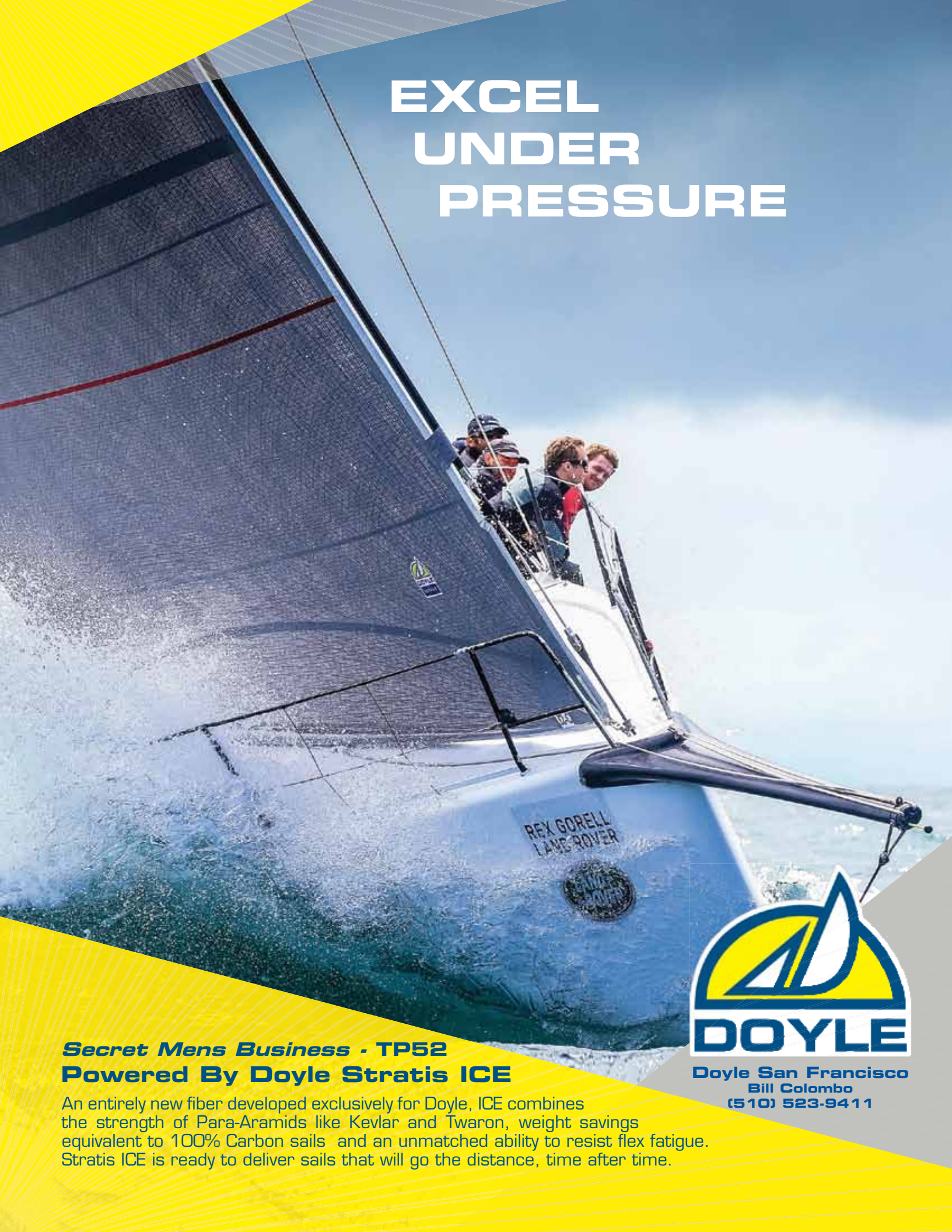

***Secret Mens Business* - TP52 Powered By Doyle Stratis ICE**

An entirely new fiber developed exclusively for Doyle, ICE combines the strength of Para-Aramids like Kevlar and Twaron, weight savings equivalent to 100% Carbon sails and an unmatched ability to resist flex fatigue. Stratis ICE is ready to deliver sails that will go the distance, time after time.



Doyle San Francisco
Bill Colombo
(510) 523-9411

ISLAND YACHT CLUB

Located adjacent to Svendsen's Marine
in the Alameda Marina
1853 Clement Avenue, Building 14

2017 RACING SCHEDULE

1/8, 2/12, 3/12: Estuary Midwinters Island Days

Mar 5: Sadie Hawkins Woman-Skippered Race on the Estuary, Full Crew

Apr 8: 36th Annual Doublehanded Lightship



Apr-Sept: Spring & Summer Twilight Series
Friday evening beer can racing

Apr-Sept: Interclub Races

June 24: Silver Eagle Long Distance Race,
Classic Course and Shortened Course

Sept 23-24: Northern California
Women's Sailing Seminar & Regatta
'Capture the Power', with flat water
Estuary racing on September 24

Nov 5: Jack & Jill +1 Woman-Skippered
Triplehanded Race on the Estuary

Nov 19: Commodore's Challenge

**Nov '17-
Mar '18:** Estuary Midwinters Island Days
Second Sundays of each month

• Sadie and Jack & Jill are counters in the *Latitude 38* Woman's Circuit •
Member of PICYA



For information, see
www.iyc.org
racing@iyc.org • (510) 521-2980

THE YRA WELCOMES YOU TO THE 2017 RACING SEASON

Welcome to the YRA's 2017 Racing Season! We've got lots of racing opportunities planned for everyone, and the best racing value on the Bay. Whether you sail a multihull, a classic woody or a one-design boat, sail on the ocean or under PHRF in the Bay, we've got races waiting for you.

This is your reminder that it's time to renew your PHRF certificate and sign up to race for the new year! There are three options when signing up for a 2017 PHRF certificate:

NEED A NEW CERTIFICATE?

Boats that need a new certificate should fill out a new PHRF application and send the application to info@yra.org. You can find the application at <http://yra.org/northern-california-phrf/about-ncphrf/> and on page 49 of this book.

HAVE NO CHANGES TO 2016 PHRF CERTIFICATE?

Boats that had a certificate in 2016 and have no changes to their 2017 certificate should simply register for a new certificate by going to www.jibset.net.

NEED TO MAKE CHANGES TO 2016 PHRF CERTIFICATE?

If you had a 2016 certificate and need to make changes to your certificate for 2017, please contact Laura Muñoz at the YRA office via info@yra.org to see if you need a specific form.

For 2017, the YRA racing season offers four different racing options:

YRA SERIES: A four-day series with two races scheduled for each race day. Divisions for one-design fleets, sportboats and PHRF boats available.

OYRA SERIES: Nine ocean races are scheduled again this year, with divisions for fully-crewed boats as well as shorthanded and singlehanded crews.

CLASSIC BOAT SERIES: A five-day series with two races scheduled for each race day. Participating fleets currently include the Alerion Express 28s, Bears, Birds, Cal 20s, IODs, Folkboats, Knarrs, and Santana 22s. Other classic one-design fleets are always welcome!

WEEKEND REGATTAS: The Great Vallejo Race, the Westpoint Regatta, the 2nd Half Opener, and the Season Closer. YRA's four marquee events with divisions for all types of racers.

You can find information on the different racing opportunities in this publication and on the YRA website. When you're ready to sign up, visit www.yra.org to enter electronically.

We encourage everyone to get a YRA membership and sign up to race. Your membership support and participation in the YRA all goes to help us do everything we do. And we do a lot:

- Administer the local PHRF database; almost 700 certificates issued in 2016. YRA members receive discounts on PHRF fees and complimentary changes throughout the year!
- Coordinate with the US Coast Guard to process event permits; more than 800 permits in 2016.
- Maintain racing buoys in the Bay.
- Host the US Sailing Area G Appeals Committee.
- Advocate for sailing and racing in the Bay Area.
- Administer and coordinate the OYRA, weekend regattas, classic boat, and the YRA racing series.

We want to thank the YRA members, yacht clubs and their race committees who are sponsoring this year's YRA races. We couldn't do it without you and your support. We know each YRA skipper and crew thanks you as well.

Be sure to follow us on Twitter and Facebook to keep up with all the latest YRA news. You can find us on Twitter at [YRAofSFBay](https://twitter.com/YRAofSFBay) and on Facebook at the YRA of SF Bay page!

Get those certificates renewed and get your entries in soon! We look forward to seeing you out on the starting line for every race you're scheduled to sail!

Fair winds to all,
Don Ahrens,

Chairman of the Board, chairman@yra.org

Laura Paul, Executive Director, info@yra.org

Yacht Racing Association of San Francisco Bay

1070 Marina Village Parkway, #202-G, Alameda, CA 94501

(415) 771-9500; Fax (415) 276-2378, info@yra.org; www.yra.org



Don Ahrens



Laura Muñoz

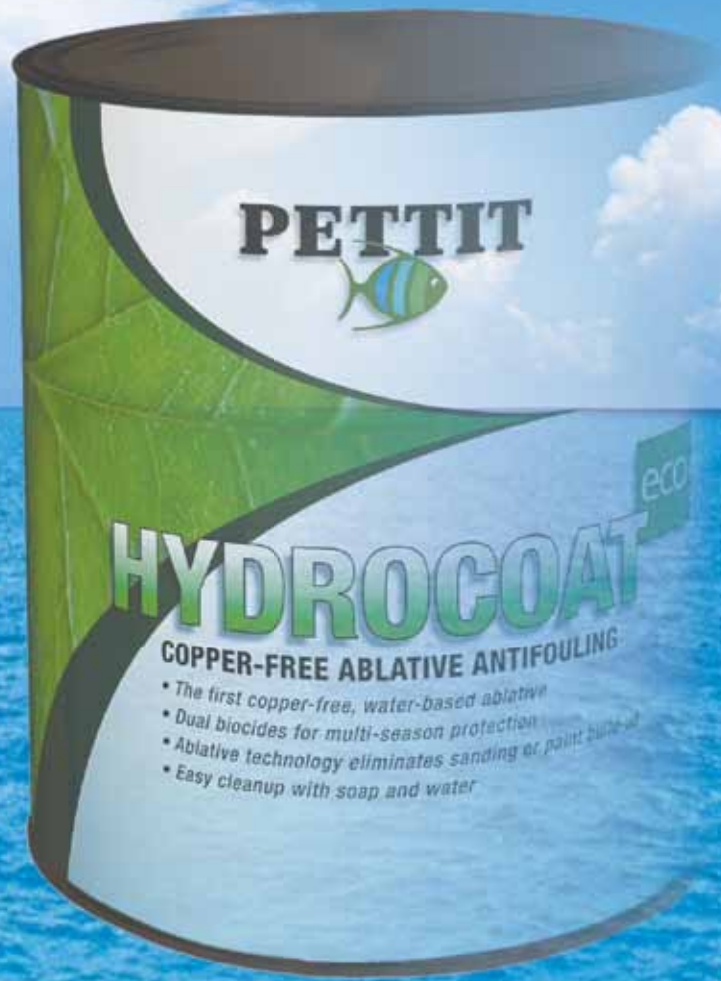

AIR AND SEA WILL NEVER KNOW.

All you sceptics who believe you can't get real fouling protection without heavy loads of copper and solvent, meet the mind changer. Hydrocoat ECO. Water-based Hydrocoat ECO is a new clean world of solvent-free antifouling. It contains the breakthrough additive Ecomea that reduces copper by 100% yet delivers 100% of the copper effectiveness. It's all about maximum protection with minimum impact. It's a clean new day.



HYDROCOAT^{eco}

Copper-Free Ablative Antifouling

pettitpaint.com • 800-221-4466

Oakland Yacht Club



100 years
and counting
Founded 1913

2017 Racing Events

Sunday Brunch Series

January 15, January 22,
January 29,
February 19, February 26
March 19, March 26

First Gun 12:00

New racers always welcome.

Rites of Spring Saturday, March 11

*Singlehanded, Doublehanded
and Full Crew.*

Sweet Sixteen Wednesday Night Series

April 26 • May 3-31
June 7&14
July 12-26 • August 2-30

First Gun 18:00

*Challenging courses in protected waters.
Great food, fun and prizes at the
clubhouse afterwards.*

Oktoberfest Saturday, October 14

*Celebrate the spirit of Lederhosen and Dirndl
in a race around Treasure Island to the
clubhouse and have beer, brats and prizes!*

- Please join us on race day for a cocktail or meal
- Awards given after every race
- Guest docks available

See our website for race details and entry forms

oaklandyachtclub.net

Sail, Motor, or Drive to OYC

N37 47.008, W122 15.096

1101 Pacific Marina, Alameda, CA 94501

Phone: (510) 522-6868

Fax: (510) 522-7378

email: oycracecom@gmail.com

Accepting new member applications.

YRA CONTACTS

BOARD OF DIRECTORS

CHAIRMAN OF THE BOARD* 2017-2018: Don Ahrens
(415) 308-9771, chairman@yra.org

IMMEDIATE PAST CHAIRMAN* 2015-2016: Charles Hodgkins
(510) 504-4076, charles@sailingmischief.com

SECRETARY* 2016-2017: Bob Naber
Hm (510) 769-0309, k38bob@aol.com

TREASURER* 2016-2017: Bobbi Tosse
Hm (925) 939-9885, Fax (925) 906-9282, bobbijfcbat.com

EXECUTIVE DIRECTOR: Laura Muñoz
Wk (415) 771-9500, Cell (415) 994-4711,
Fax (415) 276-2378, info@yra.org

**Executive Committee*

DIRECTORS AT LARGE

2015-2016 Vallejo YC Representative: (707) 643-1254, info@vyc.org

2015-2016 Corinthian YC Representative: (415) 435-4771, info@cyc.org

2016-2017 Sequoia YC Representative: (650) 361-9472, office@sequoiayc.org

2016-2017 Encinal YC Representative: (510) 522-3272, info@encinal.org

SERIES PRESIDENTS

In-the-Bay Series (Includes HDA/ODCA): Rich Pipkin
(510) 377-3269, rpipkin@aerosources.biz

Ocean Series (OYRA): Andy Newell
(408) 391-0963, andy.newell@sbcglobal.net

Classic Boat Series (CBRA): Robert Thalman
Hm (415) 479-3281, Fax (415) 499-8077, bobthalman@aol.com

CBRA, YRA REPRESENTATIVE: Don Wilson
Hm (510) 527-1619, windansea@sprintmail.com

COMMITTEES

BUOYS: Patrick Hind-Smith
(415) 328-2819, psman99@hotmail.com

PHRF: (415) 771-9500, phrf@yra.org
See page 16 for PHRF (Performance Handicap Racing Formula) committee.

US SAILING

DIRECTOR, AREA G: John Siegel
Hm (408) 234-0422, jasiegel@earthlink.net

AREA REGIONAL ADMINISTRATIVE JUDGE: Mike Gross, (831) 476-2054,
mike.gross@charter.net

ARO, AREA G: Nancy DeMauro
(415) 630-0002, ndemauro@hotmail.com

APPEALS COMMITTEE

John Christman, Hm (510) 797-5524, Cell (510) 410-6771,
Fax (510) 790-3273, john.christman@jc2tech.com

Mike Gross, (831) 476-2054, mike.gross@charter.net

Paul Kamen, Hm (510) 540-7968, Fax (510) 540-6324, pk@well.com

Tom Roberts, Hm/Wk (415) 898-7802, tensleyrob@aol.com

John Siegel, (408) 234-0442, jasiegel@earthlink.net

Latitude 38 has made every effort to ensure the accuracy of all information, but please confirm your schedule with your fleet captain and look in the monthly Latitude 38 Race Calendar or on www.latitude38.com for changes. Due to space limitations, not all information could be included.

Let the professionals at our full service
boatyard help you prep and maintain
your boat for the 2017 sailing season!

Our mission is to guarantee absolute satisfaction to every customer.



310 West Cutting Blvd.

Point Richmond, CA 94804

510.237.0140

www.baymarineboatworks.com

CONGRATULATIONS 2016 SEASON WINNERS

YRA SERIES

PHRF: *Ahi*, Santana 35, Andy Newell, BYC
J/88: *Courageous*, Gary Panariello, SYC
Olson 25: *Shark on Bluegrass*, Falk Meissner, BYC
Santana 22: *Meliki*, Deb Fehr, IYC

OYRA SERIES

PHRO 1: *Blue*, Swan 53, Ray Paul, TIYC
PHRO 2: *Yeti*, Express 27, Adam Mazurkiewicz, SSS
Shorthanded: *Nancy*, Wyliecat 30, Pat Broderick, SSS
Singlehanded: *Ragtime!*, J/92, Bob Johnston, RYC
Multihull Division: *Raven*, F-27,
Truls Myklebust, BAMA

CBRA SERIES

Alerion Express 28: *Jewel*, Ron Tostensen, RYC
Bear: *Magic*, Tim Maloney, MMBA
Bird: *Cuckoo*, Bill Clausen, RYC
Cal 20: *Baby Blue*, Craig McDow, CYC
Folkboat: *Polperro*, Peter Jeal, BVBC
Knarr: *Knarrly Boo*, Jason Holloway, StFYC

SSS

Singlehanded Monohull: *Fugu*, Wilderness 30,
Chris Case, RYC
Singlehanded Multihull: *Wingit*, F-27, Amy Wells,
BAMA
Doublehanded Monohull: *Outsider*, Azzura 310,
Greg Nelsen, SSS
Doublehanded Multihull: *Wingit*, F-27, Amy Wells,
BAMA

SMALL BOATS

El Toro Seniors: *Cygnus*, Art Lange, FSC/HPSC
El Toro Juniors: *Bull Shark*, Connell Phillipps, RYC
Mercury: *Axon*, Doug Baird, SFYC
Vanguard 15: Dan Altreuter, TISC
Laser: *Seaweed Magnet*, Emilio Castelli, RYC
Laser Radial: *Voyager I*, Toshinari Takayanagi,
Shoreline Lake YC
Mixed Rig Laser: *C'est la Vie*, JB Duler,
StFYC

OVERALL FLEET WINNERS FROM 2016 GREAT VALLEJO RACE WEEKEND

PHRF 1: *Bodacious+*, 1D48, John Clauser, BYC
PHRF 2: *Chance*, Farr 395, Stan Hales, SFYC
PHRF 3: *Encore*, Sydney 36, Wayne Koide, RYC
PHRF 4: *Courageous*, J/88, Gary Panariello
PHRF 5: *Hoot*, Olson 30, Andrew Macfie, RYC
PHRF 6: *Arcadia*, Nash 27, Gordie Nash, RYC
PHRF 7: *Kelika*, Hunter 33.5, Michael Weaver, VYC
PHRF 8: *Downtown Uproar*, J/24, Darren Cumming,
SSS
PHRF 9: *Tchoupitoulas*, Santana 22,
Stephen Buckingham, SSS

SF 30: *Wind Speed*, Tony Castruccio, RYC
Sportboat 1: *Leenabarca*, Melges 32, Bill Erkelens,
RYC
Sportboat 2: *Salsa*, Ultimate 20, David Krausz, SSS
Non-Spinnaker: *Basic Instinct*, Elliot 10.5,
Memo Gidley, CYC
Cal 40: *Azure*, Rodney Pimentel, EYC
Express 27: *Abigail Morgan*, Ron Kell, CYC
Express 37: *Mudshark*, David Fullerton, PresYC
IOD: *One Hundred*, Paul Zupan, SSS
J/105: *Blackhawk*, Kristin Simmons, StFYC
Olson 25: *Shark on Bluegrass*, Falk Meissner, BYC
Multihull: *Wingit*, F-27, Amy Wells, BAMA

AND MORE...

BAMA Cup: *Ma's Rover*, Corsair F-31R,
Mark Eastham, BAMA
BAMA Fast Cat: *Smart Recruiters*, Extreme 40,
Jerome Ternynck, StFYC
Etchells: *Capricorn*, Ethan Doyle, SFYC
Express 27 Championship: *Motorcycle Irene*,
Will Paxton/Zachery Anderson, RYC
Express 27 Long Distance Series: *Abigail Morgan*,
Ron Kell, CYC
Express 37: *Golden Moon*, Express 37,
Kame Richards, EYC
Islander 36: *Windwalker*, Richard & Tom Shoenhair,
SSS
J/24: *Downtown Uproar*, Darren Cumming &
Melissa Litwicki, SSS/OPBYC
J/105: *Godot*, Phillip Laby, NoYC
J/111: *Bad Dog*, Dick Swanson, StFYC
J/120: *Peregrine*, David Halliwill, StFYC
Melges 24: *Looper*, Duane Yoslov, SFYC
Moore 24: *Gruntled*, Bart Hackworth/Simon Winer,
RYC
SF Bay 30: *Heart of Gold*, Olson 911S, Joan Byrne,
SBYC
Ultimate 20: *Uhoo!*, Michael Josselyn, RYC
Wylie Wabbit: *Kwazy*, Colin Moore, RYC



SERGEI ZAVARIN

Go get 'em in 2017!



ENCINAL YACHT CLUB PRESENTS

SUMMER SAILSTICE 2017

A Global Celebration of Sailing

SATURDAY

JUNE 24

- Sailstice Small Boat Races
- Compete in boat building contest
- Cruise in to EYC Sailstice Festival
- Music, food, activities
- Master Mariners boats on display

Learn more and sign up to win from over 400 prizes at
www.summersailstice.com/sf

EYC 2017 CALENDAR

JUNIOR SAILING PROGRAM

Year Round: (510) 769-0221

JACK FROST MIDWINTERS

January 21, February 25, March 18, November 18

BAYS OPTI REGATTA

February 11-12

MERCURY SERIES

March 4, April 8, May 13, June 3

SMALL BOAT SPRING & SUMMER SERIES

March 18 through September 17

PCISA SILVER CHAMPIONSHIPS

April TBD

FRIDAY NIGHT ESTUARY

SPRING & SUMMER TWILIGHT SERIES

April 7 through September 8

ESTUARY CUP April 9

CALIFORNIA OFFSHORE RACE WEEK

Spinnaker Cup: May 26 or 27, Coastal Cup: May 29,
In-Port Race: May 31, SoCal 300: June 1

CHISPA June 17

SIR FRANCIS CHICHESTER RACE June 17

SUMMER SAILSTICE June 24

FOURTH OF JULY REGATTA July 4

BAYS SVENDSEN'S SUMMER SPLASH July 15-16

2ND HALF OPENER July 29-30

FINN NATIONALS August 5-6

GRACIE & GEORGE REGATTA August 20

MILLIMETER NATIONALS September 9-10

COMMODORE'S CUP September 10

BART'S BASH September 17

BAYS HS NORCAL REGATTA November 4-5



See website for complete calendar of EYC events

Guests are invited to visit the Club, in Alameda, by land, sea or the web
ACCEPTING MEMBERSHIP APPLICATIONS

For Race, Berthing, Dining & Membership Information, call (510) 522-3272

www.encinal.org

YOU'RE INVITED

★ ALL BOATS WELCOME ★

2017 CORINTHIAN RACING:

65th Annual Midwinters:

- January 21-22
- February 18-19

Friday Night "Beer Can" Series:

- April 14-August 25

X-Bay Friendship Regatta:

- June 3

CYC One-Design Invitational:

J/105, Express 27, Moore 24, plus...

- June 17-18

Master Mariner's Boat Show:

- June 25

OYRA/SSS Drake's Bay Regatta:

- August 12-13

YRA Season Closer:

- September 30-October 1

Sign up to enjoy great racing and great hospitality with all your favorite competitors.

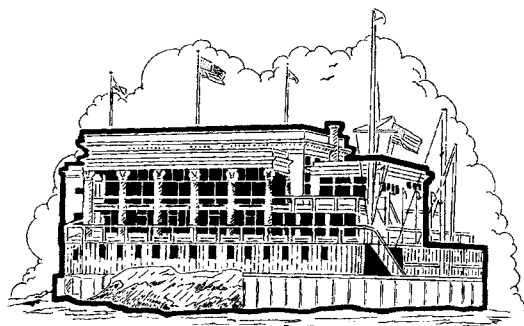

Corinthian Yacht Club

OF SAN FRANCISCO

43 MAIN, TIBURON, CA 94920 • (415) 435-4771

Visit our website: www.cyc.org

CALL TO HOST YOUR 2018 CHAMPIONSHIPS

SPONSORING CLUBS

BERKELEY YACHT CLUB (BYC) • (510) 843-9292
Bobbi Tosse c/o BYC, 1 Seawall Drive, Berkeley 94710

CORINTHIAN YACHT CLUB (CYC) • (415) 435-4771
Marcus Canestra, c/o CYC, 43 Main Street, Tiburon 94920

ENCINAL YACHT CLUB (EYC) • (510) 522-3272
c/o EYC, 1251 Pacific Marina, Alameda 94501

GOLDEN GATE YACHT CLUB (GGYC) • (415) 346-BOAT
Ray Davis, c/o GGYC, 1 Yacht Road, San Francisco 94123

HALF MOON BAY YACHT CLUB (HMBYC) • (650) 728-2120
Steve Smith c/o HMBYC, PO Box 52, El Granada 94018

RICHMOND YACHT CLUB (RYC) • (510) 237-2821
Doug McVae c/o RYC, PO Box 70295, Pt. Richmond 94807

ST. FRANCIS YACHT CLUB (StFYC) • (415) 563-6363
Graham Biehl c/o StFYC, On the Marina, San Francisco 94123

SAN FRANCISCO YACHT CLUB (SFYC) • (415) 789-5647
Lisa Turner c/o SFYC, PO Box 379, Belvedere 94920

SAUSALITO YACHT CLUB (SYC) • (415) 331-9147
Chuck Cihak c/o SYC, PO Box 267, Sausalito 94966

SEQUOIA YACHT CLUB (SeqYC) • (650) 364-9643
Rick Dalton c/o SeqYC, 441 Seaport Court, Redwood City 94063

SOUTH BEACH YACHT CLUB (SBYC) • (650) 302-1187
Dan Courter c/o SBYC
Pier 40 on the Embarcadero, San Francisco 94107

VALLEJO YACHT CLUB (VYC) • (707) 643-1254
Dave Nadolne c/o VYC, 485 Mare Island Way, Vallejo 94590



Thanks to all yacht clubs, advertisers and race committees for their support!

FRICTION DEVICES



MXL SNATCH RINGS

Optimal Weight To Working Load Ratio

MXL soft blocks are ideal for applications where lines are under heavy semi-static loads. Featuring higher working loads than standard blocks of the same size, the MXL improves onboard performance. Used as a snatch block, it can be easily installed and removed in a few seconds. It is also a great product to keep as a spare for any emergency situation.

Model	Max Line Ø	Height	Weight oz	WL lbs
MXL6	8mm - 5/16"	35mm - 1 3/8"	.70	1,985
MXL8	10mm - 3/8"	45mm - 1 3/4"	1.41	3,086
MXL10	14mm - 9/16"	55mm - 2 5/32"	2.89	3,968



FRX RINGS

Reliability, Light Weight And Versatility

FRX Rings are ideal for applications where lines are under heavy semi-static loads, or to defect lines throughout the boat. Rigged with a soft attachment, the FRX ensures light weight and effective angle deflection for multiple applications onboard.

Model	Ø A	Ø B	WL lbs	Weight oz
FRX 6	13/16"	9/32"	881	.07
FRX 10	5/16"	3/8"	1,763	.17
FRX 15	3/8"	19/32"	3,527	.42
FRX 20	9/16"	25/32"	7,054	1.09
FRX 25	21/32"	63/64"	11,023	2.01

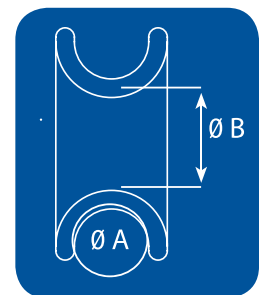
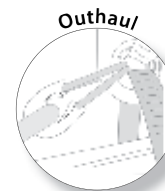

www.wichardamerica.com

Wichard Inc

Tel: +1 (401) 683-5055 | Fax: +1 (802) 655-4689 | Email: info@wichard-usa.com



CLIP AND SAVE! ✂

PIRATES + LAIR 2017 SAVINGS!

20% OFF—Club and Team Orders*

Save 20% off any custom yacht club or racing team order over \$100.

- Sublimated Wicking Shirts
- Embroidery
- Screen Printing

*Valid for one order per customer in 2017.

10% OFF—Online Store

Use coupon code 17LAT38 for 10% off at store.pirateslair.com. Expires 12-31-17.

Check out new merch online:

Oracle Team USA & America's Cup 2017

Official Merchandise by Sail Racing!

50+ New Mount Gay® Rum Items for 2017

CLIP AND SAVE! ✂

SAIL RACING

Gill Hanes

CUTTER & BUCK

GILDAN

PORT AUTHORITY



PIRATES + LAIR

888.SAIL.BUM

WWW.PIRATESLAIR.COM

©2017 Mount Gay Distillerly Ltd., Mount Gay® Barbados Rum, 40% Alc/Vol, Imported by Rémy Cointreau USA, Inc., New York, N.Y. Eclipse Design® Be Confident. Drink Responsibly.

YACHT CLUB ALPHABET SOUP

ABYC	Alamitos Bay Yacht Club	LYSA	Lake Yosemite Sailing Association
ACSC	Alameda Community Sailing Center	MBYC	Mission Bay Yacht Club
AYC*	Alameda Yacht Club	MMBA	Master Mariners Benevolent Association
AeoYC*	Aeolian Yacht Club	MPYC*	Monterey Peninsula Yacht Club
BAADS	Bay Area Association of Disabled Sailors	MYC*	Marin Yacht Club
BAMA*	Bay Area Multihull Association	NHYC	Newport Harbor Yacht Club
BBYC*	Ballena Bay Yacht Club	NOSA	Newport Ocean Sailing Association
BVBC*	Bay View Boat Club	OPYC*	Oyster Point Yacht Club
BYC*	Berkeley Yacht Club	OYC*	Oakland Yacht Club
BenYC*	Benicia Yacht Club	PCYC	Pacific Cup Yacht Club
CBYC	Cabrillo Beach YC	PICYA	Pacific Inter-Club Yacht Association
CGRA	Columbia Gorge Racing Association	PYSF	Peninsula Youth Sailing Foundation
CMA	Cal Maritime Academy	PresYC*	Presidio Yacht Club
CN	Club Nautique	RYC*	Richmond Yacht Club
CPYC*	Coyote Point Yacht Club	SBYC*	South Beach Yacht Club
CSC*	Cal Sailing Club	SCYC*	Santa Cruz Yacht Club
CYC*	Corinthian Yacht Club	SDYC	San Diego Yacht Club
CaIYC	California Yacht Club	SFYC*	San Francisco Yacht Club
DSC*	Diablo Sailing Club	SJSC*	San Jose Sailing Club
EYC*	Encinal Yacht Club	SLYC	San Leandro Yacht Club
EIKYC*	Elkhorn Yacht Club	SPYC*	Sierra Point Yacht Club
EmYC*	Emeryville Yacht Club	SRYC*	San Rafael Yacht Club
FLYC*	Folsom Lake Yacht Club	SSC*	Stockton Sailing Club
FSC	Fremont Sailing Club	SSS*	Singlehanded Sailing Society
FYC*	Fresno Yacht Club	SYC*	Sausalito Yacht Club
GCYC*	Gold Country Yacht Club	SeqYC*	Sequoia Yacht Club
GGYC*	Golden Gate Yacht Club	StFYC*	Saint Francis Yacht Club
HLBC	Huntington Lake Boat Club	TISC	Treasure Island Sailing Center
HMBYC*	Half Moon Bay Yacht Club	TIYC*	Treasure Island Yacht Club
HRYC	Hood River Yacht Club	TPYC	Transpacific Yacht Club
HYC	Humboldt Yacht Club	TYC*	Tiburon Yacht Club
IYC*	Island Yacht Club	Tahoe YC*	Tahoe Yacht Club
InvYC*	Inverness Yacht Club	VYC*	Vallejo Yacht Club
LAYC	Los Angeles Yacht Club	WSC*	Whiskeytown Sailing Club
LBYC	Long Beach Yacht Club		
LGYC*	Los Gatos Yacht Club		
LMSC	Lake Merritt Sailing Club		
LTWYC*	Lake Tahoe Windjammers Yacht Club		
LWSC	Lake Washington Sailing Club		

*YRA Member Clubs

ADDITIONAL ASSOCIATIONS

- **BAADS:** Bay Area Association of Disabled Sailors (415) 281-0212, www.baads.org
- **BAMA:** Bay Area Multihull Association
Bob Naber, sfbchair@sfbama.org, www.sfbama.org
- **BAYS:** Bay Area Youth Sailing
www.bayarea-youthsailing.com
- **MMBA:** Master Mariners Benevolent Association
(415) 364-1656, mastermariners@hotmail.com, www.mastermariners.org
- **NCORC:** Northern California Ocean Racing Council
www.norcalorc.org
- **PICYA:** Pacific Inter-Club Yacht Association
Lynda Myers, (415) 602-9961, lyndapicya@gmail.com, www.picya.org
- **SSS:** Singlehanded Sailing Society
(866) 724-5777, racechair@sfbaysss.org, www.sfbaysss.org
- **U.S. COAST GUARD** (Marine Event Permits):
(415) 399-3440, Fax (415) 399-3480, www.uscg.mil
- **US Sailing:**
15 Maritime Dr., Portsmouth, RI 02871
(401) 683-0840, (800) 877-2451, info@ussailing.org, www.ussailing.org



FORMERLY
STRICTLY SAIL PACIFIC

PACIFIC SAIL & POWER BOAT SHOW *and Marine Sports Expo*

April 6-9, 2017

Craneway Pavilion and
Marina Bay Yacht Harbor
Richmond, CA

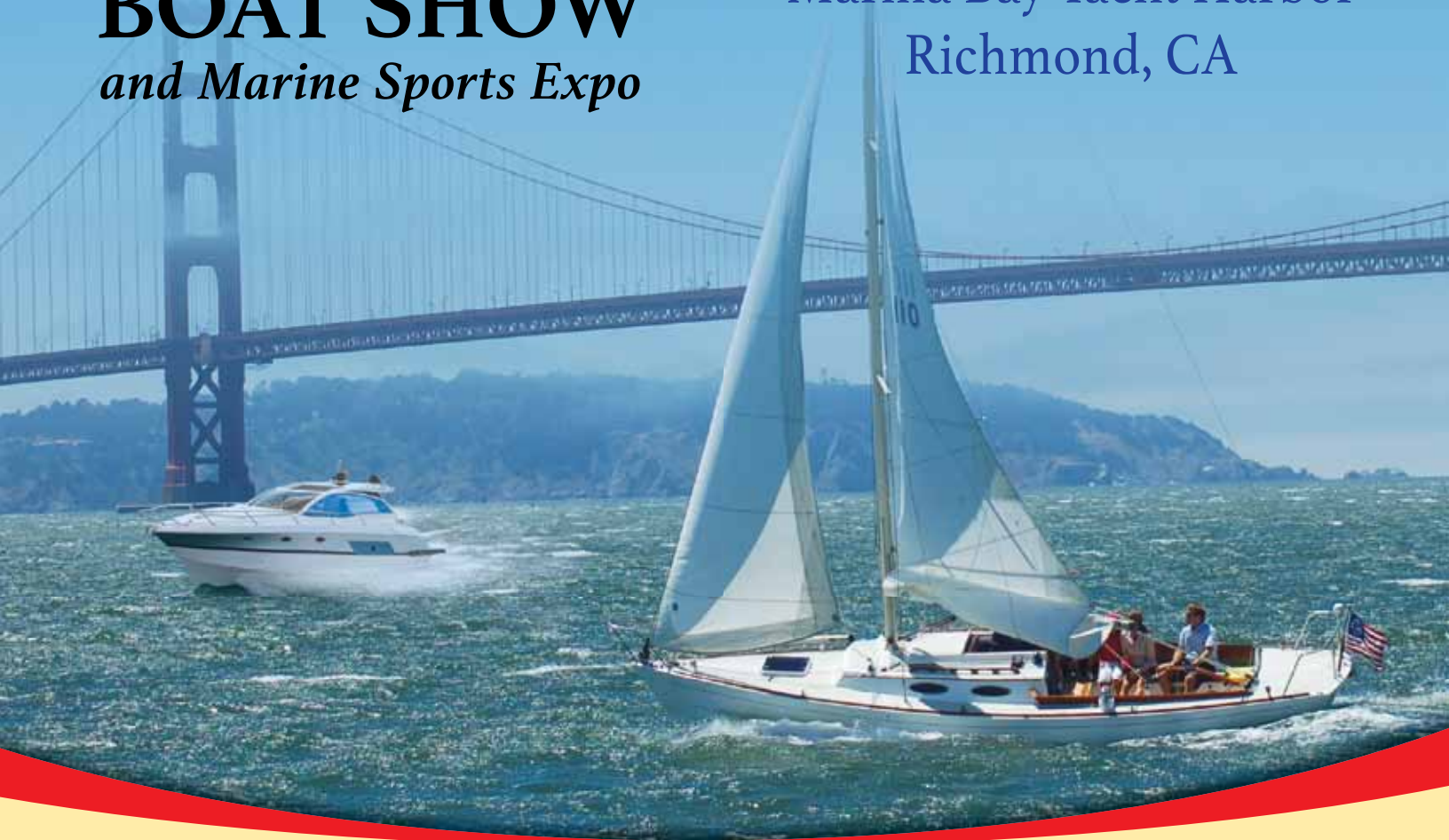

50,000 sq. ft. of Exhibitors on Land • On-The-Water Training Clinics

In-Water Displays of the Newest Sail and Power Cruising Boats

Special Events Daily • On-Site Parking

Hundreds of Seminars to Expand Your Knowledge

PacificBoatShow.com



Produced by:



PERFORMANCE MATTERS

J/Boats and Performance Brokerage

New
J/121



J/111



J/88



J/70



Buying or selling, we know the market for one design, ORR, PHRF, TP52, custom built... you name it!

If you're looking for a winning season, contact:

SAIL California

www.sailcal.com

ALAMEDA: (510) 523-8500

Norman Davant
norman@sailcal.com

Rod Kux
rod@sailcal.com

Pat Nolan
pat@sailcal.com

SAN FRANCISCO: (415) 543-7333

Drew Harper
drew.harper@me.com

Garrett Greenhalgh
soulofsailing@gmail.com

PHRF COMMITTEE 2017

If you have a custom or modified sailboat, your boat may need to have its rating reviewed and assigned by the local volunteer PHRF committee. With your boat's measurements, the committee will provide a fair rating so you can quickly join the Bay Area racing scene. From evening beer can racing to offshore regattas to just about every other keelboat race on the Bay, a PHRF rating will make it easy to sign up and start sharpening your skills on the race course. You can fill out the rating form on page 49 with help from detailed instructions provided on page 40.

The YRA also wants to thank the committee members below for their tireless efforts at supporting fun, fair racing on San Francisco Bay.

Antrim, Jim

Wk (510) 223-9680, Fax (510) 262-0303,
jka@antrimdesign.com

Colombo, Bill

c/o Doyle Sails, Wk (510) 523-9411, Cell (510) 773-8015,
Fax (510) 523-9433, doylepacific@gmail.com

Dees, Brooks

Wk (510) 691-2009, brooks@deesdesignengineering.com

Gurrola, George

Hm (510) 843-9417, ggurrola@comcast.net

Honey, Stan

Hm phone/fax (650) 328-3428, Wk (650) 961-7825,
Cell (650) 269-3428, stanhoney@msn.com

Richards, Kame

Pineapple Sails, Hm (510) 522-3109, Wk (510) 522-2200,
Fax (510) 522-7700, kame@pineapplesails.com

Sodaro, Robin

Hood Sails, Hm (415) 381-1223, Wk (415) 332-4104,
Cell (415) 279-4104, Fax (415) 332-0943, hoodsails@aol.com

Wijsen, Seadon

seadon.wijsen@northsails.com

Administrative Support: Laura Muñoz

1070 Marina Village Pkwy., #202-G, Alameda, CA 94501
Wk (415) 771-9500, Fax (415) 276-2378, phrf@yra.org

For Multihull ratings, please contact the Bay Area Multihull Association (BAMA) at info@SFBAMA.org, (650) 394-6343, www.SFBAMA.org.



MIKE JOSSELYN

J/105 Fleet #1

San Francisco Bay

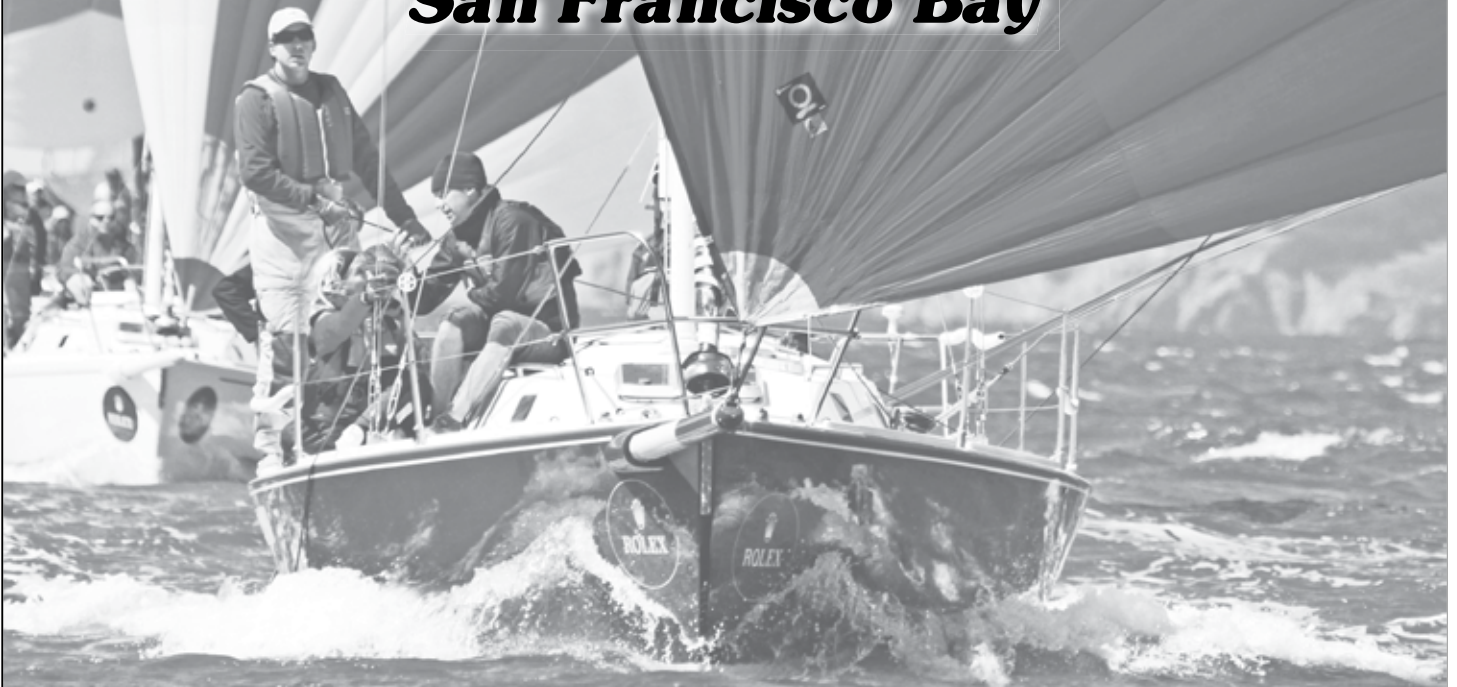

J/105 REGATTAS

From fun to championship* events:

Berkeley YC Midwinters
RegattaPRO Midwinters
Corinthian YC Midwinters
Three Bridge Fiasco
Big Daddy
Spring One Design
Resin Regatta
J/Fest*
Vallejo Race
J/105 Series Stopover
June Invitational
Westpoint Regatta
Bay Bridge Regatta*
Sausalito One Design Invitation*
Summer Keelboat*
Aldo Alessio*
Rolex Big Boat Series*
Leukemia Cup
Great Pumpkin



Be a part of the largest North American J/105 Fleet
www.sfj105.org

FINAL 2017 CALENDAR POSTED AT:
www.sfj105.org

For sales information, go to
www.sailcal.com

License #0E32738

TWIN RIVERS MARINE INSURANCE AGENCY, INC.

"Your Marine Insurance Specialists"

7 Marina Plaza | Antioch, CA 94509 | At the Antioch Marina

Latitude 38° 01' 10" N - Longitude 121° 49' 10" - Buoy 4 Red - On the San Joaquin River

Shop Your Renewal & Save – Flexible Survey Requirements
Broad Navigation Areas • Liveaboards • Classic Yacht Coverage
Agreed Value Policies • Full Spill Liability • Get a Quote Online



Your Twin Rivers Policy Comes With An Agent!



— REPRESENTING —



WWW.BOATINSURANCEONLY.COM • 800.259.5701

WEST COAST | HAWAII | MEXICO | EAST COAST

Commercial Marine Insurance CALL DOUG for a QUOTE

Marinas/Resorts • Yacht Clubs • Dealers/Brokers
Rental Vessels • Yacht B&B • Charter/Tour/Fishing Vessels
Vessel Repair Facilities • Boat Builders • Marine Contractors
Marine Products Manufacturers
Wholesalers/Distributors • Workboats

Doug Rader, Your Commercial Marine Specialist
Direct: 209.334.2858



ALSO OFFERING POLICIES FOR HIGH VALUE YACHTS

Let Gary's knowledge and experience with insuring high value yachts give you the peace of mind that you are looking for. We have the ability to shop the market to offer you the most comprehensive coverage that you desire.

CALL GARY for
YACHT COVERAGES and SERVICES offered



RULES

Latitude 38's Basic Racing Guidelines

Since sailboat racing is a recreational sport, we think the number one rule should be to have fun. Beyond that, some basic guidelines help prevent collisions and ensure that racing is both fun and fair. Below is an outline of the ten basic rules which cover most racing situations. For completeness and total accuracy, refer to *Racing Rules of Sailing 2017-2020*, published by US Sailing. See www.ussailing.org/rules for details.

1. **Port tack keep clear** of starboard tack.



- If boats are on the *same tack*, and overlapped, **the windward boat must keep clear** of the boat to leeward.
- If boats are on the *same tack*, a boat clear astern **must keep clear** of a boat clear ahead.
- When tacking or jibing, keep clear** of boats on a tack.
- Avoid collisions.** If you have the right of way and hit the other boat, causing damage or injury, you both will be penalized.
- Don't obstruct.** Don't make it hard for the 'keep clear' boat to do so. (No hunting allowed.)
- Sail the course** prescribed. You have to round the marks in the directions specified in the Sailing Instructions and can't touch a mark.
- Proper Course** (same tack, within two hull lengths). If the leeward boat came from astern, leeward boat shall not sail above its own proper course during the overlap. (Remember that the windward boat still has to keep clear, even if windward is forced above what it believes is windward's proper course. Leeward still has right of way.)
- Give room at marks and obstructions** to yachts overlapped on the inside, except:
 - When the overlap did not exist before the lead boat reaches the **three-boatlength zone**.
 - When approaching a windward mark on opposite tack.
 - At a starting mark surrounded by navigable water. That is, you don't have to let a barger in at the start except to avoid collision (then protest).
- Acknowledge your fouls and protest those who don't.**

A free rule book comes with US Sailing membership. See www.ussailing.org.



Quality. Innovation. Performance.

Achieving excellence is a team effort. That is why we partner with sailors from around the world, Olympians, leading riggers, and retailers to create innovative, high quality products that never compromise on strength, durability, and performance.

www.neropes.com



Our full service mobile rigging shop travels to your boat, regardless of location. Our first priority is getting you back on the water, **quickly and safely.**

510-681-5815

roguerigger@gmail.com

WWW.ROGUERIGGING.COM

EQUIPMENT REQUIREMENTS FOR ALL IN-THE-BAY YRA RACES

These requirements are for races held within San Francisco Bay. Please note that OYRA races have separate requirements which can be found at www.norcalorc.org/gear.

- 1.1 These Minimum Equipment Requirements establish uniform minimum equipment and training standards for a variety of boats racing in San Francisco Bay under YRA. These regulations do not replace, but rather supplement the requirements of the U.S. Coast Guard, the Racing Rules of Sailing (RRS), the rules of Class Associations, and all applicable rating rules.
- 1.2 The safety of a boat and her crew is the sole and inescapable responsibility of the “person in charge,” as per RRS 46, who shall ensure that the boat is seaworthy and manned by an experienced crew with sufficient ability and experience to face bad weather. S/he shall be satisfied as to the soundness of hull, spars, rigging, sails and all gear. S/he shall ensure that all safety equipment is at all times properly maintained and safely stowed and that the crew knows where it is kept and how it is to be used.
- 1.3 A boat may be inspected at any time by an inspector or measurer of the Organizing Authority. If she does not comply with these regulations her entry may be rejected, or will be liable to disqualification, or such other penalty as may be prescribed by the race protest committee.
- 1.4 All equipment required shall function properly, be regularly checked, cleaned and serviced, and be of a type, size and capacity suitable for the intended use and size of the boat and the size of the crew. This equipment shall be readily accessible while underway and, when not in use, stored in such a way that deterioration is minimized.
- 1.5 A boat’s heavy items such as batteries, stoves, toolboxes, anchors, chain and internal ballast shall be secured.
- 2.1 A boat shall have a manual bilge pump of at least a 10 GPM capacity.
 - 3.1.5 Each crewmember shall have a life jacket intended for small boat sailing or other active boating. Each such life jacket shall be USCG, ISO, or applicable government approved or shall meet the ocean requirement of 3.1.1.
- 3.3.1 A boat racing between sunset and sunrise shall carry navigation lights that meet U. S. Coast Guard or applicable government requirements mounted so that they will not be obscured by the sails nor be located below deck level.
 - 3.4 A boat shall carry fire extinguisher(s) that meets U.S. Coast Guard or applicable government requirements, when applicable.
 - 3.5 A boat shall carry sound-making devices that meets U.S. Coast Guard or applicable government requirements, when applicable.
 - 3.6.4 A boat shall carry U.S. Coast Guard flares meeting day/night requirements not older than the expiration date. Alternately, non-pyrotechnic distress signals (distress flag for day, SOS light for night) which meet USCG requirements may be substituted.
 - 3.7.3 A boat shall have a throwing sock-type heaving line of 50’ (15m) or greater of floating polypropylene line readily accessible to the cockpit.
 - 3.8 A boat shall carry a U.S. Coast Guard-approved Type IV throwable device.
 - 3.9 A boat shall have a VHF radio which may be handheld or fixed mount.
 - 3.11 A boat shall have at least one means to navigate (charts, GPS) which is appropriate for the race area and the characteristics of the boat.
 - 3.19.1 A boat shall have a magnetic compass independent of the boat’s electrical system suitable for steering at sea.
 - 3.23 A boat shall carry one anchor, meeting the anchor manufacturer’s recommendations based on the yacht’s size, with a suitable combination of chain and line.
 - 3.25 A boat shall carry a first aid kit and first aid manual suitable for the likely conditions of the passage and the number of crew aboard.
 - 3.27.2 A boat shall carry one sturdy bucket of at least two gallons (8 liters) capacity with lanyards attached.
 - 4.2 Annually, two-thirds of the boat’s racing crew shall practice man-overboard procedures appropriate for the boat’s size and speed. The practice shall consist of marking and returning to a position on the water, and demonstrating a method of hoisting crewmember back on deck, or other consistent means of reboarding the crewmember.

UNI-TITANIUM®

ULTIMATE PERFORMANCE



Buy With Confidence
Race With Confidence

UK Northern California
 2021 Alaska Packer Pl.
 Alameda, CA 94501
 Tel: 510-523-3966



Boomkicker®

Boom Supports



- The simple choice for boats 14 to 38 feet.
- Eliminates the need for the topping lift along with the chafe, windage, hang-ups and adjustment.
- Simple flexing design (up or down) is lightweight and fast acting with easy installation separate from the vang, fittings included.
- Proven durable and reliable.

Join Over 10,000 Happy Customers!

www.boomkicker.com
(800) 437-7654 • (708) 482-8801

Manufactured in the U.S. by Seoladair Ltd.

TREASURE ISLAND SAILING CENTER
 Launching Point for New Horizons



TISC offers a Full Range of Adult Classes

Sail in the protected waters of Clipper Cove, conveniently located in the middle of the Bay!

Great Boats + New Sails + Professional Instructors = SAFE SUMMER FUN!

Learn to Sail the Right Way

US Sailing Basic Keelboat Certification –
 Introductory rate: \$699 / 4 days over two weekends
Online Course Included



Adult Dinghy – Beginner • Intermediate • Advanced
 \$250 / weekend session

Every Weekend • Wetsuits and Foul Weather gear provided!



Don't Forget...

Sailing Summer Camp for Kids ages 6-18 runs June 6 through August 19.
Generous income-based scholarships available!
 (Under \$70K = 1/2 price / Under \$40k FREE)
 Every reason to get your kids in a sailboat.
 Hurry, we're filling up fast!

See our website for details: www.tisailing.org
 or call: 415-421-2225

SAMSON

MLX

Features & Benefits:

- Can be tapered
- High strength
- Lightweight
- Low stretch
- Samthane-coated core matches the cover

Applications:

- Control Line
- Halyard
- Jib/Genoa Sheet
- Mainsheet
- Spinnaker Sheet

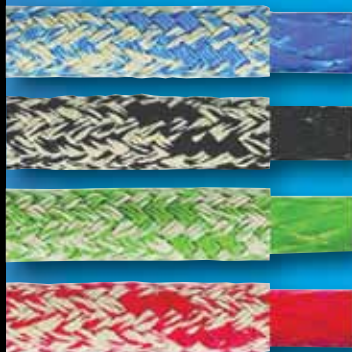

**For Custom Splicing
Services Please
Call or Email
Rigging@Defender.com**

WarpSpeed® II

Features & Benefits:

- Enhanced creep properties
- Excellent abrasion resistance
- Extremely low stretch
- High strength
- Lightweight
- Very low creep

Applications:

- Control Line
- Halyard
- Jib/Genoa Sheet
- Mainsheet
- Spinnaker Guy
- Spinnaker Sheet

Defender®

Your Discount Outfitting Specialist!

800-628-8225 • info@defender.com

www.defender.com

**WE ARE NOT
REQUIRED
TO COLLECT
SALES TAX ON
ORDERS SHIPPED
OUTSIDE OF CT**

**Most Orders
Placed by 4:30pm
Ship Same Day!**



FREE Catalog!

2017 BEER CAN SERIES

The 2017 Beer Can Series Schedule follows. Beer can races are great venues for sailors to learn racing skills, try out new crew, bring the family, socialize, and have fun.

If your club has a beer can series you would like to list here next year, please email your schedule and contact information to colleen@latitude38.com, or fax it to (415) 383-5816, by November 10, 2017.

BALLENA BAY YACHT CLUB

Friday Night Grillers: 3/24, 4/7, 4/21, 5/5, 5/19, 6/2, 6/16, 7/14, 7/28, 8/11, 8/25, 9/8, 9/22.
(510) 865-2511, race@bbyc.org, www.bbyc.org

BAY VIEW BOAT CLUB

Monday Night Madness. Spring: 4/17, 5/1, 5/15, 5/29, 6/12, 6/26 (make-up). Fall: 7/17, 7/31, 8/14, 9/4, 9/18, 9/25 (make-up). Terry Mahoney, (408) 210-0517, tmahoney22@gmail.com, www.bayviewboatclub.org

BENICIA YACHT CLUB

Thursday Nights: 4/6-9/28. Dan Carnahan, (707) 319-5706, race@beniciayachtclub.com, www.beniciayachtclub.com

BERKELEY YACHT CLUB

Every Friday Night: 3/31-9/29. Paul Kamen, (510) 540-7968, pk@well.com, www.berkeleyyc.org

CAL SAILING CLUB

Races year-round, weather and tides permitting. For members only. Check www.cal-sailing.org for specifics.

CORINTHIAN YACHT CLUB

Every Friday Night: 4/14-8/25. Marcus Canestra, (415) 435-4771, racing@cyc.org, www.cyc.org

COYOTE POINT YACHT CLUB

Every Wednesday Night: 4/12-10/4. (650) 347-6730, regatta@cpyc.com, www.cpyc.com

ENCINAL YACHT CLUB

Friday Nights. Spring Twilight Series: 4/7, 4/15, 5/5, 5/19, 6/9. Summer Twilight Series: 7/7, 7/21, 8/4, 8/18, 9/8. Theo Rohr, (510) 205-2451, rearcommodore@encinal.org, www.encinal.org

continued on page 24



AT THE FRONT

No bad air. Nobody to duck. No stack up on the layline.
No compromises. No end to the commitment.

Enter to win a FREE Harken 2017 Ultimate Sailing Calendar by Sharon Green at CalendarDrawing.harken-online.com. Ten calendars will be given away.

HARKEN®

SF BAY CAL 20 FLEET WE INVITE YOU TO JOIN THE FUN



A Cal 20 renaissance is well underway and our numbers are growing. We're competitive and affordable.

COME OUT AND JOIN US!



415.244.2676
info@sfbaycal20.com
www.sfbaycal20.com

Boat & Yacht Insurance

Call NOW for a money saving new quote



Since 1959
www.marinersins.com
 Ins. Lic. #0D36887



**In the Bay Area Contact
 Carolyn Pounds**

(800) 992-4443 ext. 112

(510) 254-3689

carolyn@marinersins.com

Newport Beach, CA San Francisco, CA San Diego, CA Seattle, WA Bradenton, FL

2017 BEER CAN SERIES

continued from page 22

FOLSOM LAKE YACHT CLUB

Wednesday Nights: 5/3-8/30.
Summer Sunset Series: 5/12, 6/16, 7/21, 8/4.
(916) 534-8458, www.flyc.org

GOLDEN GATE YACHT CLUB

"Small Craft Beer" Advisory Series: 5/5, 5/19, 6/2, 6/16, 6/30, 7/14, 7/28, 8/11, 8/25.
Ray Davis, (510) 926-2441,
raceoffice@ggyc.com, www.ggyc.com

ISLAND YACHT CLUB

Friday Nights.
Spring Twilight: 4/14, 4/28, 5/12, 6/2, 6/16.
Summer Twilight: 7/14, 7/28, 8/11, 8/25, 9/15.
John New, (510) 521-2980,
iyrcracing@yahoo.com, www.iyc.org

KONOCTI BAY SAILING CLUB

Old Salts in Retirement,
every Wednesday at noon, year 'round.
www.kbsail.com

LAKE TAHOE WINDJAMMERS YACHT CLUB

Wednesday Nights: May 17-October 11.
David Young, (530) 545-9155,
sierrasailor@gmail.com, www.tahoewindjammers.com

LAKE WASHINGTON SAILING CLUB

Every Thursday Night: May-August.
www.lwsailing.org

LAKE YOSEMITE SAILING ASSOCIATION

Every Thursday Night: May-September.
Dennis Wainwright, (209) 722-1947,
speedyw1955@yahoo.com,
www.lakeyosemitesailing.org

MONTEREY PENINSULA YACHT CLUB

Wednesday Nights: Sunset Series,
late September-March.
race@mpyc.org, www.mpyc.org

OAKLAND YACHT CLUB

Sweet 16 Series.
Every Wednesday Night: 4/26-6/14 & 7/12-8/30.
Jim Hild, (510) 277-4676,
oycracecom@gmail.com,
www.oaklandyachtclub.com

RICHMOND YACHT CLUB

Wednesday Nights: 4/5, 4/19, 4/26, 5/3, 5/17, 5/24,
5/31, 6/7, 6/21, 6/28, 7/5, 7/12, 7/19, 7/26,
8/2, 8/9, 8/16, 8/23, 8/30, 9/6, 9/20, 9/27.
Eric Arens, (510) 841-6022,
saucierimages@comcast.net,
www.richmondyc.org

SANTA CRUZ YACHT CLUB

Wet Wednesdays, every Wednesday Night: 3/15-11/1.
(831) 425-0690, scyc@scyc.org,
www.scyc.org

SAUSALITO YACHT CLUB

Tuesday Nights.
Spring Sunset Series: 4/25, 5/9, 5/23, 6/6, 6/20.
Summer Sunset Series: 7/25, 8/8, 8/22, 9/5, 9/19.
Doug Ford, race@sausalitoyachtclub.org,
www.sausalitoyachtclub.org

SEQUOIA YACHT CLUB

Every Wednesday Night: 4/19-10/4.
Jenny Thompson, (650) 400-7033,
jennyantho@hotmail.com
www.sequoiayc.org



Kings of the Beer Cans. Robert Ruud, his dad Roger, and skipper Chuck Hooper conquered *Latitude 38's* Beer Can Challenge on the Contessa 33 *Warwhoop* on August 8-12, 2016, sailing in a different series for five evenings in a row. (They 'supersized' their feat with races in San Francisco and Berkeley on the weekend.) They plan to attempt the Beer Can Challenge again in 2017, and encourage other sailors to do the same!

2017 BEER CAN SERIES

SIERRA POINT YACHT CLUB

Tuesday Nights: 5/2-8/29.
Quincy Bragg, (650) 291-4061,
racing@sierrapointyc.org, www.sierrapointyc.org

SOUTH BEACH YACHT CLUB

Friday Night Series: 4/21, 4/28, 5/5, 5/19, 5/26,
6/2, 6/16, 6/23, 6/30, 7/21, 7/28, 8/4, 8/18, 8/25.
Mike Satterlund, (408) 839-4150,
rearcommadore@southbeachyachtclub.org,
www.southbeachyachtclub.org

STOCKTON SAILING CLUB

Every Wednesday Night: 6/7-8/30.
(209) 951-5600, regatta16@stocktonsc.org,
www.stocktonsc.org

TAHOE YACHT CLUB

Monday Nights: Laser Series, 5/29-8/28.
Wednesday Nights: Beer Can Series, 5/31-8/30.
Andrew Casci, (530) 581-4700,
gm@tahoeyc.com, www.tahoeyc.com

TIBURON YACHT CLUB

Every Friday Night: 5/26-8/11.
Cam Tuttle, (415) 789-9294,
race@tyc.org, www.tyc.org

VALLEJO YACHT CLUB

Every Wednesday Night: 4/5-9/27.
Dave Nadolne, (925) 580-1499,
fleetcaptainsail@vyc.org,
www.vyc.org



An inventory committed to the very best.

**Hansen Rigging
delivers for
offshore and inshore
race results!**

ONLY THE BEST

Maffioli and Alpha heat-resistant covered pre-stretched race Dyneema SK 78 and SK 99 *in stock*. Tested on our bench for race-winning performance. Buy it and you'll never go back.

Committed to your success!

HANSEN RIGGING

2307 Blanding Ave., Alameda
(510) 521-7027



hansenrig@sbcglobal.net



www.hansenrigging.com

NEW



OPENING PRE-FEEDER

The new Schaefer opening pre-feeders solve many issues on the bow of any racing sailboat. Our two sizes cover boats in all ranges. The 45-06 is our non-adjustable opening pre-feeder with a computer machined finish for a smooth entry. The single pull opening feature allows for quick disengagement. Our 45-07 Grand Prix design allows the flexibility to adjust for various luff tape sizes from #5 through #8.

SCHAEFER
LEGENDARY STRENGTH

508.995.9511
SCHAEFERMARINE.COM

WATERAT SAILING EQUIPMENT

- One design & offshore rudders & shafts ▪
- Dinghy centerboards & rudders ▪
- Custom structural composites ▪

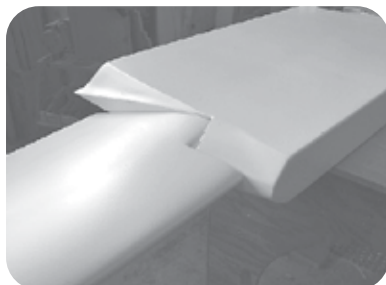
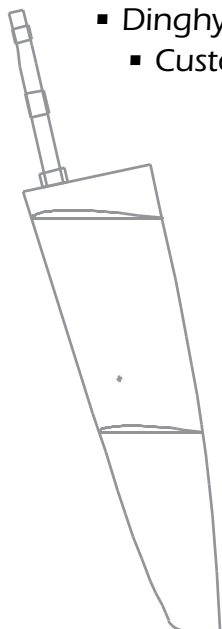

831-768-1520
e-mail: larry@waterat.com
565 McQuaide Dr. La Selva Beach, CA 95076

2017 CARIBBEAN CIRCUIT

QUANTUM KEY WEST RACE WEEK

January 15-20 • Key West, FL

www.keywestraceweek.com

MOUNT GAY ROUND BARBADOS RACE SERIES

January 16-24 • Barbados

www.mountgayrumroundbarbadosrace.com

CONCH REPUBLIC CUP

January 24-February 3 • Key West/Cuba

www.conchrepubliccup.org

GRENADA SAILING WEEK

January 30-February 4 • Grenada

www.grenadasailingweek.com

ANTIGUA SUPERYACHT CHALLENGE

February 2-5 • Antigua

www.superyachtchallengeantigua.com

PINEAPPLE CUP

February 3-10 • Miami to Montego Bay, Jamaica

www.pineapplecup.com

ROUND REDONDA RACE

February 14 • Antigua

www.abma.ag

CUBA CUP

February 17 • Montego Bay to Havana Cuba

www.pineapplecup.com

ANTIGUA 360 RTI RACE

February 18 • Antigua

www.antiguayachtclub.com

RORC CARIBBEAN 600

February 20-24 • Antigua

www.caribbean600.rorc.org

ROLEX SWAN CUP CARIBBEAN

March 1-5 • Virgin Gorda

www.yccs.it/en

ST. MAARTEN HEINEKEN REGATTA

March 2-5 • St. Maarten

Gill Commodore's Cup: March 2

(721) 544-2079, www.heinekenregatta.com

50TH ANNIVERSARY REGATTA BVI

March 6-7 • Virgin Gorda

www.yccs.it/en

LORO PIANA CARIBBEAN SUPERYACHT REGATTA

March 10-13 • BVI

www.loropianacaribbeanbeansuperyachtregatta.com

MIAMI TO HAVANA RACE

March 14-18 • Miami

(386) 437-9400 • www.havanarace.org

ST. BARTHS BUCKET REGATTA

March 16-19 • St. Barths, FWI

(781) 639-0203, www.bucketregatta.com/stbarths

ROUND THE ROCKS RACE

March 23 • St. Thomas, USVI

www.stthomasinternationalregatta.com

ST. THOMAS INTERNATIONAL REGATTA

March 24-26 • St. Thomas, USVI

(340) 642-3204, www.stthomasinternationalregatta.com

BVI SPRING REGATTA AND SAILING FESTIVAL

March 27-April 2 • BVI

(284) 541-6732, www.bvispringregatta.org

LES VOILES DE SAINT BARTH

April 10-15 • St. Barth

(590) 5 90 27 20 64, www.lesvoilesdesaintbarth.com

BEQUIA EASTER REGATTA

April 13-17 • Bequia

www.bequiaregatta.com

ANTIGUA CLASSICS REGATTA

April 19-25 • Antigua Yacht Club

Ph/Fax (268) 460-1799, www.antiguaclassics.com

ST. BARTH WEST INDIES REGATTA

April 28-May 1 • St. Barth

(268) 724-4435, www.westindiesregatta.com

PEARNS POINT ROUND ANTIGUA RACE

April 29 • Antigua

www.abma.ag

ANTIGUA SAILING WEEK

April 29-May 5 • Antigua

(268) 734-6636, www.sailingweek.com

FOXY'S WOODEN BOAT REGATTA

May 2017 • Jost Van Dyke, BVI

(284) 495-9258, www.foxysbar.com/woodenboatregatta

PUERTO RICO HEINEKEN INTERNATIONAL REGATTA

May 2017 • Puerto Rico

(787) 277-5936, www.heinekenregattapr.com

DRY CREEK VINEYARD PRO-AM REGATTA

October 2017 • Bitter End Yacht Club, BVI

(800) 872-2392, www.beyc.com



Spray flying, sails straining, adrenaline flowing.

Here at Sunsail we're ready to send some charterers home with a trophy or two. Our 2017 Regatta season is about to kick off and we are prepared with the most competitive global bareboat fleet to charter.

From the BVI Spring Regatta to the UK's famous Cowes Week, we'll provide all you need to take line honors at the most iconic and exotic regattas the globe has to offer.

2017 Race Schedule

Grenada Sailing Week
January 30 - February 4

St. Maarten Heineken Regatta
March 2 - 5

St. Thomas International Regatta
March 24 - 26

BVI Spring Regatta
March 27 - April 2

Antigua Sailing Week
April 29 - May 5

Tahiti Pearl Regatta
May 23 - 27

Cowes Week
July 29 - August 5

Hamilton Island Race Week
August 19 - 26

Feel the thrill. Put your skills to the test. Call [800.437.7880](tel:800.437.7880) or visit sunsail.com/yacht-racing
Bareboat | Skippered | Flotillas | Sailing Schools



2017 MIDWINTER SERIES

If your organization has a midwinter series you'd like included here next year, email your schedule and contact information to colleen@latitude38.com, or fax it to (415) 383-5816, by November 10, 2017.

BAY VIEW BOAT CLUB

Midwinters. Second Saturday, October-March.
Remaining 2016-2017 season: 1/14, 2/11, 3/11.
Terry Mahoney, (408) 210-0517, tmahoney22@gmail.com,
www.bayviewboatclub.org

BERKELEY YACHT CLUB

Midwinters, remaining 2016-2017 season: 1/14, 1/15, 2/11, 2/12.
Midwinters Champion of Champs: 2/26.
Fall 2017 dates: 11/11, 11/12, 12/9, 12/10.
Bobbi Tosse, (925) 939-9885, bobbi_john@jfcbat.com
Chowder Series, remaining 2016-17 season: 1/1, 1/8, 1/22, 1/29,
2/5, 2/19, 2/26, 3/5, 3/12, 3/19, 3/26.
Fall 2017 dates: 10/1, 10/8, 10/15, 10/22, 10/29, 11/5, 11/19, 11/26,
12/3, 12/17, 12/24, 12/31. Paul Kamen, (510) 540-7968,
pk@well.com, www.berkeleyyc.org

CORINTHIAN YACHT CLUB

Midwinters: 1/21-22, 2/18-19.
Marcus Canestra, (415) 435-4771, racing@cyc.org, www.cyc.org

ELKHORN YACHT CLUB

Frostbite Series: 3/4, 3/18, 4/1.
Chowder Cup Series: 10/28, 11/11, 11/25.
(831) 724-3875, eyc@elkhornyc.com, www.elkhornyc.com

ENCINAL YACHT CLUB

Jack Frost Midwinters, remaining 2016-2017 season:
1/21, 2/25, 3/18. Fall 2017: 11/18.
Theo Rohr, (510) 205-2451,
rearcommadore@encinal.org, www.encinal.org

GOLDEN GATE YACHT CLUB

Midwinters, remaining 2016-2017 season: 1/7, 2/4, 3/4.
Fall 2017: 11/4, 12/2.
Dennis Bush, (510) 703-5779, bush.sailing@gmail.com,
www.ggyc.org

ISLAND YACHT CLUB

Midwinters, remaining 2016-2017 season: 1/8, 2/12, 3/12.
Fall 2017: 11/12, 12/10. John New, (510) 521-2980,
iycracing@yahoo.com, www.iyc.org

LAKE MERRITT SAILING CLUB

Robinson Memorial Midwinters, remaining 2016-2017 season: 1/15,
2/11, 3/12. Peggy Darnall, (510) 836-1805.

MONTEREY PENINSULA YACHT CLUB

Perry Cup Midwinters; remaining 2016-2017 season: 1/7, 2/4.
race@mpyc.org, www.mpyc.org



TRANS TAHOE
JUNE 23-25, 2017

TAHOE YACHT CLUB

JOIN US FOR FUN ON THE LAKE
TRANS TAHOE REGATTA
FOR KEELBOATS AND MULTIHULLS
(FLEETS INVITED)

VISIT US AT THE TAHOE YACHT CLUB
WWW.TAHOEYC.COM

2017 MIDWINTER SERIES

OAKLAND YACHT CLUB

Sunday Brunch Series: 1/15, 1/22, 1/29, 2/19, 2/26, 3/19, 3/26.
Jim Hild, (510) 277-4676,
oyracecom@gmail.com, www.oaklandyachtclub.com

REGATTA PRO

Winter One Design Series, remaining 2016-2017 season: 1/14, 2/11.
Fall 2017: 11/11, 12/9.
Jeff Zarwell, (415) 595-8364, jzarwell@regattapro.com,
info@regattapro.com, www.regattapro.com

RICHMOND YACHT CLUB

Opti Midwinters, remaining 2016-2017 season: 1/7, 2/4, 3/4.
Fall 2017: 12/2. Dan Brandt, dan.higherfastervmg@gmail.com
Small Boat Midwinters, remaining 2016-2017 season: 1/8, 2/5, 3/5.
Fall 2017: 12/3.
Nancy Pettengill, (510) 234-1253,
nancyepettengill@comcast.net, www.richmondyc.org

SANTA CRUZ YACHT CLUB

Midwinters, remaining 2016-2017 season: 1/21, 2/18, 3/18.
Fall 2017: 11/18, 12/16.
scyc@scyc.org, www.scyc.org

SANTA ROSA SAILING CLUB

Spring Lake Winter Series, remaining 2016-2017 season:
1/22, 2/19, 3/19, 4/9. Fall 2017: 10/22, 11/12, 12/10.
www.santarosasailingclub.org

SAUSALITO YACHT CLUB

Midwinters, remaining 2016-2017 season: 1/8, 2/5, 3/5.
Fall 2017: 11/5, 12/3.
Doug Ford, race@sausalityachtclub.org,
www.sausalitoyc.org

SEQUOIA YACHT CLUB

Winter Series, remaining 2016-2017 season: 1/7, 2/4,
3/18 (St. Patrick's Day Race). Fall 2017: 11/4, 12/2.
Redwood Cup, remaining 2016-2017 season: 1/21, 2/25, 3/11.
Fall 2017: 11/18, 12/9.
Jenny Thompson, (650) 400-7033, jennyantho@hotmail.com,
www.sequoiayc.org

SOUTH BEACH YACHT CLUB

Island Fever Series, remaining 2016-2017 season:
1/28, 2/25, 3/18. Fall 2017: 11/18, 12/16.
Mike Satterlund, (408) 839-4131,
rearcommadore@southbeachyachtclub.org,
www.southbeachyachtclub.org

TIBURON YACHT CLUB

Midwinters: 1/7, 2/4, 3/4.
Cam Tuttle, (415) 789-9294, race@tyc.org, www.tyc.org

VALLEJO YACHT CLUB

Tiny Robbins Midwinters, remaining 2016-2017 season:
1/21, 2/18, 3/18.
Hugo Knef, (707) 337-1446, hugoknef@gmail.com, www.vyc.org

AIRX
SPINNAKER FABRICS

watt&sea

PLASTIMO

YALE CORDAGE

Italwinch
BY ORVEA

**For The Best In
Marine Hardware
& Sailmaking
Products.**

Since 1917.

BAINBRIDGE
INTERNATIONAL
15242 Transistor Lane,
Huntington Beach, CA 92649
Tel: 800.433.0101
www.bainbridgeintusa.com



2017 RACE DECK SCHEDULE

46th Annual Manuel Fagundes

SEAWEED SOUP REGATTA

January 7, February 4, March 4

"SMALL CRAFT BEER" ADVISORY SERIES

Will feature a different small craft beer after each race!

May 5, May 19

June 2, June 16, June 30

July 14, July 28

August 11, August 25

INAUGURAL RAINBOW REGATTA

Co-hosted by the Barbary Coast Boat Club

June 17

47th Annual Manuel Fagundes

SEAWEED SOUP REGATTA

November 4 & December 2

Join us for these fun-filled races, and enjoy the greatest view at the friendliest club on the Bay!

GOLDEN GATE YACHT CLUB

1 Yacht Road, San Francisco, CA 94123

(415) 346-2628

www.ggyc.org

2017 SHORTHANDED CIRCUIT

The OYRA Series and YRA Weekend Regattas have Shorthanded Divisions. Go to www.yra.org for details. Sequoia YC has a shorthanded series for local racers. The Singlehanded Sailing Society hosts seven local regattas and the Singlehanded TransPac in even years.

Jan. 28	Three Bridge Fiasco, SSS
Feb. 11	Single/Doublehanded #1, SeqYC
March 4	Single/Doublehanded #2, SeqYC
March 11	Rites of Spring Race, OYC
March 11	Doublehanded Long Distance, SSC
March 18	Doublehanded Farallones, BAMA
March 25	Corinthian Race, SSS
April 1	Single/Doublehanded #3, SeqYC
April 8	Doublehanded Lightship Race, IYC
April 15	Round the Rocks, SSS
April 22	YRA OYRA Lightship
May 6-7	YRA Great Vallejo Race
May 13	YRA OYRA Duxship
May 20	Singlehanded Farallones Race, SSS
May 20	Single/Doublehanded #4, SeqYC
May 26	Spinnaker Cup to Monterey, SFYC/MPYC
June 3	YRA OYRA RC's Choice
June 17	YRA OYRA Farallones Race
July 1	YRA OYRA Half Moon Bay Race
July 8	Jack and Jill Race, SSC
July 15	YRA Westpoint Regatta
July 23	Doublehanded Races, LTWYC
July 29-30	YRA Second Half Opener
August 12-13	YRA OYRA Drake's Bay Race
August 20	Gracie & George Race, EYC
August 20	Singlehanded Races, LTWYC
August 26	YRA OYRA RC's Choice
August 26	Single/Doublehanded #5, SeqYC
Sept. 9	YRA OYRA Jr. Waterhouse
Sept. 16	Half Moon Bay Race, SSS
Sept. 23	Jack and Jill Regatta, SCYC
Sept. 30	Shorthanded Races, TYC
Sept. 30-Oct. 1	YRA Season Closer
Oct. 21-22	Vallejo 1-2, SSS
November 5	Jack & Jill + 1 Race (Triplehanded), IYC

Use the Autopilot Favored by Singlehanded Racers

**For over 40 Years, ALPHA PILOTS
Have Delivered the Highest Performance,
Reliability and Low Power Consumption
These Competitors Demand!**



Photo by Robbie Gabriel

Overall Winner 2012 Singlehanded TransPac

Jim Quanci, after placing 1st Overall in the 2012 Singlehanded TransPac in his Cal 40 *Green Buffalo* says:

"Thirteen days from San Francisco to Hawaii alone, 10 of those days flying the spinnaker in winds up to 32 knots without a round up or a wrap. My Alpha Spectra autopilot drove the whole way – and then drove the boat another 16 days taking us home. What more can one ask for? I just love my Alpha Spectra autopilot."

Why buy an Alpha Autopilot? We'll make your boating more fun!

A WORLD CLASS PRODUCT PROUDLY BUILT IN THE USA

ALPHA MARINE SYSTEMS, INC., 6809 96th Avenue SE, Mercer Island, WA 98040 • (800) 257-4225 (206) 275-1200
email sales@alphamarinesystems.com Visit our website www.alphamarinesystems.com



HEAD SOUTH FOR RACING IN 2017

Join Us at the Sequoia Yacht Club



Featuring:

**WESTPOINT REGATTA
2017**

A YRA Weekend Regatta!

South Bay Championship
Hannig Cup
Moonlight Marathon
Barth Race

Redwood Cup Series
Winter Series
Summer Series
Single/Doublehanded Series
Wednesday Night
Sunset Series

Schedules and information: www.sequoiayc.org

2017 FLEET SCHEDULES

Sailing Instructions for all YRA regattas and races will be posted on www.jibeset.net. Sailing Instructions are available one week prior to the start of each race.

Racers entering an OYRA ocean race or OYRA ocean series must comply with the specific OYRA Minimum Equipment Requirements, including the requirement for a 406 EPIRB or PLB. No later than the Thursday before EACH race, sailors must complete the online Boat and Crew Registration form through www.jibeset.net. Please refer to <http://yra.org/yra-racing/ocean-safety/> for more information on ocean racing requirements.



DIMENSION-POLYANT

The Sailcloth Producer

sprinzandspinz.de

IN-HOUSE MANUFACTURING In Germany and USA
QUALITY AND INNOVATION Continuous research and adherence to the highest standards
RELIABILITY World-wide, Sailors and Sailmakers trust in DIMENSION-POLYANT.



© Guy Newell

SICEN

DIMENSION-POLYANT GmbH • Speefeld 7 • 47906 Kempen • Germany • Tel. +49 21 52 8910 • dimension-polyant.com

Single Race Entries are due by 5:00 p.m. the Monday prior to the race. Entries received after 5:00 p.m. Monday may incur a \$35 late fee. Entries are not accepted after 5:00 p.m. the Thursday prior to the race.

YRA Series

For PHRF, Sportboat and One Design. Notices of Race for all YRA Series can be found on the YRA website, www.yra.org.

- May 20: YRA Series #1
- June 24: YRA Series #2
- July 22: YRA Series #3
- August 5: YRA Series #4

OYRA Series

- April 22: Lightship Race
- May 13: Duxship Race
- June 3: Race Committee's Course Choice
- June 17: Farallones Race
- July 1: Half Moon Bay Race
- August 12-13: Drake's Bay Race
- August 26: Race Committee's Course Choice
- September 9: Junior Waterhouse

2017 FLEET SCHEDULES

CBRA Series

May 6: CBRA #1
June 10: CBRA #2
August 6: CBRA #3
September 2: CBRA #4
September 23: CBRA #5

YRA Weekend Regattas

May 6-7: Season Opener:
The Great Vallejo Race
July 15: Westpoint Regatta
July 29-30: Second Half Opener
September 30-
October 1: Season Closer

SSS

See ad on page 69.

January 28: Three Bridge Fiasco
March 25: Corinthian Race
April 15: Round the Rocks
May 20: Singlehanded Farallones
August 12-13: Drake's Bay Race
September 16: Half Moon Bay Race
October 21-22: Vallejo 1-2

Notices of Race for all YRA Series can be found on the YRA website, www.yra.org.



ERIK SIMONSON / WWW.PRESSURE-DROP.US

Put the *smooth* back in sailing

with these products from Team McLube

SAILKOTE

FOR EVERYTHING THAT SLIDES

Repels water, dirt, salt, and contaminants. Use on sliding hatches, sail tracks, sails, battens, telltales, slider cars and more.

HULLKOTE

FOR EVERYTHING THAT SHINES

High-gloss finish that cleans, polishes, and protects. Use on fiberglass, metal, plexiglass, and painted surfaces.

ANTIFOUL ALTERNATIVE

FOR EVERYTHING BELOW THE WATERLINE

Helps prevent below-the-waterline marine growth and slime from adhering for weeks. Use on hulls, outdrives, and propellers.

ONEDROP

FOR EVERYTHING THAT ROLLS

Repels salt, dirt, and other deposits. Use on ball bearing traveler cars and battcars.



Team
McLube

Learn more at: WWW.MCLUBEMARINE.COM



SEND YOUR BEST SHOT!

2017 Cover Contest... All Year Long

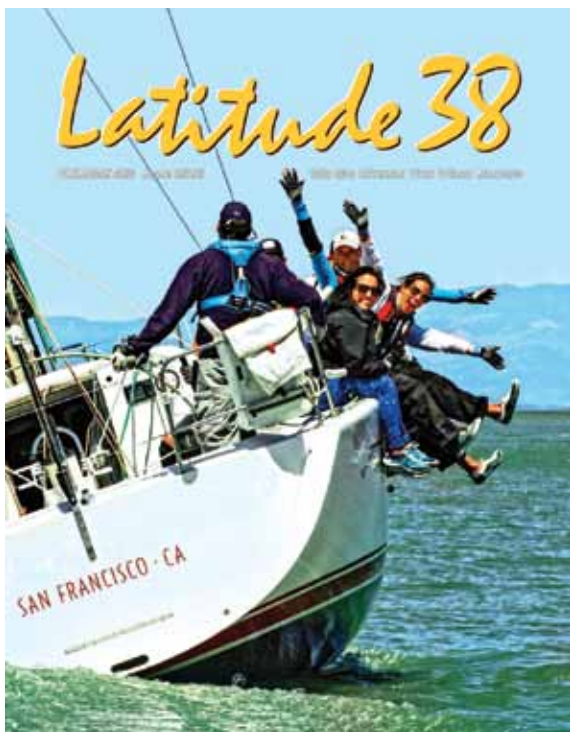

Win a Prize • Tell Your Story

Send your best race, crew,
or boat photo to:
general@latitude38.com

Frequent Winners – Grand Prize 2018 Cover!



DESCRIPTION OF MARKS

Buoys of Berkeley Circle: BOC, COC, EOC, FOC, GOC, XOC

YRA Mark XOC has been designated the *Bob Klein Memorial Buoy* by the YRA Board of Directors. Maintenance of this buoy is funded by the Richmond Yacht Club Foundation.

A: Yellow sphere "A" Outer Buoy ~ St. Francis Yacht Club

D: G "3" Fl G 4s 15 ft on Olympic Circle

K: Temporary YC buoy .3 nm west of YRA 4 and in line with YRA 12

L: Temporary YC buoy .31 nm west of windmill in line with YRA 4

N: Daymark "2" Fl R on channel east of Sausalito

X: Yellow sphere "X" ~ Golden Gate Yacht Club

1: Red Rock Island

2: Alcatraz Island

3: Farallones Light (ocean)

4: Temporary YC buoy WSW of Pt. Knox

5: Temporary YC buoy approx. .6 nm SW of Alcatraz

6: Yellow Column "M" 200 yds. north of Ft. Mason Docks

7: R "2" Fl 6s 1 nm NW of Treasure Island

8: R "4" Fl 4s Horn 1 nm east of Pt. Blunt

9: Temp. YC buoy .5 nm ESE of west end of Berkeley Pier ruins 1 nm ENE of YRA 10

10: Temporary YC buoy approx. .6 nm ESE of west end of Berkeley Pier ruins

11: Temporary YC buoy 1.5 nm east of Treasure Island

12: G "1" Fl G 4s Little Harding Rock

13: Crissy Field Buoy

14: Southampton Shoals

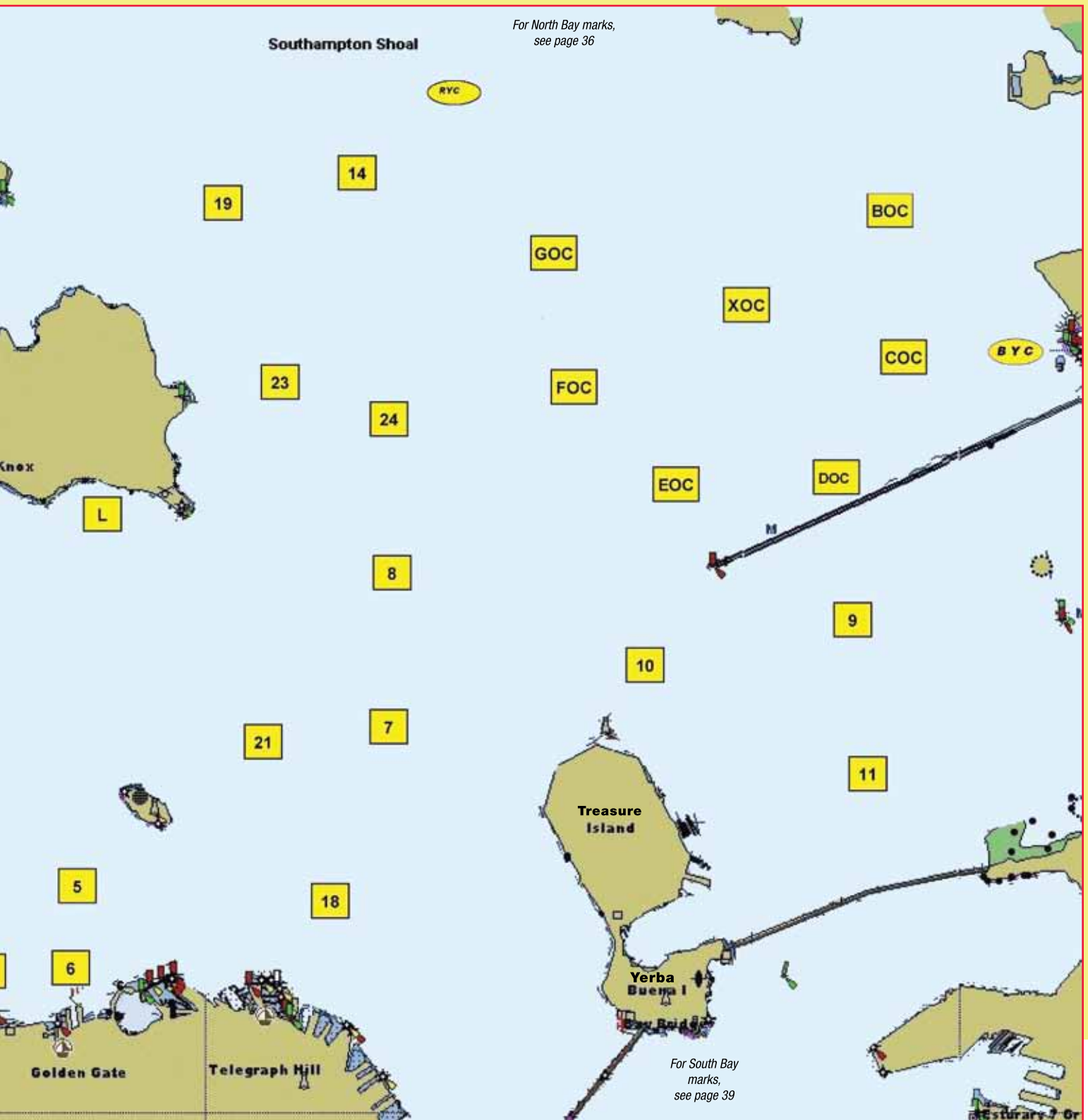

For North Bay marks,
see page 36

For South Bay
marks,
see page 39

- 15: Temporary YC buoy approx. .5 nm east of Yellow Bluff (Sausalito vicinity)
- 16: Yellow Column "C" .2 nm east of Fort Point "Blackaller"
YRA Mark 16 has been designated the *Thomas D. Blackaller Jr. Memorial Buoy* by the YRA Board of Directors. The maintenance of this buoy will be funded by the Thomas D. Blackaller Jr. Fund.
- 17: RG "HR" FI (2+1) R 6s, Harding Rock
- 18: RG "BR" FI (2+1) G 6s bell, Blossom Rock
- 19: R "8" FI R 2.5s approx. 1.5 nm east of Pt. Bluff
- 21: G "1" FI G 6s .65 nm NE of Alcatraz
- 23: RW "A" Mo (A) east of Angel Island
- 24: R "6" FI R 4s bell, 1.1 nm east of Quarry Pt.
- BYC: Yellow column "BYC" east of COC

- CM2: R "2" FI R 6s on outer end of Corte Madera Channel
- NO: North Approach Buoy FI Y 4s to San Francisco Channel (ocean)
- SO: South Approach Buoy FI Y 4s to San Francisco Channel (ocean)
- NBAY: Temporary YC buoy approx. .6 nm NE of Tiburon YC clubhouse
- NG7: G "7" FI G 2.5s approx. .45 nm SE of Red Rock
- NR12: R "12" FI R 4s approx. 1.3 nm south of Richmond-SR Bridge main channel
- NR14: R "14" FI R 4s approx. .28 nm south of Richmond-SR Bridge main channel
- PB: Point Bonita RG FI (2+1) R 6s bell (ocean)
- RYC: Yellow column "RYC" on southern edge of Southampton Shoals
- SF: Center Channel Buoy RW "SF", strobe FI 2.5s whistle on SF Channel (ocean)
- TYC: Privately-maintained white mark "TYC" off south entrance to Paradise Cay

NORTH BAY MARKS

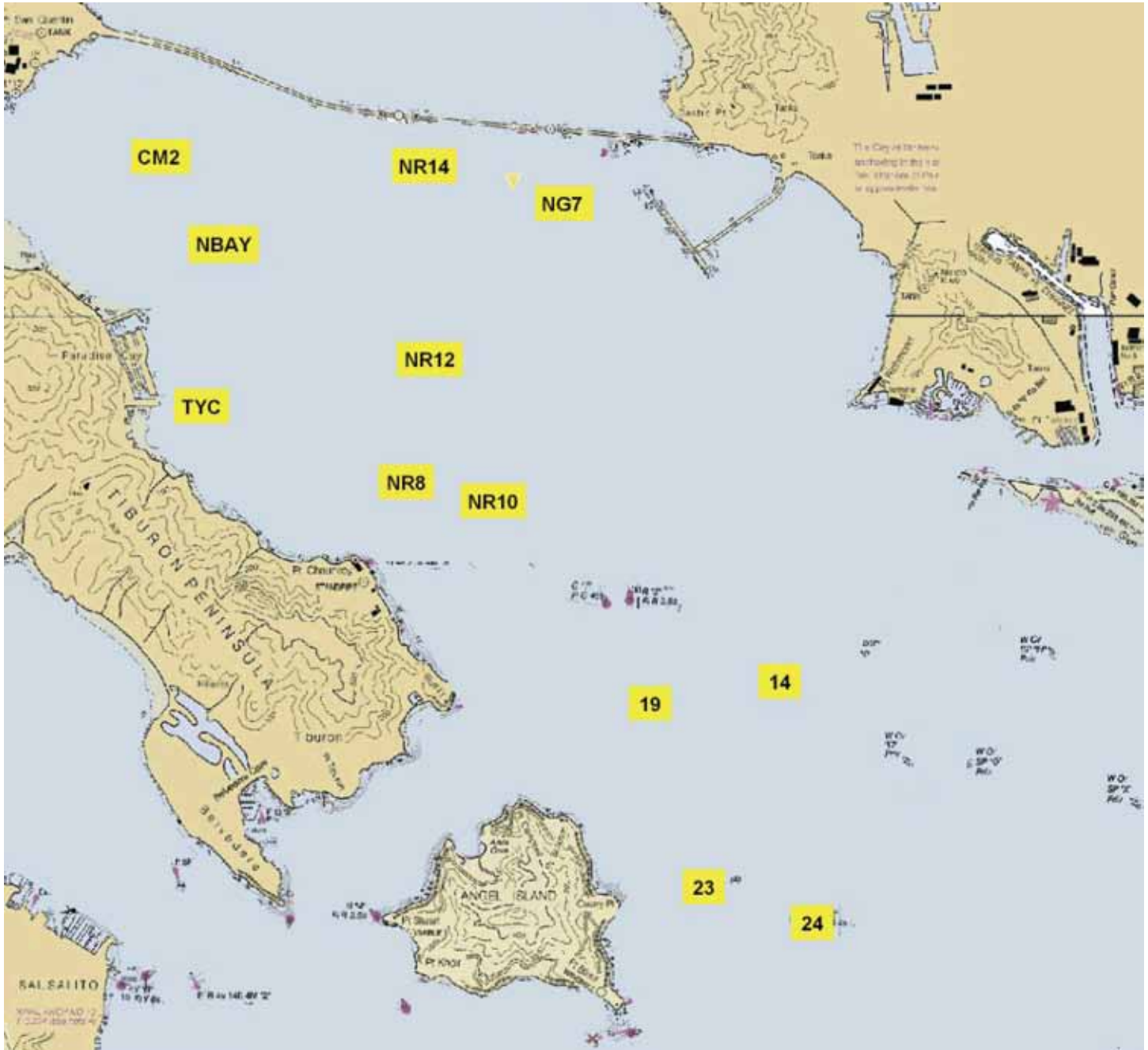

DESCRIPTION OF MARKS

- 14: Southampton Shoals
- 19: R "8" FI R 2.5s approx. 1.5 nm east of Pt. Bluff
- 23: RW "A" Mo (A) east of Angel Island
- 24: R "6" FI R 4s Bell, 1.1 nm east of Quarry Pt.
- CM2: R "2" FI R 6s on outer end of Corte Madera Channel
- NO: North Approach Buoy FI Y 4s to San Francisco Channel (ocean)
- SO: South Approach Buoy FI Y 4s to San Francisco Channel (ocean)
- NBAY: Temp YC buoy approx. .6 nm NE of Tiburon YC clubhouse
- NG7: G "7" FI G 2.5s approx. .45 nm SE of Red Rock
- NR12: R "12" FI R 4s approx. 1.3 nm south of Richmond-San Rafael Bridge main channel
- NR14: R "14" FI R 4s approx. .28 nm south of Richmond-San Rafael Bridge main channel
- SF: Center Channel Buoy RW "SF", strobe FI 2.5s whistle, on San Francisco Channel (ocean)
- TYC: Privately maintained white mark "TYC" off south entrance to Paradise Cay



CAROLE GUNN

DEFINITIONS FOR YRA RACING AREAS

The following racing areas have been defined by the YRA for the purposes of describing the general geographical location and the marks that may be used in a YRA race. Please refer to the individual Sailing Instructions for each YRA race for the exact courses. Temporary marks may be used instead of, or in conjunction with, the described marks in any of these YRA Racing Areas. Sailing Instructions will be available on the YRA website at www.yra.org approximately one week prior to the start of a YRA race.

BERKELEY CIRCLE (OC) RACING AREA

See pages 34-35.

Includes Marks BOC, COC, DOC, EOC, FOC, GOC, XOC, 8, 12, 15, 17.

CITYFRONT RACING AREA

See pages 34-35.

Includes Marks A, X, 6, 16, 17, 18, 21.

KNOX RACING AREA

See pages 34-35.

Includes Marks K, L, N, 4, 12, 15, 21, 23.

NORTH BAY (NB) RACING AREA

See page 36.

Includes Marks CM2, NG7, NR8, NR10, NR12, NR14, TYC, 14.

SOUTH BAY (SB) ALAMEDA SIDE RACING AREA

See page 39.

Races held in this sailing area will use temporary marks in the vicinity of NAS2.

SOUTH BAY (SB) SF SIDE RACING AREA

See page 39.

Includes Marks AS1, NAS2, W1, XS1, 31, 34, 37.

SOUTHAMPTON SHOALS (SH) RACING AREA

See pages 34-35.

Includes Marks N, 7, 12, 14, 19, 21.

TREASURE ISLAND (TI) RACING AREA

See pages 34-35.

Includes Marks EOC, 2, 7, 9, 10, 17, 18, 21.

2017 Wheeler Regatta April 1 & 2 (No Foolin'!)



Saturday: Buoy racing for monohulls and multihulls
Deep water courses

Sunday: Pursuit Race

Berkeley Yacht Club

Details at:

www.Berkeleyyc.org

Contact: Bobbi Tosse

Bobbi@jfcbat.com • (925) 939-9885

The San Francisco Yacht Club and Monterey Peninsula Yacht Club

announce the
**20th Annual Spinnaker Cup
MEMORIAL
DAY
WEEKEND!**

San Francisco to Monterey

Start in the Knox Race Area.
Finish off Municipal Wharf #2 in Monterey.

The Notice of Race
will be available at: www.sfyc.org and www.mpyc.org

For further information please contact:
Race Office, SFYC 415.789.5647 race@sfyc.org
Rear Commodore, MPYC 831.372.9686 race@mpyc.org

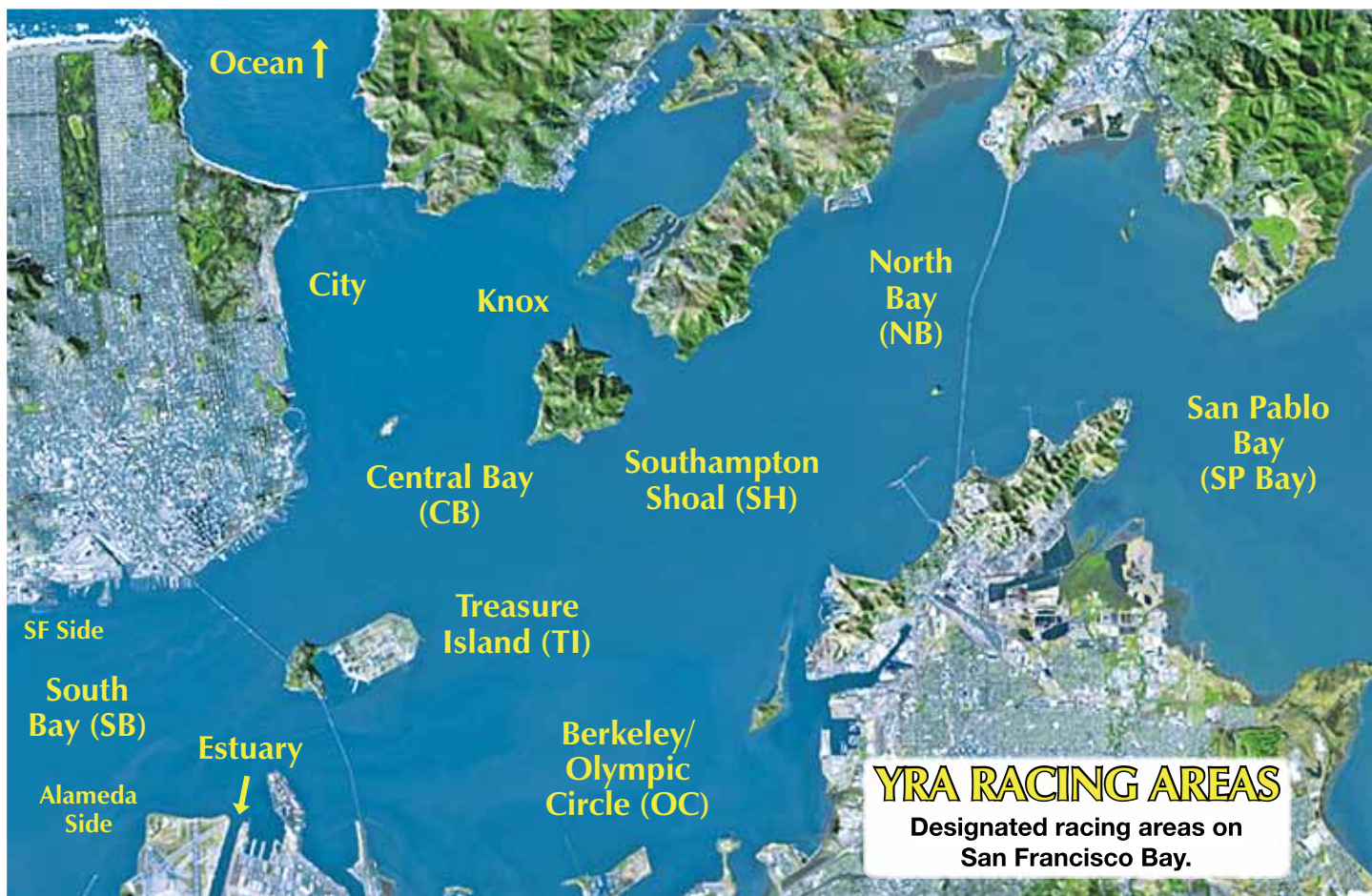

2017 RACE SCHEDULE

We offer excellent racing off the Marin Headlands and around San Francisco Bay. Our bar and galley are open for after-race bragging or analysis. In our 75th anniversary year we'll be celebrating our club's 'founding by youth, benefiting youth!'

www.sausalitoyachtclub.org/racing

- SYC Chili Midwinter Series, the first Sunday of the month; January 8, February 5, March 5, November 5, December 3.
- SYC / RegattaPRO Invitational, the second Saturday of the month, January 14, February 11, November 11, December 9. Keep your crew's skills sharp through the winter.
- Jaws Regatta, March 25. A pursuit race that starts and finishes off the club deck with a 'Bay Tour' course. Includes a predicted log division for powerboats.
- Classic Boat Invitational Series, April 8, August 19, September 9. Birds, Bears, Knarrs, Folkboats and more!
- Twin Island Series, April 29, July 15, October 14. Choose your route around Alcatraz and Angel Island.
- Spring Sunset Series, April 25, May 9, May 23, June 6, June 20.
- Rear Commodore's Race, June 24. Downwind to Vallejo Yacht Club with a party and dinner to round off the day.
- PICYA Lipton Cup, July 8. We're proud to host this inter-club event.
- J/105 Fleet 1 Regatta, July 22 – 23.
- Summer Sunset Series, July 25, August 8, August 22, September 5. Enjoy long summer evenings with some racing and a BBQ after.
- Women Skippers Regatta, August 26. This event includes a skippers' breakfast and briefing, racing and post-race party with additional trophies for all-women crews.

SOUTH BAY MARKS



DESCRIPTION OF MARKS

- | | |
|---|--|
| AS1: Yellow sphere approx. .25 nm east of BVBC | 31: Temporary YC buoy approx. 1.2 nm SE of Mission Rock Terminal |
| NAS2: NAS Alameda Channel Mark "R2" FI R 4s | 33: Red buoy "4" FI R 4s, Oakland Inner Harbor Entrance Channel |
| SC1: Red & green buoy "SC" FI G (2+1) approx. 1 nm ENE of Mission Rock Terminal | 34: Red buoy "2" FI R 2s approx. .5 nm east of Potrero Point |
| W1: Temporary YC buoy approx. 1 nm east of Army St. Terminal | 35: Green daymarker "3" FI G 2.5s, Alameda NAS Entrance Channel |
| XS1: Temporary YC buoy approx. halfway between 31 & AS1 | 36: Red daymarker "4" FI R 4s, Alameda NAS Entrance Channel |
| | 37: Green buoy "5" FI G 4s approx. 1 nm SSE of Army St. Terminal |

HELPFUL INFO FOR FILLING OUT AN NCPHRF APPLICATION

Getting a PHRF rating for your boat is one of the easiest ways to get involved in the myriad forms of Bay Area racing. If you have a well-known sailboat, it's likely the YRA already has a rating number on file for your boat type. However, many boats have been modified or may have different sail configurations affecting their speed. For this reason, all boats need their measurements submitted to the YRA in order to get a rating certificate. To make it easier, the YRA has prepared the following instructions to help you fill out the NCPHRF rating application on page 49.

For unmodified class boats, common measurements for items such as I, J, P, and E, as well as ballast and displacement, can be found online, in sales brochures, in class rules, or from your sailmaker. However, if you have a modified or non-class boat, or cannot find all the required information for your boat, the following guidelines can help walk you through the required measurements.

If you have a current or expired certificate and need to make changes to your boat's configuration, please contact the YRA office to discuss your changes and what forms may be necessary. Any other questions please contact the YRA office at (415) 771-9500 or via email at info@yra.org.

SAIL NUMBER

This should be a number that the YRA office has assigned to your boat. Please call the YRA office for more information. Sail Prefix is a country code. This space can be blank or it might say USA or IRL.

CLASS/TYPE

We are looking for the type of boat you have – like a Cal 20 or Islander 36. If your boat is custom-made or one of a kind, please indicate so. If it was designed under some rule, please tell us what rule; e.g., 6-meter, IOR 1/4-ton, etc. In this case, if you have any measurement certificate, no matter how old, please include a copy of it with your application for rating.

ONE DESIGN RATING

Refer to the NCPHRF Rules (www.yra.org) to find out if this applies to you. It is anticipated that other members in your class who know and understand your rules and limitations, as modified by Section V, will monitor the OD ratings.

RIG AND SAIL MEASUREMENTS

What is the source of the information provided? We are looking for where you obtained the information on your certificate. Please indicate by circling which sources apply.

FORETRIANGLE

- I Vertical distance from upper point of 'I' to lower point of 'I'
Upper point of 'I' is the highest of:
 1. Intersection of mast and highest jibstay.
 2. Highest sheave for jib halyard drawn horizontal to mast.Lower point of 'I' is the sheerline abreast the mast (not the cabin top).
The sheerline is the intersection of the deck and the hull.
- J Horizontal distance from mast to where the forward-most jibstay intersects the deck, or jib tack. Note that 'JC' is no longer on this form.

LARGEST HEADSAIL

Largest Headsail percent is $LP/J \times 100$. The LP (Luff Perpendicular) of your jibs is determined by measuring the distance from the clew to the nearest point on the luff. This is done by holding the zero end of a tape measure at the clew (defined as the intersection of the leech and the foot), removing the wrinkles from the area to be measured, and swinging an arc up and down the luff, recording the minimum distance, then dividing by J and multiplying by 100. For example, suppose you measure an LP of 15.5 feet on your biggest headsail, and your J is 10 feet. Your largest headsail is $15.5/10 \times 100 = 155\%$, which happens to be the largest non-penalty headsail allowed under PHRF for a 10-ft J. Your sailmaker is also a source of information on sail dimensions.

SPL = Spinnaker Pole Length

Spinnaker Pole Length is the length of the spinnaker pole when set in position on the mast; measured from the front face of the mast to the extreme outboard end of the pole. Please note the distinction between a whisker pole and a spinnaker pole: A whisker pole may be used to pole out any jib (but may NOT attach to any type of spinnaker), may be of any length, and may be adjustable. Information on your whisker pole is not required by PHRF, and should not be used as an answer for the spinnaker pole length, as it will often draw an unnecessary penalty.

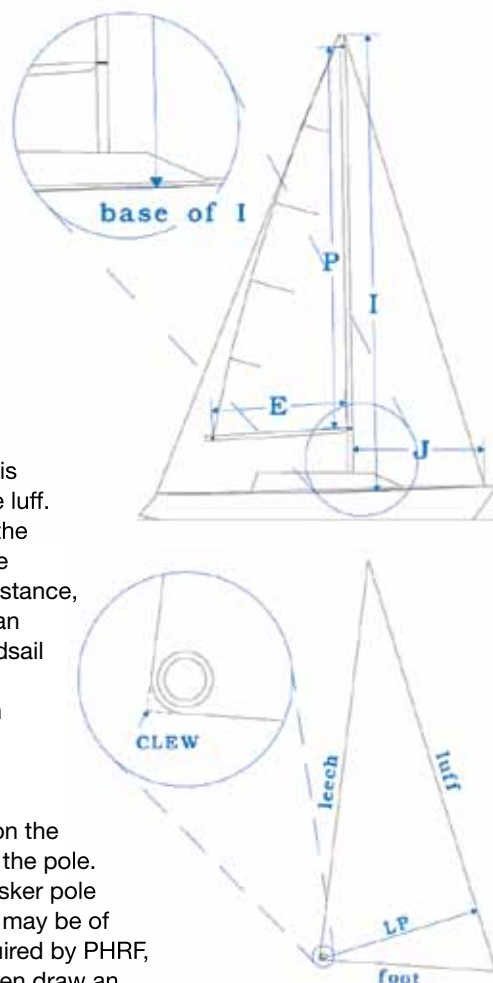

continued on page 42



2017

OYRA Series

The Lightship Race

The One-Way to Half Moon Bay Race

The Duxship Race

The Jr Waterhouse Race

The Drakes Bay Weekend

The Full Crew Farallones Race

+ 2 Race Committee's Choice Races

The YRA ocean racing series features 9 races on and around the Gulf of the Farallones. Divisions are available for full crewed boats, single and double handed boats and multihulls. Racers can sign up for the entire series or enter an individual races.

You can enter the races, view the Notice of Race, and download the Sailing Instructions for the races at www.jibeset.net

Save the Date: Trophies and Series Championships for OYRA Series races will be awarded on November 21, 2017 at the Berkeley Yacht Club.

HELPFUL INFO FOR FILLING OUT AN NCPHRF APPLICATION

continued from page 40

ISP ('I' for the spinnaker)

ISP = spinnaker hoist. Measured from the underside of the spinnaker halyard, when drawn horizontally forward from mast, to the level of the sheerline abreast the mast. The sheerline is the intersection of the deck and the hull.

Note: In some cases, 'I' and 'ISP' are the same. If your spinnaker halyard exits the mast above the upper point of 'I' as described above, then your 'ISP' will be greater than 'I'.

JSP (for boats with sprits and asymmetric spinnakers only)

JSP = spinnaker 'J' horizontal distance from mast to the forward most attachment point for the spinnaker tack.

If this location is adjustable, as with an adjustable bow pole, then measure with the bow pole fully extended on centerline.

TYPE OF RIG

Sloops come in two varieties: 'masthead,' where the forestay goes to the top of the mast; and 'fractional,' where the forestay is anchored to the mast somewhere below the top of the mast. Other types of rigs include ketch, yawl, cutter or catboat.

MAST MATERIAL

What is your mast made of? Common materials are aluminum, wood, carbon, fiberglass, and 'other.'

STANDING RIGGING MATERIAL

What material are your shrouds made of? In part, we are looking for boats that have changed their standing rigging.

continued on page 44

The Konocti Bay Sailing Club Presents

33rd Annual

Konocti Cup

~~~ Now Includes ~~~  
A Non-Spinnaker Division

## Saturday, April 29

26 or 13 mile race for PHRF,  
one designs and multihulls

## Sunday, April 30

Awards Brunch  
One ticket included with registration

Experience our classic regatta on  
beautiful Clear Lake surrounded by  
vineyard covered hills with magnificent views  
of 3200 foot Mt. Konocti



Register at <http://www.kbsail.org/>

Bring the family.

Info at <http://www.lakecounty.com/>



One Race Each Month:  
May, June, July & August  
2 South Bay Races, 2 Central Bay Races

The YRA Series consists of 8 races over 4 days, spread out over the late spring and summer. The series is open to boats with PHRF rating certificates, and to One-Design fleets. One-Design fleets need a minimum of 5 boats to race as a class.

Racers can sign up for the complete series or for an individual race. Enter the races, view the Notice of Race, and download the Sailing Instructions for the races at [www.jibeset.net](http://www.jibeset.net).

Save the Date: Trophies and Series Championships for YRA Series Races will be awarded on November 21, 2017 at the Berkeley Yacht Club.

# HELPFUL INFO FOR FILLING OUT AN NCPHRF APPLICATION

continued from page 42

## MAINSAIL

P = Mainsail Hoist (distance between bands)

E = Mainsail Foot (distance from aft edge of mast to the inner edge of the band on the boom)

HB = The total width of the top of the sail from the front of the luff rope to the top aft corner.

MGU and MGM

MGU (Main Girth Upper) and MGM (Main Girth Middle) are girths measured on your mainsail.

These girths measure the width of mainsails one-quarter and one-half the distance down the leech from the head. Measure your girths by folding the head (front corner of headboard) to the clew, smoothing the leech and marking the fold at the leech (MGM starting point). Next, fold the head to the mid-leech point and mark this new fold on the leech (MGU starting point). Now lay the sail out flat. Hold the zero end of a tape measure at the MGM starting point on the leech. Swinging an arc up and down the luff, record the minimum distance measured as your MGM. Remove the wrinkles from the area to be measured. Repeat this process for measuring your MGU.

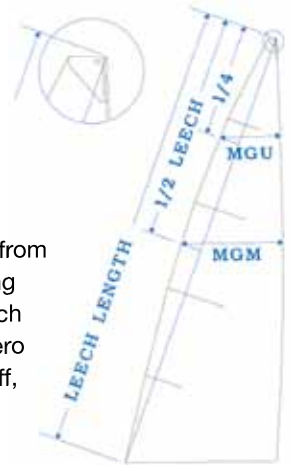

Py and Ey are similar to P and E dimensions for the aft sail on ketches, yawls and schooners.

## SYMMETRIC SPINNAKER

Symmetric spinnakers have the following characteristics: (a) luffs are of equal length; (b) the sail is symmetric about its vertical centerline.

SL = Spinnaker Luff (Refer to the NCPHRF Rules at [www.yra.org](http://www.yra.org) for the non-penalty limit.)

SSMG (Symmetric Spinnaker Mid-Girth)

SSMG is determined by measuring the width of your sail at mid-luff to mid-luff

SSF = Spinnaker Foot Length

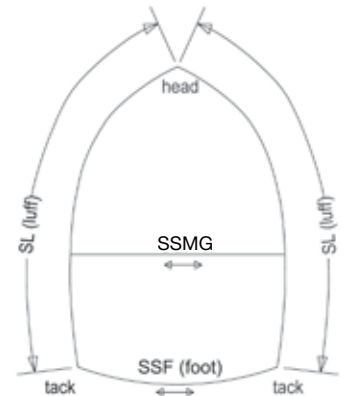

## ASYMMETRIC/CRUISING SPINNAKERS

Non-Penalty Area Limits

Cruising/Asymmetric Spinnakers are limited in area not to exceed the area of I and J – or ISP and SPL – based 180% symmetric spinnakers for that boat. To calculate the actual area for the symmetric spinnaker, use the formula for “Area” below, substituting SL (symmetric spinnaker luff) for SLU and SLE.

The formula for determining the actual area of all types of spinnakers is as follows:

$$\text{Area} = (\text{SLU} + \text{SLE}) \times .25 \times \text{ASF} + (\text{ASMG} - .5\text{ASF}) \times (\text{SLU} + \text{SLE}) / 3$$

In the case of Symmetric Spinnakers, replace SLU and SLE with SL, ASMG with SSMG, and ASF with SSF.

SLU = Spinnaker Luff Length

SLE = Spinnaker Leech Length

ASMG = Spinnaker mid-girth measured between the mid-points of the spinnaker luff and spinnaker leech

ASF = Spinnaker foot length

Note on ASMG:

ASMG less than .75 x ASF is not allowed.

How far aft can you articulate your spinnaker tack?

0 degs (fixed)

\_\_\_ degrees

We want to know if you plan on setting the tack of your cruising or asymmetric spinnaker on a pole that can be squared aft. Sails set from the bow of the boat, or from a non-rotating pole (bow sprit), are of the zero degree category. If the tack of the sail is set on a pole that can be rotated while sailing, we want to know the maximum angle of rotation, measured at the mast between the centerline of the yacht and the pole. If an asymmetric spinnaker is tacked to a spinnaker pole, articulation must be listed as 90 degrees.

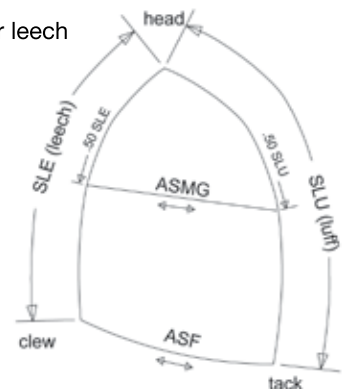

continued on page 46



# 2017 CBRA Series

12 Races spread out over 6 race days  
May, June, August & September

The CBRA series features 12 races spread over 6 race days for classic one-design fleets like the Bears, Birds, Folkboats, Knarrs, Cal 20's, Alerion Express 28's and Santana 22's. Races are held throughout the Central Bay.

You can enter the races, view the Notice of Race, and download the Sailing Instructions for the races at [www.jibeset.net](http://www.jibeset.net)

Save the Date: Trophies and Series Championships for CBRA Series races will be awarded on November 21, 2017 at the Berkeley Yacht Club.

---

# HELPFUL INFO FOR FILLING OUT AN NCPHRF APPLICATION

continued from page 44

Please fill out the following two fields in the “Foretriangle” box:

ISP = Spinnaker hoist, measured from the underside of the spinnaker halyard, when drawn horizontally forward from mast, to the level of the sheerline abreast the mast.

JSP = Farthest distance from front of mast to asymmetric spinnaker tack location. Note that this can be much greater than J on sprit boats.

Setting and Sheeting Limits: For asymmetric spinnakers:

TACK: Sail may be tacked to the deck or to a pole. PHRF Application must state if the pole can be articulated to move the tack off hull centerline and how many degrees it can move. JSP must be recorded if greater than J.

HEAD: Halyard location may be at any height on the mast. If the dimension ISP is greater than I, then ISP must be recorded on the application.

CLEW: Sail may be sheeted consistent with the RRS. Racing Rules of Sailing can be found on the US Sailing website at: [www.ussailing.org/rules](http://www.ussailing.org/rules).

The performance of Cruising/Asymmetric Spinnakers is not yet completely defined. Boats with excessive JSPs or ISPs and boats with the ability to move the tack of the sail off centerline may incur some rating adjustment. The PHRF Committee will be studying the performance of these various arrangements, and, if considered necessary by this committee, this rule and/or its limits may change.

## HULL MEASUREMENTS

Drawings and photos are not required for well-documented production boats. However, if the boat is relatively rare, or not common in the Bay Area, drawings and/or photos are a must. We cannot rate an unknown boat using only the information on the application form. Measurements below are for the boats in ‘measured trim,’ not ‘sailing trim,’ using IMS wording. Your boat is equipped as it would be for racing, but without crew, sea bags, or consumable supplies, and with all tanks empty.

### HULL

#### LENGTH OVERALL

How long is your boat? If it has a bowsprit, please give the length of the hull and the bowsprit separately.

#### WATERLINE LENGTH

How long is the part of the boat in the water? Ignore the rudder.

#### MAXIMUM BEAM

What is the width of your hull at its widest point?

#### MAXIMUM DRAFT

What is the depth of the lowest point of the keel or board below the waterline? If the boat has a lifting board or keel of any type, draft is measured with this device fully lowered. Give the change in draft with the board raised separately.

### DISPLACEMENT

#### TOTAL

This is the weight of your boat ready to race as described above.

#### BALLAST

We are looking for the weight of your keel. PHRF requires minimum ballast of 400 pounds. If your boat has ‘internal ballast’, it should be included. Internal ballast is typically in the form of lead ingots bolted to the hull, and is NOT in the form of usable equipment or supplies. If your boat has been measured under some rating rule, and you have subsequently removed the internal ballast, this change must be reported in writing to the PHRF Committee.

#### BALLAST MATERIAL

Typical answers here are lead or iron, and sometimes water.

#### TRAPEZE/HIKING STRAP

These are allowed in One-Design Classes where the class rules clearly state that the hiking aids are allowed. They may not be used unless your PRHF application so indicates.

continued on page 48



2017

# Weekend Regattas

**Great Vallejo Race**  
May 2nd & 3rd

**2nd Half Opener**  
August 2nd & 3rd

**Westpoint Regatta**  
July 18th

**Season Closer**  
September 26th & 27th

Be a part of some of the most historic races on San Francisco Bay! The YRA Weekend Regattas includes some of the longest running regattas on San Francisco Bay, and one of the biggest, but they all deliver great racing and great Saturday night after-race parties. Divisions are available for PHRF Boats, Sportboats, One Design Fleets and Multihulls. Short-handed and non-spinnaker fleet options may also be available.

Enter the races, view the Notices of Race, and download the Sailing Instructions for each Weekend Regatta at [www.Jibeset.net](http://www.Jibeset.net).

Save the Date: Trophies for Weekend Regattas will be awarded on November 21, 2017 at the Berkeley Yacht Club.

---

# HELPFUL INFO FOR FILLING OUT AN NCPHRF APPLICATION

continued from page 46

## MOVABLE BALLAST

Does your boat have ballast that can be moved while sailing? The possibilities include:

- (a) Water ballast which can be moved from side to side – or discharged for runs and restored for beating.
- (b) Keels which can be inclined or canted.
- (c) And others.

Movable ballast presents several difficulties. The biggest is in US Sailing/Racing Rules of Sailing (2017-2020) Rule #51 (Moving Ballast), which states quite clearly that movable ballast is not legal when racing under the US Sailing rules. There are a (very) few races where the race instructions alter the RRS, and specifically allow movable ballast, which is why this is on the PHRF form at all. If you use movable ballast, it is your responsibility to be sure that it is legal in the races in which you are sailing. *Just because it is on your PHRF Certificate does not mean you can race with a movable ballast.*

## KEEL TYPE

### FIXED

If your keel cannot be moved while you are sailing, then we consider it fixed.

### MOVABLE

If your keel can be moved while you are sailing, then we consider it movable, and we need to know about it. This includes keels that move up and down, pivot around a pin (swing keel), or cant from side to side.

### KEEL/CENTERBOARD

This is really a sub-class of movable keels, where the boat has a conventional keel, but also has a foil that can extend down below the bottom of the keel.

## ENGINE

Do you have an inboard, outboard, or no engine at all?

## PROPELLER

We need to know the number of blades on the propeller, and whether they are fixed blades or folding/feathering. If the engine is an outboard, we assume the propeller is not in the water while you are racing, so in the case of outboards, we do not consider what type of propeller you have.

## MODIFICATIONS

### UNMODIFIED CLASS BOAT

Check this box if your boat is a serially produced yacht that has not been altered.

### MODIFIED CLASS BOAT

Check this box if your boat was originally a production yacht, but has undergone changes since its original manufacture. Examples include: a new keel, change in ballast, new rudder, new mast made of different material than the original, different number of spreaders on the mast, change in hull shape, etc. Include anything that would make you *unwelcome* racing against your unmodified sisterships.

### NON-CLASS CUSTOM BOAT

Check this box if your boat is essentially a one-of-a-kind custom boat. If your boat is of this type, please refer to the NCPHRF Rules at [www.yra.org](http://www.yra.org) for information we will need to handicap your boat.

## DESCRIBE MODIFICATIONS

Please explain modifications, movable ballast, hiking aids here. Please feel free to write on the back of the form if you need more space.

## RATING FEES

New Certificates: YRA Members, \$50; Non-Members, \$75

Renewals: YRA Members, \$35; Non-Members, \$65

Out of Area Certificates (boats hailing from outside of US Sailing Area G): \$75

### CHANGES TO EXISTING CERTIFICATES

YRA Members: No charge

Non-Members: \$30



# NORTHERN CALIFORNIA PHRF RATING APPLICATION 2017

1070 Marina Village Pkwy, Ste 202-G, Alameda, CA 94501

Phone: (415) 771-9500 E-mail: PHRF@yra.org Fax: 415-276-2378

**THIS FORM IS FOR BOATS NOT PREVIOUSLY RATED OR BOATS WHICH DID NOT HAVE A 2016 CERTIFICATE.**

*The NCPHRF Committee has no responsibility for the seaworthiness or safety of yachts rated, but cites US SAILING Fundamental Rule 4, "It shall be the sole responsibility of each yacht to decide whether or not to start or to continue to race".*

|                               |                      |                     |
|-------------------------------|----------------------|---------------------|
| Name: _____                   | Boat Name: _____     | Sail Number: _____  |
| Street: _____                 | Boat Model: _____    |                     |
| City, State, Zip: _____       | Manufacturer: _____  | Yr Built: _____     |
| Evening Phone: _____          | Daytime Phone: _____ | Designer: _____     |
| Email Address: _____          |                      | Yr. Designed: _____ |
| U.S. Sailing #: _____         |                      | YRA Member #: _____ |
| Yacht Club Affiliation: _____ | Marina: _____        | Berth/Slip #: _____ |

**Please refer to the NCPHRF Rules and Guidelines for assistance in successfully completing this application**

**Do you want an ODR (One Design Rating)?**

YES NO N/A

**What is the source of the information provided?**

*Circle all that apply.*

Measurement Certificate Sales Brochure Class Rules Sailmaker Designer Own Measurement

**Please provide accurate drawings or pictures showing side and end views of your boat from deck to bottom of keel and attach to this application. Where possible, give measurements in feet and decimals.**

|                                                                                                                                                                                                                                                                                                                                                                                                 |                                                                                                                                                                                                                                                                                                                                 |                                                                                                                                                                                                                                                       |                                                                                                                                                                                                                                                                                                                                                                                                                                                                                                                               |
|-------------------------------------------------------------------------------------------------------------------------------------------------------------------------------------------------------------------------------------------------------------------------------------------------------------------------------------------------------------------------------------------------|---------------------------------------------------------------------------------------------------------------------------------------------------------------------------------------------------------------------------------------------------------------------------------------------------------------------------------|-------------------------------------------------------------------------------------------------------------------------------------------------------------------------------------------------------------------------------------------------------|-------------------------------------------------------------------------------------------------------------------------------------------------------------------------------------------------------------------------------------------------------------------------------------------------------------------------------------------------------------------------------------------------------------------------------------------------------------------------------------------------------------------------------|
| <p style="text-align: center;"><b>Foretriangle</b></p> <p>I: <input type="text"/> J: <input type="text"/></p> <p>Largest Headsail: <input type="text"/> % J SPL: <input type="text"/></p> <p>ISP: <input type="text"/> JSP: <input type="text"/></p> <p>Type of Rig: <input type="text"/></p> <p>Mast Material: <input type="text"/></p> <p>Standing Rigging Material: <input type="text"/></p> | <p style="text-align: center;"><b>Main</b></p> <p>P: <input type="text"/></p> <p>E: <input type="text"/></p> <p>HB: <input type="text"/></p> <p>MGU: <input type="text"/></p> <p>MGM: <input type="text"/></p> <p style="text-align: center;"><b>Mizzen</b></p> <p>PY: <input type="text"/></p> <p>EY: <input type="text"/></p> | <p style="text-align: center;"><b>Symmetric Spinnaker</b></p> <p>Yes/No <input type="checkbox"/></p> <p><i>If yes, complete the following:</i></p> <p>SL: <input type="text"/></p> <p>SSMG: <input type="text"/></p> <p>SSF: <input type="text"/></p> | <p style="text-align: center;"><b>Asymmetric/Cruising Spinnaker</b></p> <p>Yes/No <input type="checkbox"/></p> <p><i>If yes, complete the following:</i></p> <p>SLU: <input type="text"/> How far aft can you articulate your spinnaker tack? If an Asymmetric spinnaker is tacked to a spinnaker pole, articulation must be listed as 90 deg</p> <p>SLE: <input type="text"/></p> <p>ASMG: <input type="text"/></p> <p>ASF: <input type="text"/> <input type="checkbox"/> Fixed @ 0 deg or: <input type="text"/> Degrees</p> |
|-------------------------------------------------------------------------------------------------------------------------------------------------------------------------------------------------------------------------------------------------------------------------------------------------------------------------------------------------------------------------------------------------|---------------------------------------------------------------------------------------------------------------------------------------------------------------------------------------------------------------------------------------------------------------------------------------------------------------------------------|-------------------------------------------------------------------------------------------------------------------------------------------------------------------------------------------------------------------------------------------------------|-------------------------------------------------------------------------------------------------------------------------------------------------------------------------------------------------------------------------------------------------------------------------------------------------------------------------------------------------------------------------------------------------------------------------------------------------------------------------------------------------------------------------------|

|                                                                                                                                                                                                                               |                                                                                                                                                                                                                                                                                                                |                                                                                                                        |                                                                                                                |                                                                                                                                                                               |
|-------------------------------------------------------------------------------------------------------------------------------------------------------------------------------------------------------------------------------|----------------------------------------------------------------------------------------------------------------------------------------------------------------------------------------------------------------------------------------------------------------------------------------------------------------|------------------------------------------------------------------------------------------------------------------------|----------------------------------------------------------------------------------------------------------------|-------------------------------------------------------------------------------------------------------------------------------------------------------------------------------|
| <p style="text-align: center;"><b>Hull</b></p> <p>Length Overall: <input type="text"/></p> <p>Waterline length: <input type="text"/></p> <p>Maximum Beam: <input type="text"/></p> <p>Maximum Draft: <input type="text"/></p> | <p style="text-align: center;"><b>Displacement</b></p> <p>Total: <input type="text"/> lbs</p> <p>Ballast: <input type="text"/> lbs</p> <p>Ballast Material: <input type="text"/></p> <p># of Trapezes/Hiking Straps: <input type="text"/></p> <p>Is any of your ballast moveable? <input type="checkbox"/></p> | <p style="text-align: center;"><b>Keel</b></p> <p>Fixed, Moveable or Keel/Centerboard?</p> <p><input type="text"/></p> | <p style="text-align: center;"><b>Engine</b></p> <p>Inboard, Outboard or None?</p> <p><input type="text"/></p> | <p style="text-align: center;"><b>Propeller</b></p> <p># of Blades (2 or 3)?</p> <p><input type="text"/></p> <p>Fixed, Folding or Feathering?</p> <p><input type="text"/></p> |
|-------------------------------------------------------------------------------------------------------------------------------------------------------------------------------------------------------------------------------|----------------------------------------------------------------------------------------------------------------------------------------------------------------------------------------------------------------------------------------------------------------------------------------------------------------|------------------------------------------------------------------------------------------------------------------------|----------------------------------------------------------------------------------------------------------------|-------------------------------------------------------------------------------------------------------------------------------------------------------------------------------|

**This is a: (check one)**    Unmodified Class Boat     Modified Class Boat:     Non Class (Custom) Boat

**Modifications** Describe modifications/Comments/Moveable Ballast/Trapeze or Hiking Straps below:

The NCPHRF rating certificate is a contract between you, the NCPHRF Committee, and your competitors. You and your competitors expect this form to be accurate and that the reported characteristics will be maintained while racing. Failure to advise the NCPHRF Committee in writing of ANY modification to your boat which will alter its sailing performance may be grounds for protest and disqualification of the yacht. Your rating is valid through December 31 of the year issued. I certify that the above information is accurate and correct, that I have read the NORTHERN CALIFORNIA PHRF RULES AND GUIDELINES, and concur with, and agree to sail by those terms and conditions.

**Signature of owner** \_\_\_\_\_ **Date:** \_\_\_\_\_

*Rating Fees: \$100 (includes YRA membership) or \$50 (YRA member with a current membership) or \$75 (Non-YRA Member and out of area vessels)*  
 Make check payable to YRA. To pay by MasterCard or VISA please provide card information below, including billing street address and zip code

Card Number: \_\_\_\_\_ Exp Date: \_\_\_\_\_ CVV # \_\_\_\_\_ Name on Card: \_\_\_\_\_  
 Card Holder's Signature: \_\_\_\_\_ Billing Address: \_\_\_\_\_

**Office use only**  
**PHRF Rating:** \_\_\_\_\_ C.C. Check # \_\_\_\_\_ Amount PD \_\_\_\_\_ Date Rec'd in office \_\_\_\_\_



**PINEAPPLE SAILS**  
 Phone (510) 522-2200  
 www.PineappleSailingApparel.com  
 www.PineappleSails.com  
 2526 Blanding Ave., Alameda, CA 94501

Stocking Dealers For

**MUSTO**

Foul Weather Gear



**dubarry**  
of Ireland

Sailing Footwear

**spinlock**

PFDs and Tethers



*When only the best will do*

**FLAGS**

|   |  |   |  |   |  |                                         |  |
|---|--|---|--|---|--|-----------------------------------------|--|
| A |  | J |  | S |  |                                         |  |
| B |  | K |  | T |  |                                         |  |
| C |  | L |  | U |  |                                         |  |
| D |  | M |  | V |  |                                         |  |
| E |  | N |  | W |  |                                         |  |
| F |  | O |  | X |  |                                         |  |
| G |  | P |  | Y |  | 'Y' FLAG:<br>Life Jackets must be worn. |  |
| H |  | Q |  | Z |  |                                         |  |
| I |  | R |  | 0 |  |                                         |  |
| 1 |  | 2 |  | 3 |  |                                         |  |
| 4 |  | 5 |  | 6 |  |                                         |  |
| 7 |  | 8 |  | 9 |  |                                         |  |
|   |  |   |  |   |  |                                         |  |
|   |  |   |  |   |  |                                         |  |
|   |  |   |  |   |  |                                         |  |

★ For Bay Area Weather Call (831) 656-1725 ★

# JANUARY 2017

● indicates full moon.

→ indicates 2-day races. **YRA events indicated in bold type.**

| S  | M  | T  | W  | Th | F  | S  |
|----|----|----|----|----|----|----|
| 1  | 2  | 3  | 4  | 5  | 6  | 7  |
| 8  | 9  | 10 | 11 | 12 | 13 | 14 |
| 15 | 16 | 17 | 18 | 19 | 20 | 21 |
| 22 | 23 | 24 | 25 | 26 | 27 | 28 |
| 29 | 30 | 31 |    |    |    |    |

| WEEKDAY & SPECIAL EVENTS                                                                                                                                                                                                                                                        | SATURDAY                                                                                                                                                                                     | SUNDAY                                                                                                                                                          |
|---------------------------------------------------------------------------------------------------------------------------------------------------------------------------------------------------------------------------------------------------------------------------------|----------------------------------------------------------------------------------------------------------------------------------------------------------------------------------------------|-----------------------------------------------------------------------------------------------------------------------------------------------------------------|
| <p><b>January 1:</b> • Welcome to 2017</p> <p><b>January 15-20</b> • Quantum Key West Race Week, Storm Trysail Club – Key West, FL</p> <p><b>January 16:</b> • Martin Luther King Jr. Day</p>  |                                                                                                                                                                                              | Chowder #12, BYC – OC                                                                                                                                           |
|                                                                                                                                                                                                                                                                                 | California Dreamin', SDYC – San Diego → Seaweed Soup Midwinter #3, GGYC – City Midwinter #1, TYC – NB Frostbite Series #2, BenYC – Carquinez Opti/EI Toro Green Midwinters #2, RYC – Potrero | California Dreamin', SDYC – San Diego Island Days Midwinter #3, IYC – Estuary Chowder #13, BYC – OC Midwinter #3, SYC – Knox Small Boat Midwinters #2, RYC – SH |
|                                                                                                                                                                                                                                                                                 | Santana 22 Team Racing, SCYC – Santa Cruz Midwinters #5, BYC – OC Winter One Design Invitational #3, SYC/RegattaPRO – OC/SH                                                                  | Sunday Brunch #1, OYC – Estuary Midwinters #6, BYC – OC Robinson Midwinters #2, LMSC – Lake Merritt                                                             |
|                                                                                                                                                                                                                                                                                 | Midwinters #1, CYC – Knox → Jack Frost #2, EYC – YRA 10 Midwinters #3, SCYC – Santa Cruz Redwood Cup #3, SeqYC – SB Tiny Robbins Midwinter #3, VYC – NB                                      | Midwinters #2, CYC – Knox Sunday Brunch #2, OYC – Estuary Chowder #14, BYC – OC Spring Lake Winter Series, Santa Rosa SC                                        |
|                                                                                                                                                                                                                                                                                 | Three Bridge Fiasco, SSS – CB Island Fever #3, SBYC – SB/SF                                                                                                                                  | Chowder #15, BYC – OC Sunday Brunch #3, OYC – Estuary                                                                                                           |

## CHRIS BOOME INSURANCE AGENCY

800-853-6504  
San Francisco Bay



MARINE INSURANCE SPECIALIST WITH ACCESS TO ALL MAJOR CARRIERS

IF YOU OWN A BOAT OR CAR YOU NEED A PERSONAL UMBRELLA POLICY

IF YOU ARE GOING TO MEXICO IN YOUR BOAT OR CAR YOU NEED MEXICAN LIABILITY INSURANCE

### Here's what our customers have to say:

"I have been dealing with Chris Boome for over six years and 25,000 miles of coastal and ocean sailing. The service that Chris delivers allows me to sail with confidence knowing that I am fully covered wherever my sailing adventures take me. Chris being a sailor himself fully understands my requirements and has proven that he can provide a very competitively priced insurance policy."

– Rob Andrews, Swan 53 *Mistress*, Pacific Northwest

"Chris Boome goes above and beyond. When I suddenly came up on the South Beach Harbor waiting list 10 years ago, but with no boat, Chris recommended I consider an Islander 36. Chris has been insuring our Islander ever since. Over the years he has dispensed advice on racing, cruising, repairs and sailmakers. Recently we incurred some serious damage and Chris was right by my side working with boat yards, surveyors and the insurance company claims department to make sure Kapaï could enjoy another 10 years plus on the Bay."

– Rick Egan, I36 *Kapaï*, San Francisco Bay

"Chris Boome has consistently delivered the insurance we need for the past seven years. Despite the complex needs of a voyaging yacht with changing plans, Chris always delivered a solution. Working with Chris has always been a pleasure and his office has always been very efficient and provided added value."

– Herb Hunt, Custom Farr 50 P.H. *Wandering Farr*, Caribbean

"We have been using Chris Boome for insurance on *Golden Moon* for 14 years. Chris is knowledgeable and fair, and responds promptly to our needs. He is an expert sailor and brings great knowledge to all discussions on sailing. I recommend him whole heartedly."

– Kame Richards, Express 37 *Golden Moon*, San Francisco Bay

Call Chris 650-373-0595 • 650-464-0728 cell

Boomeins@aol.com

www.chrisboome.com

License: OA99058

THE VIEW IS A LOT BETTER  
WHEN THERE IS NO ONE  
IN FRONT OF YOU!

ERIK SIMONSON / WWW.PRESSURE-DROP.US



Buzz Blackett's *California Condor*\*

\*Powered by Pineapples.



## PINEAPPLE SAILS

2526 Blanding Ave  
Alameda, CA 94501  
www.PineappleSails.com  
**(510) 522-2200**

## YOUTH SAILING

Looking for a new way to entertain your kids this year? Look no further than the Bay Area's dozens of junior sailing programs. Many offer scholarships, and, with rare exception, you don't need to have your own boat. Unless noted below, club membership is not necessary. High School sailing for students in grades 9-12 takes place around Northern California in the Pacific Coast Interscholastic Sailing Association. If your high school doesn't have a team – or enough students to field a team – don't fret. Most programs allow students from several schools to form a single team.

### ALAMEDA COMMUNITY SAILING CENTER

(510) 629-9282, messages [www.sailalameda.org](http://www.sailalameda.org)

**Summer Camp**, ages 8-18. When: June, July and August.

8-13 age level camp – Discover Sailing (Entry Level training)

8-13 age level camp – Seasoned Sailors (for returning graduates of Discover Sailing)

13-18 age level camp – Teen Camp (for teens of all skill levels)

Discover Sailing runs all summer – check website for where Seasoned Sailors and Teen Camp dates will be added. Sessions are two weeks, Monday-Friday, 9 am-4 pm (Extended care 8:30 am-5 pm available.) Boats: JY Trainers, CFJs.

Needs-based scholarships available. Weekend classes, Open Sails and other sailing events will be scheduled throughout the year. Visit [www.sailalameda.org](http://www.sailalameda.org) for further details and pricing.

### BENICIA YC

Derith Lutz, (707) 746-0739, [youthsailing@beniciayachtclub.com](mailto:youthsailing@beniciayachtclub.com)

[www.beniciayachtclub.com](http://www.beniciayachtclub.com)

Dates TBA in late March on our website. YC member discounts, sibling and multiple camp discounts, and scholarships available on all programs.

**Half Day Camps**, ages 8-12 with no sailing experience. Cost: \$275

**Full Day, One week Camps**, ages 10-18 or young sailors with experience. Cost: \$375

**Intermediate Sailing**, more experienced sailors.

Boats: Vanguard 420, CFJ (provided). Cost: \$375

### High School Sailing Special Programs

Boats: DeWitt Dinghies, V420, CFJ (provided). Cost: Sponsored by BenYC for Benicia High School students.

**Open Sailing** for pre-qualified individuals with certification.

### BLUE WATER FOUNDATION (San Francisco)

(415) 392-2018; [www.bluewaterfoundation.org](http://www.bluewaterfoundation.org)

**Thursday Sails**: Afternoon sail programs with San Francisco Unified School District and the SF Police Department.

**Gleaming Ocean Program**: Four-month intensive sailing and teamwork course teaching cruising skills to selected high school students on a 43-ft Hans Christian cutter. Emphasis on building teamwork and self-confidence; mentor system is utilized.

**Oceans Gate Program**: Working with Alameda County Probation Department; convicted youth are given the opportunity to make their way back to society; offering both day sails and a multi-month intensive sail training program that will "graduate" successful students by ocean sailing.

**Community Sail Programs**: At least one weekend day a month we take various community groups sailing, ranging from Boys and Girls Clubs to Project Avery, an organization for children of incarcerated parents.

**Probation Dept. Sails**: This newest program works with various youth probation departments throughout the Bay Area and Nevada City/El Dorado County foothills, taking their incarcerated students and students on probation on repeat sails. Usually on weekends.

### COYOTE POINT YC (San Mateo)

[youthsailing@cpyc.com](mailto:youthsailing@cpyc.com), [www.cpyc.com/youth-sailing/](http://www.cpyc.com/youth-sailing/)

Welcome Aboard! Give your kids the gift of independence, adventure and learning a new skill they can use for a lifetime! The Coyote Point YC offers a weekly sailing camp for children ages 8 to 13 who wish to learn to sail and/or improve their skills. We have nine Optimist (Optis) sailboats, each 8-feet long, designed for junior sailors as a single-handed dinghy that is easy to manage and fun to sail. We also have two Lasers for the more advanced sailors.

**2017 Summer Sessions**: The camp runs Monday to Friday 9 am-4pm.

Cost: \$395 per session. 15% off for second child.

Session 1: June 19-23; Session 2: June 26-July 1; Session 3: July 10-14;

Session 4: July 17-21; Session 5: July 24-28; Session 6: July 31-Aug 4; Session 7: Aug. 7-11.

### ENCINAL YC (Alameda)

(510) 769-0221, [juniors@encinal.org](mailto:juniors@encinal.org), [www.encinal.org](http://www.encinal.org)

**Summer Learn to Sail Program**, ages 6-18, all levels.

When: Three-week sessions. Monday-Thursday, 8:30 am-12 or 1-4:30 pm.

Boats: Optimists, FJs, J/24s (provided).

**Advanced Race Team**, ages 9-18 by application only.

*continued on page 54*

# FEBRUARY 2017

● indicates full moon.

→ indicates 2-day races. **YRA events indicated in bold type.**

| S  | M  | T  | W  | Th | F  | S  |
|----|----|----|----|----|----|----|
|    |    |    | 1  | 2  | 3  | 4  |
| 5  | 6  | 7  | 8  | 9  | 10 | 11 |
| 12 | 13 | 14 | 15 | 16 | 17 | 18 |
| 19 | 20 | 21 | 22 | 23 | 24 | 25 |
| 26 | 27 | 28 |    |    |    |    |

| WEEKDAY & SPECIAL EVENTS                                                                                                                                                                                                                                     | SATURDAY                                                                                                                                                                                                                                                                                                                                                           | SUNDAY                                                                                                                                                                                                                        |
|--------------------------------------------------------------------------------------------------------------------------------------------------------------------------------------------------------------------------------------------------------------|--------------------------------------------------------------------------------------------------------------------------------------------------------------------------------------------------------------------------------------------------------------------------------------------------------------------------------------------------------------------|-------------------------------------------------------------------------------------------------------------------------------------------------------------------------------------------------------------------------------|
| <p><b>February 14:</b></p> <ul style="list-style-type: none"> <li>Valentine's Day: Take your sweetheart for a sail.</li> </ul> <p><b>February 20:</b></p> <ul style="list-style-type: none"> <li>Presidents' Day: Take your president for a sail!</li> </ul> | <p>Midwinter #2, TYC – NB<br/>Seaweed Soup Midwinter #4, GGYC – City<br/>Opti/EIToro Green Midwinters #3, RYC – Potrero<br/>Frostbite Series #3, BenYC – Carquinez<br/>Spring Series #1, FLYC – Folsom Lake<br/>Winter #3, SeqYC – SB</p> <p style="text-align: right;"><b>4</b></p>                                                                               | <p>Chowder #16, BYC – OC<br/>Small Boat Midwinters #3, RYC – SH<br/>Midwinter #4, SYC – Knox</p> <p style="text-align: right;"><b>5</b></p>                                                                                   |
|                                                                                                                                                                             | <p>BAYS Optis Regatta, EYC – Estuary →<br/>Midwinters #7, BYC – OC<br/>Winter One Design Invitational #4,<br/>SYC/RegattaPRO – OC/SH<br/>Santana 22 Team Racing, SCYC – Santa Cruz<br/>Robinson Midwinters #3, LMSC – Lake Merritt<br/>Spring Series #2, FLYC – Folsom Lake<br/>Single/Doublehanded #1, SeqYC – SB</p> <p style="text-align: right;"><b>11</b></p> | <p>BAYS Optis Regatta, EYC – Estuary<br/>Midwinters #8, BYC – OC<br/>Island Days Midwinter #4, IYC – Estuary</p> <p style="text-align: right;"><b>12</b></p>                                                                  |
|                                                                                                                                                                                                                                                              | <p>Midwinters #3, CYC – Knox →<br/>L.A. Midwinters, CBYC – San Pedro →<br/>Midwinters #4, SCYC – Santa Cruz<br/>Tiny Robbins Midwinter #4, VYC – NB<br/>Winter #4, SeqYC – SB</p> <p style="text-align: right;"><b>18</b></p>                                                                                                                                      | <p>Midwinters #4, CYC – Knox<br/>L.A. Midwinters, CBYC – San Pedro<br/>Chowder #17, BYC – OC<br/>Sunday Brunch #4, OYC – Estuary<br/>Spring Lake Winter Series, Santa Rosa SC</p> <p style="text-align: right;"><b>19</b></p> |
|                                                                                                                                                                                                                                                              | <p>California Dreamin', LBYC – Long Beach →<br/>Jack Frost #3, EYC – YRA 10<br/>Island Fever #4, SBYC – SB/SF<br/>Redwood Cup #4, SeqYC – SB<br/>Spring Series #3, FLYC – Folsom Lake</p> <p style="text-align: right;"><b>25</b></p>                                                                                                                              | <p>California Dreamin', LBYC – Long Beach<br/>Chowder #18, BYC – OC<br/>Midwinter Champ of Champs, BYC – OC<br/>Sunday Brunch #5, OYC – Estuary</p> <p style="text-align: right;"><b>26</b></p>                               |

CHRIS RAY / WWW.CRAYVPC.COM

# TRANSPAC 2017

THE FORTY NINTH RACE FROM LOS ANGELES, CA TO HONOLULU, HI



*Downwind to Paradise.....  
The Greatest Race  
Across the Pacific*

First Start .. Monday, July 3, 2017

Notice of Race and full entry information available now at [www.TranspacYC.com](http://www.TranspacYC.com)

Contact Entry Chair Chris Hemans at:  
[hemansconstruction@gmail.com](mailto:hemansconstruction@gmail.com)

*Aloha*



Photos by Sharon Green and Doug Gifford/ULTIMATESAILING.COM



# BAMA

Bay Area Multihull Association

38<sup>TH</sup> Annual

## Double Handed Farallones Race



March 18

JAN ROLETTO

### Bay Area Multihull Association

- Competitive Racing
- BAMA Cup Series
- Web Based Crew List
- Monthly Cruise-outs
- Multihull Seminars
- Social Activities

DHF2017@sfbama.org  
 Info@sfbama.org  
 650-394-6343

[www.sfbama.org](http://www.sfbama.org)

## MODERN SAILING SCHOOL AND CLUB



START RACING TODAY!

### LEARN TO RACE CLINICS

*offered three times a year!*

Learn to Race Clinics have a multi-day curriculum designed for the novice racer. Training in the fundamentals of racing include tides and currents, sail trim, basic tactics, starts, rounding marks, and basic spinnaker sailing.

JOIN A TEAM

*Coach on board to facilitate training.  
 Learn by actually racing!*

**Recreation** - Lightly competitive, great for recent clinic graduates  
**Performance** - Higher intensity, great for second year racer

Both teams participate in Spring, Summer, and Mid-Winter Races, along with major regattas throughout the year.

SAUSALITO, CA  
 (415) 331 - 8250

ModernSailing.com  
 office@modernsailing.com

## YOUTH SAILING

*continued from page 52*

### ENCINAL YC (Alameda) *Continued*

When: Spring/Summer/Fall. Boats: Optimists, Lasers, 420s (provided).

**High School Program**, grades 8-12.

When: Weekends and after school September-April. Boats: FJs (provided).

Scholarships available through the Encinal Sailing Foundation.

### GOLD COUNTRY YACHT CLUB

education@gcyc.net, www.gcyc.net

Our Youth sailing education program teaches beginning sailing on Sunfish sailboats. Classes are one-week long, 9 am-4 pm each day. We have beginning and intermediate instruction on CFJ sailboats for the advanced beginners. Classes are held in June and July on Scotts Flat Lake. Check calendar for class dates on the website or contact us at the email above.

### GOLDEN GATE YC (San Francisco)

www.ggyc.org

**High School Sailing**, grades 8-12.

When: Tuesdays and Thursdays, 4 pm to dusk during the school year. Boats: FJs (provided).

Scholarships available through the GGYC Youth Sailing Foundation.

### INVERNESS YC

www.invernessyachtclub.org (see Youth Sailing tab)

**Youth Sailing Camp**, ages 10-18.

Sponsored by the Inverness Yacht Club on Tomales Bay, Inverness CA (Marin County).

Two three-week sessions: June 26-July 14 and July 18-August 4.

When: Daily from 9 am-4 pm; 10 am-5 pm, depending on tides.

Fee: \$950 per session. Scholarships available.

### LAKE YOSEMITE SAILING ASSOCIATION (Merced)

Brigitte Bowers-Loeffler, (209) 357-7049, brigitematt@comcast.net,

www.lakeyosemitesailing.org

**Sail Camp**, ages 8-16, able to swim.

When: Multiple Sessions TBA. Boats: Lido 14s (provided).

**Mini Camp**, ages 8-10, 9 am-1 pm. Cost: \$125.

**Basic Camp**, ages 10-16, 9 am-4 pm. Cost: \$180.

**Advanced Camp**, any age, must have completed Basic course. 9 am-4 pm. Cost: \$180.

Scholarship program, member discounts; multiple siblings and/or multiple weeks receive 15% discount.

### MONTEREY PENINSULA YC

junioradvisor@mpyc.org, www.mpyc.org

**Varsity Sailing Team**, grades 8-12. When: Practices weekly, September-June.

**Junior Sailing Team**, grades 6-7. When: Practices twice monthly, September-June.

**Summer Sailing Camp**, ages 8-17. When: Weekly sessions from June through the end of July.

See website for more information about these programs.

### NEHEMIAH (Richmond)

(510) 234-5054, www.sailingacross.com

Crosscurrent Voyages use experiential education, adventure and managed risk-taking for growth and development. Primary goal is assisting youth and youth-at-risk to develop a strong sense of character and community, while instilling self-esteem in a hands-on situation.

### OAKLAND PARKS & RECREATION

Sarah Herbelin, (510) 238-2196, www.sailoakland.com

**Sailing into Science**, fifth graders (teachers may sign up their classes).

Where: Lake Merritt Boating Center. When: School year.

Boats: Pedalboats, dragonboats, kayaks, canoes, whaleboats (provided).

Cost: \$300 per class per day (up to 32 students).

**After-School Learn-to-Sail Program**, ages 10-17.

Where: Lake Merritt Boating Center. When: Weekday afternoons during the school year.

Boats: Optis (provided). Cost: \$165/10 weeks.

**Basic & Intermediate Summer Programs**, ages 10-17.

Where: Lake Merritt Boating Center. When: One-week sessions, June-August.

Boats: Optis, Sunfish, Catalina 14.2, Hobie Wave (provided).

Cost: \$180/Oakland residents; \$216/non-residents.

**Advanced Summer Program**, ages 11-17.

Where: Jack London Aquatic Center (Oakland Estuary).

When: One-week sessions, June-August.

Boats: Hobie 16s, Bytes (provided). Cost: \$195 and up.

**Youth Sailing Team**, grades 8-12 from any school.

Where: Jack London Aquatic Center (Oakland Estuary).

When: Practices and regattas on weekends spring and summer.

Boats: Laser 4.7s or club FJs (provided).

Cost: \$395-\$450/season. Scholarships available for Oakland residents.

### PEGASUS PROJECT (Berkeley)

(510) 414-2796, www.pegasusvoyages.org/project.html

Mission is to enable youth to become productive members of a

*continued on page 56*

# MARCH 2017

→ indicates 2-day races.  
**YRA events indicated in bold type.**

● indicates full moon.

| S  | M  | T  | W  | Th | F  | S  |
|----|----|----|----|----|----|----|
|    |    |    | 1  | 2  | 3  | 4  |
| 5  | 6  | 7  | 8  | 9  | 10 | 11 |
| 12 | 13 | 14 | 15 | 16 | 17 | 18 |
| 19 | 20 | 21 | 22 | 23 | 24 | 25 |
| 26 | 27 | 28 | 29 | 30 | 31 |    |

## WEEKDAY & SPECIAL EVENTS

- March 8:**
- **Latitude 38 Spring Crew List Party at the GGYC. Check Latitude 38 for more information or see [www.latitude38.com](http://www.latitude38.com).**
- March 17:**
- **St. Patrick's Day: Take an Irish friend sailing!**
- March 20:**
- **Vernal Equinox**



## SATURDAY

Spring Keel/Spring One Design, StFYC – City →  
 Mercury Series #1, EYC – Estuary  
 Midwinter #3, TYC – NB  
 Seaweed Soup Midwinter #5, GGYC – City  
 Sail-a-Small-Boat Day, RYC – Potrero Channel  
 Long Distance Race #1, SSC – Stockton  
 Frostbite Series #4, BenYC – Carquinez  
 Spring Series #4, FLYC – Folsom Lake  
 Single/Doublehanded #2, SeqYC – SB  
 Frostbite Series #1, ElkYC – Moss Landing

4

Big Daddy, RYC – OC →  
 California Dreamin', StFYC – City →  
 Santana 22 Team Racing, SCYC – Santa Cruz  
 Doublehanded Long Distance, SSC – Stockton  
 Rites of Spring, OYC – CB/OC  
 Redwood Cup #5, SeqYC – SB

11

Spring Dinghy, StFYC – City →  
 Doublehanded Farallones, BAMA – Ocean  
 Jack Frost #4, EYC – YRA 10  
 Small Boat Races #1, EYC – Estuary  
 Island Fever #5, SBYC – SB/SF  
 Frostbite Series #2, ElkYC – Moss Landing  
 Midwinter #5, SCYC – Santa Cruz  
 Spring Series #5, FLYC – Folsom Lake  
 Tiny Robbins Midwinter #5, VYC – NB

18

San Francisco Cup, SFYC – OC →  
 Jaws Pursuit Race, SYC – Knox/Blossom  
 Corinthian Race, SSS – CB

25

## SUNDAY

Spring Keel/Spring One Design, StFYC – City  
 Chowder #19, BYC – OC  
 Small Boat Midwinter #4, RYC – SH  
 Spring Series #1, SSC – Stockton  
 Midwinter #5, SYC – Knox  
 Sadie Hawkins, IYC – Estuary

5

Big Daddy, RYC – OC  
 California Dreamin', StFYC – City  
 Chowder #20, BYC – OC  
 Island Days Midwinter #5, IYC – Estuary  
 Robinson Midwinters #4, LMSC – Lake Merritt

DAYLIGHT SAVING TIME BEGINS

12

Spring Dinghy, StFYC – City  
 Chowder #21, BYC – OC  
 Sunday Brunch #6, OYC – Estuary  
 Third Sunday Series #1, PresYC – CB  
 Spring Lake Winter Series, Santa Rosa SC

19

San Francisco Cup, SFYC – OC  
 Sunday Brunch #7, OYC – Estuary  
 Chowder Series #22, BYC – OC  
 Spring Series #2, SSC – Stockton

26

# 2017 California Offshore Race Week



**Spinnaker Cup**  
 May 26th or 27th  
 (TBD at Press Time)



**Coastal Cup**  
 May 29th



**In-Port Race**  
 May 31st



**SoCal 300**  
 June 1st



**Encinal Yacht Club, San Francisco Yacht Club,  
 Monterey Peninsula Yacht Club,  
 Santa Barbara Yacht Club, and  
 San Diego Yacht Club**  
 invite you to participate in the second  
 running of this exciting ocean series.  
 Enter any leg, or enter the entire series!



**California OFFSHORE RACE WEEK**  
 MAY 27 - JUNE 3, 2017

[www.offshoreraceweek.com](http://www.offshoreraceweek.com)



# VALLEJO MARINA

Gateway to the Bay & Delta



## JOIN US!

We love making new friends and spoiling them!

- Competitive Rates
- Ample Guest Dock
- Full Service Boat Yard and Chandlery
- 2 Restaurants for Breakfast, Lunch, Cocktails and Dinner
- Covered and Open Berths
- Kayak Storage Now Available

## 2017 VALLEJO RACE May 6-7



Race to Vallejo for Dinner!

Photo by Peter Lyons • www.lyonsimaging.com



- One hour from Sacramento
- Only three hours from Reno
- Easy access to San Francisco Bay and the Delta

**(707) 648-4370**

Fax (707) 648-4660 • Kimberley.Lindo@cityofvallejo.net

42 Harbor Way • Vallejo, CA 94590

[www.ci.vallejo.ca.us](http://www.ci.vallejo.ca.us)

## YOUTH SAILING

continued from page 54

### PEGASUS PROJECT (Berkeley) *Continued*

sustainable society through positive outdoor environmental education and by reinforcing life skills. Objectives: Lifeskills Sails aboard Pegasus for youth including youth at risk; to provide youth participants (and adult crew) with a basic environmental understanding and appreciation of the San Francisco Bay; to provide a multi-year track for underprivileged youth that will enable them to experience their backyard Bay through on-the-water activities.

### RICHMOND YC

(510) 237-2821, [www.richmondyc.org](http://www.richmondyc.org)

Parent or child must be RYC member.

**Summer Junior Clinic**, ages 8-18.

When: One-week sessions.

**29er Summer Camp**, ages 14-18, 9:30 am-3:30 pm.

Bring your own 29er. Some (rental) charters available.

**420/Laser Summer Camp**, ages 14-18, 9:30 am-3:30 pm.

Bring your own boat. Some club boats available to share.

**El Toro/Opti Summer Camp**, ages 8-18, 9 am-3 pm.

Some club Optis available for charter – use during program hours only.

**Winter Sailing**, youth and juniors; 8-18. Registration starts August 1.

420s: October-March. Club boats available.

High School: October-May. Club boats available.

29ers: October-May. Club boats available.

Lasers: October-March. Some club boats available.

Optimists: October-March. Some club boats available.

El Toros: October-March (BYO).

### SACRAMENTO STATE AQUATIC CENTER

(916) 278-2842 or [www.sacstateaquaticcenter.com](http://www.sacstateaquaticcenter.com)

**Summer Youth Aquatic (Basic) Camp**, ages 7-17.

Weekly program of sailing and other boating activities.

Qualifies students to rent specific sailboats outside of camp.

Boats: Lasers, Holders, Hobie Cats and keelboats.

### SAILING EDUCATION ADVENTURES (San Rafael)

(415) 775-8779, [www.sfsailing.org/camps](http://www.sfsailing.org/camps)

**Mini Camp**, ages 8-10. Where: Loch Lomond Marina.

When: One-week sessions, Monday-Friday, 9 am-12 pm. Boats: Catalina 16.5 keelboats,

Capri 14.2s, RS Quests. Cost: \$325. Scholarships available.

**Summer Camp Basic/Intermediate**, ages 10-16. Where: Marin YC.

When: Two-week sessions, Monday-Friday, 9 am-4 pm. Boats: Laser Picos, Lasers.

Cost: \$725. Scholarships available.

**Advanced/Intro Race Camp**, ages 12-18. Where: Loch Lomond Marina.

When: One-week sessions, Monday-Friday, noon-4 pm.

Boats: Catalina Capris, RS Quests. Cost: \$350. Scholarships available.

**SEA Explorers**, ages 8-16.

[www.sfsailing.org/explorers](http://www.sfsailing.org/explorers)

Where: Marin YC. When: One-week session, Monday-Friday, 9 am-4 pm.

Boats: Laser Picos, Catalinas, RS Quests. Cost: \$425. Scholarships available.

### ST. FRANCIS YC (San Francisco)

Brent Harrill, (415) 820-3729, [www.stfyc.com](http://www.stfyc.com)

**Learn to Sail Program**, ages 7-16.

When: Saturday mornings, September-November and March-May.

Boats: Optimists, RS Teras, 420s (provided).

**Cityfront Summer Sailing Camps**, ages 7-16.

When: 1-week sessions, Monday-Friday, 9 am-4 pm. Check website for dates.

Boats: Optis, RS Teras, C420s, windsurfers (provided).

**Tinsley Island Summer Overnight Sailing Camps**, ages 8-15.

When: 1-week sessions, Monday-Friday. Check website for dates.

Boats: Optis, RS Teras, Bytes, Lasers, windsurfers, kayaks, paddle boards (provided).

**Learn to Windsurf Program**, ages 8-16

When: Saturdays, September-November and March-May.

Boards: Bic Techno 293 windsurfers (provided).

**Introduction to Racing Program**, ages 9-16

When: Sundays, September-November and March-May.

Boats: Optimists and 420s (provided). Cost: See online for fee for all above.

### SF MARITIME NATIONAL MARITIME PARK (San Francisco)

Alice Watts, (415) 561-6662 ext. 1004, [www.maritime.org](http://www.maritime.org)

Maritime Park Association operates education programs to increase

understanding of our nation's rich maritime heritage.

Programs include daytime and environmental living programs at the Hyde Street Pier.

**The Age of Sail/Teacher Workshops**: The Gold Rush, Life on the Barbary Coast.

**Overnight Encampment on a Tall Ship Educational Tours/Day Programs, Where**

continued on page 58



# APRIL 2017

→ indicates 2-day races.  
**YRA events indicated in bold type.**

● indicates full moon.

| S  | M  | T  | W         | Th | F  | S  |
|----|----|----|-----------|----|----|----|
|    |    |    |           |    |    | 1  |
| 2  | 3  | 4  | 5         | 6  | 7  | 8  |
| 9  | 10 | 11 | 12        | 13 | 14 | 15 |
| 16 | 17 | 18 | 19        | 20 | 21 | 22 |
| 23 | 24 | 25 | <b>26</b> | 27 | 28 | 29 |
| 30 |    |    |           |    |    |    |

## WEEKDAY & SPECIAL EVENTS

- April 1:** • Take a fool sailing!
- April 6-9:** • Pacific Sail & Power Boat Show – Craneway Pavilion & Marina Bay Yacht Harbor, Richmond
- April 15-16:** • Rainier Cup, CGRA
- April 22:** • Celebrate Earth Day on the liquid part.
- April 28-30:** • Newport to Ensenada Race, NOSA



CGRA

| SATURDAY                                                                                                                                                                                                                                                                                                                                                                                 | SUNDAY                                                                                                                                                                                                        |
|------------------------------------------------------------------------------------------------------------------------------------------------------------------------------------------------------------------------------------------------------------------------------------------------------------------------------------------------------------------------------------------|---------------------------------------------------------------------------------------------------------------------------------------------------------------------------------------------------------------|
| Wheeler Regatta, BYC – OC/SB →<br>J/Fest, StFYC – City →<br>NorCal High School @ TISC →<br>Camellia Cup, FLYC – Folsom Lake →<br>Horsfall-Vincent Regatta CC #1, CYC – Knox<br>Don Wan Regatta, TYC – NB<br>Champion of Champions Regatta, SCYC – Santa Cruz<br>Long Distance Race #2, SSC – Stockton<br>Single/Doublehanded #3, SeqYC – SB<br>Frostbite Series #3, ElkYC – Moss Landing | Wheeler Regatta, BYC – OC/SB<br>J/Fest, StFYC – City<br>NorCal High School @ TISC<br>Camellia Cup, FLYC – Folsom Lake                                                                                         |
| 1                                                                                                                                                                                                                                                                                                                                                                                        | 2                                                                                                                                                                                                             |
| Opti Harken #1, SFYC – OC →<br>Big Dinghy, RYC – SH →<br>Interconference, StFYC – City →<br>CBRA Invitational #1, SYC – West Alcatraz/Knox<br>Mercury Series #2, EYC – Estuary<br>Doublehanded Lightship, IYC – Ocean<br>South Bay Interclub #1, TIYC – SB/Alameda<br>Commodore's Cup, BVBC – SB/SF<br>Santana 22 Team Racing, SCYC – Santa Cruz                                         | Opti Harken #2, SFYC – OC<br>Big Dinghy, RYC – SH<br>Interconference, StFYC – City<br>Spring Series #3, SSC – Stockton<br>Estuary Cup, EYC – YRA 10/Alcaz/Estuary<br>Spring Lake Winter Series, Santa Rosa SC |
| 8                                                                                                                                                                                                                                                                                                                                                                                        | 9                                                                                                                                                                                                             |
| Trans-Folsom Challenge, FLYC – Folsom Lake<br>Small Boat Races #2, EYC – Estuary<br>Round the Rocks, SSS – CB<br>Spring One Design #1, SCYC – Santa Cruz                                                                                                                                                                                                                                 | Third Sunday Series #2, PresYC – CB<br><br>EASTER                                                                                                                                                             |
| 15                                                                                                                                                                                                                                                                                                                                                                                       | 16                                                                                                                                                                                                            |
| Resin Regatta, SFYC – OC →<br><b>YRA OYRA Lightship, StFYC – Ocean</b><br>Spring Twilight Series #1, EYC – Estuary<br>North Bay Series #1 VYC – NB<br>Intraclub, StFYC – City<br>El Toro Bullship Race, SYC – City<br>Summer #1, SeqYC – SB                                                                                                                                              | Resin Regatta, SFYC – OC<br>Spring Series #4, SSC – Stockton<br>SCORE #1, SCYC – Santa Cruz                                                                                                                   |
| 22                                                                                                                                                                                                                                                                                                                                                                                       | 23                                                                                                                                                                                                            |
| Intraclub Race 1, RYC – CB<br>Anniversary Cup/Staff Commodore's Cup, SFYC – Knox<br>Twin Island Race #1, SYC – Knox/Alcatraz<br>Commodore's Regatta, SCYC – Santa Cruz<br>Knocti Cup, KBSC – Clear Lake                                                                                                                                                                                  | Spring Series #5, SSC – Stockton                                                                                                                                                                              |
| 29                                                                                                                                                                                                                                                                                                                                                                                       | 30                                                                                                                                                                                                            |



# GREAT VALLEJO RACE

*All are Invited*

**MAY 6-7, 2017**

*Racers and Cruisers*

**SAIL THE YRA SCORED SEASON OPENERS & COME TO THE PARTY!**

Entertainers, Exhibits, and Sponsor Booths in the Afternoon  
 Various Food Vendors will be Open 3pm to 8pm Saturday  
 Live Band and Dance in the Main Hall – Saturday Evening  
 More information will be at [www.VYC.org](http://www.VYC.org)





## CONGRATULATIONS



WWW.H2OSHOTS.COM

Pacific Cup winner, *Redhead*, sporting her new Ullman FiberPath sails.

Walter Smith, owner of the Cal 40 *Redhead*, took 1st in Class, 3rd Overall, and 1st Crewed Boat in the 2016 Pacific Cup.

Congratulations to Walter and crew, plus Rowan Fennell, Navigator Trophy Winner!

## Ullman Sails San Francisco & Monterey Bay

104 Bronson St. #20, Santa Cruz, CA  
831.454.0868  
dhodges@ullmansails.com

Robin Sodaro  
415.332.4117

rsodaro@ullmansanfrancisco.com

Synthia Petroka  
510.205.9412

spetroka@ullmansails.com

## YOUTH SAILING

continued from page 56

**SF MARITIME NATIONAL MARITIME PARK** (San Francisco) *Continued*  
**History Meets Science, Educational Overnight Program** and more daytime and overnight programs aboard USS *Pampanito* submarine.

**SFSU DEPT. OF RECREATION, PARKS & TOURISM** (Lake Merced, SF)  
Patrick Tierney, <http://recdept.sfsu.edu/sailing>

**Summer Youth Sailing Camps, Paddling Camps, and Sailing & Science Camps**, ages 8-15. When: June 12-August 11, Monday-Friday. Paddling Camp 9 am-noon; Sailing Camp 1-4 pm; Sailing & Science Camp 9 am-4pm. Boats: Optis, JY 15s, double kayaks, SUPs (boats, boards & PFDs provided). Cost: Half day week-long camps \$189-\$199; full day week-long Science Camp \$399. Scholarships for low-income groups are available (no individual scholarships provided).

**SAN FRANCISCO YC** (Belvedere)

Youth Office, (415) 435-9525, [youth@sfdc.org](mailto:youth@sfdc.org), [www.sfdc.org/youth](http://www.sfdc.org/youth)

**Summer Learn-to-Sail Program**, ages 7-16. When: 2-week half-day, part-day and full-day sessions, mid-June through mid-August, Monday-Friday 9am-3:30pm. Boats: Optis, JYs, CFJs, J/24s (provided).

**Race Teams**, ages 8-18, all levels. When: All Year.

Boats: Optis, Lasers, C420s (privately owned).

**High School Program**, grades 9-12 from Marin Academy, Marin Catholic, Branson, or Redwood High School. When: September-May, Tuesday-Thursday, after school. Pricing listed on website, subject to change.

Scholarships available through the Belvedere Cove Foundation.

**SANTA CRUZ YC**

(831) 425-0690, [www.scyc.org](http://www.scyc.org)

**El Toro Program**, ages 8-14.

Where: Pinto Lake, Watsonville. When: Sundays, September-March.

Boats: El Toros (some available for charter). Cost: YC junior membership + program fee.

**Scholastic Program**, grades 8-12.

Where: Practice at Santa Cruz Yacht Harbor, regattas at Northern California YCs.

When: Saturdays, and select Fridays and holidays September-March. Boats: FJs.

Cost: YC junior membership + program fee; additional fee for Fridays and special holidays.

**Advanced Sailing Program**, grades 8-12.

Support for advanced junior sailors with their own boats.

Boats: Lasers, 29ers, and Keel boats: Melges 24s, Moore 24s and SC 52s.

Cost: YC junior membership + program fee.

**SEA SCOUTS SAN FRANCISCO** (Aquatic Park)

Tamara Sokolov, (415) 517-3943, Dennis Lindemann (415) 585-8825,

[www.corsair-viking.org](http://www.corsair-viking.org)

**Year-Round Program**, ages 13-18. When: Saturdays, 9:30 am-5 pm, Tuesdays, 5-8 pm, two-week, weekend and overnight cruises.

Boats: 30-ft sailing whaleboats, FJs, Cal 20s, more. Cost: \$60/semi-annually.

**SEQUOIA YC** (Redwood City)

Office, (650) 361-9472, [www.sequoiayc.org/jr\\_sailing](http://www.sequoiayc.org/jr_sailing)

Where: Redwood Creek. When: Saturdays.

**Winter/Spring Session**, starts February 4.

**Fall Session**, starts September 9.

**Beginner and Intermediate Sailing**, ages 8+. Boats: El Toros.

**Advanced Sailing**, ages 12+. Boats: Lasers.

Cost: \$190, scholarships available.

**SOUTH BEACH YC** (San Francisco)

[www.southbeachyc.org](http://www.southbeachyc.org)

**Junior Program**, ages 9-17, able to swim. 1-week sessions, 6/19-8/4, M-F, 9 am-4 pm.

Boats: RS Teras, Laser 4.7s, FJs (boats provided). Cost: \$TBD/week; after 4/15, cost will increase \$20. Scholarships available for kids in need.

**SPAULDING WOODEN BOAT CENTER** (Sausalito)

(415) 332-3179, [www.spauldingcenter.org](http://www.spauldingcenter.org)

**Youth Boat Building Program**, ages 11-17.

We are currently developing a variety of afterschool classes to take place on Monday and Wednesday afternoons. Our two-week Summer Youth Program is scheduled for the last week in July and first week in August. If you would like to build your first boat, make a new set of oars, design a toolbox or even press your own skateboard, we have a class for you.

**SPINNAKER YC** (San Leandro)

(510) 351-7905, (510) 357-0601, [www.spinnakeryachtclub.org](http://www.spinnakeryachtclub.org); click on Jr. Sailing

**Junior Program**, ages 10-18, able to swim. When: Monday-Friday, 9 am-1 pm.

See website for schedule and sign-up details. Boats: DeWitt Dinghies (provided).

Cost: See website for San Leandro residents and non-residents fees.

continued on page 60

# MAY 2017

→ indicates 2-day races.  
**YRA events indicated in bold type.**

● indicates full moon.

| S  | M  | T  | W  | Th        | F  | S  |
|----|----|----|----|-----------|----|----|
|    | 1  | 2  | 3  | 4         | 5  | 6  |
| 7  | 8  | 9  | 10 | 11        | 12 | 13 |
| 14 | 15 | 16 | 17 | 18        | 19 | 20 |
| 21 | 22 | 23 | 24 | <b>25</b> | 26 | 27 |
| 28 | 29 | 30 | 31 |           |    |    |

## WEEKDAY & SPECIAL EVENTS

- May 13-14:** • PSU Invite, CGRA
- May 26 or 27:** • Spinnaker Cup, SFYC/MPYC – Ocean (Date TBD)
- May 29-31:** • Coastal Cup, MPYC/SB – Ocean
- May 29:** • Memorial Day



KRISTEN SOETEBIER

## SATURDAY

**YRA Great Vallejo Race, VYC – NB →**  
 Elvstrom Zellerbach, StFYC – City →  
 Moore 24 Regatta, SCYC – Santa Cruz →  
**YRA CBRA #1, RYC – SH**  
 Championship Series #2, CYC – Knox  
 Behrens Regatta, TYC – NB  
 Singlehanded Race, SSC – Stockton  
 Rosenblum Regatta, SFYC – Knox

6

J/Fleet Series Stop, StFYC – City →  
**YRA CBRA #2, SFYC – OC**  
**YRA OYRA Duxship – Ocean**  
 North Bay Series #2/Brothers Race, VYC – NB  
 Mercury Series #3, EYC – Estuary  
 Flight of the Bulls, El Toros – Foster City Lagoon  
 Interclub #2, IYC – SB/Main Bay  
 Santana 22 Team Racing, SCYC – Santa Cruz  
 Summer #2, SeqYC – SB

13

USMRC Qualifier, StFYC – City →  
 Elite Keel Regatta, SFYC – OC →  
 LISA Regatta – Lake Yosemite →  
**YRA Series #1, BYC – OC**  
 Otter Cup, ElkYC – Moss Landing to  
 Monterey & back  
 Lady and the Tramp, FLYC – Folsom Lake  
 Small Boat Races #3, EYC – Estuary  
 Friendship Regatta, TYC/CYC – NB  
 Singlehanded Farallones, SSS – Ocean  
 Spring One Design #2, SCYC – Santa Cruz  
 Single/Doublehanded #4, SeqYC – SB

20

Memorial Day Regatta, ABYC – Long Beach →  
 Master Mariners Regatta, SYC – City

27

## SUNDAY

**YRA Great Vallejo Race, VYC – NB**  
 Elvstrom Zellerbach, StFYC – City  
 Moore 24 Regatta, SCYC – Santa Cruz

7

J/Fleet Series Stop, StFYC – City

MOTHER'S DAY

14

USMRC Qualifier, StFYC – City  
 Elite Keel Regatta, SFYC – OC  
 LISA Regatta – Lake Yosemite  
 Spring Series #6, SSC – Stockton  
 Third Sunday Series #3, PresYC – CB  
 Fremont Relays, El Toros  
 Spring Lake Summer Series, Santa Rosa SC

21

Memorial Day Regatta, ABYC – Long Beach  
 SCORE #2 Regatta, SCYC – Santa Cruz

28



# Delta Ditch Run

## June 10, 2017



The Delta Ditch Run starts in the San Francisco Bay and goes up the Delta, finishing at Stockton Sailing Club. In the past, the Delta Ditch Run has attracted more than 200 boats with racers from across the country showing up for this generally downwind 65-mile race.

[www.stocktonsc.org](http://www.stocktonsc.org)



## East to West We Have You Covered



Please note our new West Coast  
Office number: **619-215-9106**

  
**PANTAENIUS**  
Yacht Insurance

USA\* · Germany · Great Britain · Monaco  
Denmark · Austria · Spain · Sweden · Australia

\*Pantaenius America Ltd. is a licensed insurance agent licensed in all 50 states. It is an independent corporation, incorporated under the laws of New York and is a separate and distinct entity from any entity of the Pantaenius Group.

## YOUTH SAILING

continued from page 58

### STOCKTON SAILING CLUB

[www.stocktonsc.org](http://www.stocktonsc.org)

**Learn to Sail Program**, ages 8-21 (24 if FT student). When: One-week classes, June-August. Boats: Optis and FJs (provided). Cost: Contact club.

**Summer Sleepover Sail Camp** (with RYC & SCYC), [www.sailcamp.org](http://www.sailcamp.org)  
When: July. Boats: El Toros, Optis (limited number of club boats available to rent).  
Cost: Contact club(s). Scholarships available.

### TAHOE COMMUNITY SAILING / TAHOE YC / TAHOE CITY PARKS & RECREATION

TCPUD Recreation Department, (530) 583-3440, ext. 1

**Youth Sailing Program**, ages 6-17. When: June-August, Monday-Thursday, 10-4.

**Race Program**, Laser Radial and Pico Race Teams. When: Monday evening and Friday during the day. Boats: CFJs, Picos, Nomad 17s, Lasers, 420s.

**US Sailing Power Boat Safe Boat Handling**

**ADVENTURE SAILING/AQUATICS** Sailing, paddle boarding, environmental ecology, water safety. Cost: Contact above.

### TREASURE ISLAND SAILING CENTER

Travis Lund, (415) 421-2225, [www.tisailing.org](http://www.tisailing.org)

**Harbor Seals**, age 6. Entry level, exploratory program focusing on water-safety and wind/sea awareness. Spring, Summer (Camp), Fall, \$350.

**Explore Sailing**, ages 7-12. Entry level, exploratory program instilling confidence on or near the water, building sailing skills and enhancing respect for a clean ocean. Summer Camp, \$350.

**Beginner Youth**, ages 7-12. Fun introduction to beginner level sailing fundamentals through the excitement of small sailboats. Spring, Fall, \$350; Summer Camp, \$600.

**Intermediate Youth**, ages 7-12. Continuation of small dinghy skills, introducing more subtle boat handling techniques and sailing conditions. Spring, Fall, \$350; Summer Camp, \$600.

**Advanced Youth**, ages 7-12. Introduction to racing and strategy for students with a strong understanding of advanced boat handling. Spring, Fall, \$350; Summer Camp, \$600.

**Explore Teen**, ages 13-18. Exploratory class designed for teens to learn basic dinghy sailing skills and boat safety. Summer Camp, \$350.

**Beginner Teen**, ages 13-18. Further exposure to fundamental sailing skills, while heightening personal reliance and judgment on/off the water. Spring, Fall, \$350; Summer Camp, \$600.

**Intermediate Teen**, ages 13-18. Development of doublehanded small dinghy skills, focusing on collaboration, teamwork and proper boat handling. Spring, Fall, \$350; Summer Camp, \$600.

**Advanced Teen** (ages 13-18): Strategy focused, emphasizing teamwork to tackle the complex components of racing in a doublehanded dinghy. Spring, Fall, \$350; Summer Camp, \$600.

**Junior Big Boat I**, ages 7-12. Developmentally appropriate introduction to keelboat sailing instilling communication and teamwork skills. Spring, Fall, \$350.

**Junior Big Boat II**, ages 13-18. Designed as a diverse platform to challenge both novice and advanced students to learn or apply previous knowledge to big boat sailing. Spring, Fall, \$350.

**Junior Leadership Program Level I**, ages 15-18. Leadership pathway for our oldest junior sailors to build instructor experience and continuing personal sailing skills. Summer Camp, \$300.

**Junior Leadership Program Level II**, ages 15-18. Advancement in our leadership pathway as a Junior Instructor, typically in preparation for Level I certification. Summer Camp, FREE. Youth program scholarships available.

### PACIFIC COAST INTERSCHOLASTIC SAILING ASSOCIATION (PCISA) EVENTS FOR HIGH SCHOOL SAILORS

**January 7-8:** Rose Bowl, PCISA 3/5, USSC/LB  
**January 14:** SCYYRA Shadden Series, SDYC  
**January 15-16:** SCYA Harold Adams Team Race, SDYC  
**February 4-5:** So Cal #4, ABYC  
**February 11-12:** NorCal Divisional #2, PYSF  
**February 25-26:** Golden Bear Regatta, PCISA 4/5, TISC  
**March 11-12:** Gaucho Regatta, PCISA 5/5, SBYC  
**March 25-26:** NorCal 5/6, RYC  
**March 25-26:** SoCal #5, SDYC  
**April 1-2:** NorCal Divisional #3, TISC  
**April 15:** Team Race PCCs-Baker Eliminations, SoCal venue TBA  
**April 22-23:** Gold Pacific Coast Championship, StFYC  
**April 22-23:** Silver Pacific Coast Championship, SoCal venue TBA  
**April 29-30:** Team Race PCCs-Baker Eliminations, SoCal venue TBA  
**May 13-14:** Mallory Trophy ISSA Fleet Race Championship, MASSA  
**May 27-28:** Baker Trophy ISSA Team Race Championship, MISSA  
**Sept.-Dec.:** 2017 Fall Schedule TBA; see [www.pcisa.org](http://www.pcisa.org)

### NATIONAL YOUTH EVENTS

See [www.ussailing.org](http://www.ussailing.org) for US Sailing info and dates.

### PACIFIC COAST COLLEGIATE SAILING CONFERENCE EVENTS

See [www.pccscracing.org](http://www.pccscracing.org) for more information.

# JUNE 2017

→ indicates 2-day races.  
YRA events indicated in bold type.

● indicates full moon.

| S  | M  | T  | W  | Th | F         | S  |
|----|----|----|----|----|-----------|----|
|    |    |    |    | 1  | 2         | 3  |
| 4  | 5  | 6  | 7  | 8  | 9         | 10 |
| 11 | 12 | 13 | 14 | 15 | 16        | 17 |
| 18 | 19 | 20 | 21 | 22 | <b>23</b> | 24 |
| 25 | 26 | 27 | 28 | 29 | 30        |    |

## WEEKDAY & SPECIAL EVENTS

- June 1:**
  - SoCal 300, Santa Barbara YC/SDYC – Santa Barbara to SD
- June 14-18:**
  - Gorge Laser Clinic 1; Pre-Laser Masters Nationals, CGRA
- June 16-18:**
  - Opti Heavy Weather, StFYC – City
- June 17:**
  - CGRA Opening Day
- June 21:**
  - *Summer Solstice – Northern Hemisphere*
- June 23-24:**
  - South Tower Race, SSC – Stockton-City-Stockton
- June 23-25:**
  - Woodies Invitational, StFYC – City
  - Long Beach Race Week, LBVC – Long Beach
  - Trans Tahoe Regatta, TahoeYC – Lake Tahoe
- June 24:**
  - Summer Sailstice
  - Poker Run & Boat Camp, FLYC – Folsom Lake
- June 27-30:**
  - WIND Youth Clinic, CGRA

## SATURDAY

Go for the Gold Regatta, GCYC – Scotts Flat →  
SF Bay Challenge, StFYC – City →  
**YRA OYRA RC's Choice – OC**  
Mercury Series #4, EYC – Estuary  
X-Bay Friendship Regatta, CYC/SBYC – Knox/CB

3

June Invitational, SFYC – OC →  
**YRA CBRA #3, GGYC – City**  
Delta Ditch Run, SSC – RYC to SSC  
Interclub #3, BAMA – SB/Alameda  
Santana 22 Team Racing, SCYC – Santa Cruz  
Moonlight Marathon #1, SeqYC – SB/TI

10

One Design Invitational, CYC – OC →  
Rainbow Regatta, GGYC – City →  
**YRA OYRA Farallones Race, SFYC – Ocean**  
North Bay Series #3/Angel Island Race, VYC – NB  
CHISPA Regatta, EYC – Estuary  
Great SF Schooner Race, SFYC – Knox/Central  
Sir Francis Chichester Race, EYC – SB/Alcatraz  
Race of Champions, SSC – Stockton  
Katherine Eavenson Regatta, FLYC – Folsom Lake  
Spring One Design #3, SCYC – Santa Cruz  
Clear Lake Regatta, El Toros – Clear Lake

17

US Sailing Bemis/Smythe Semifinals, SFYC – OC →  
**YRA Series #2 – SB/Alameda**  
Summer Sailstice Race, ElkYC – Moss Landing  
Sailstice/Small Boat Races #4, EYC – Estuary/SB  
Rear Commodore Race, SYC – Knox to SP Bay  
Silver Eagle, IYC – CB  
Intraclub Race #2, RYC – SH  
H.O. Lind 1-3, TYC – NB

24

## SUNDAY

Go for the Gold Regatta, GCYC – Scotts Flat  
SF Bay Challenge, StFYC – City  
Tri-Island #1, BYC – OC/Alcatraz  
Spring Series #7, SSC – Stockton

4

June Invitational, SFYC – OC

11

One Design Invitational, CYC – OC  
Rainbow Regatta, GGYC – City  
Third Sunday Series #4, PresYC – CB  
Spring Lake Summer Series, Santa Rosa SC  
Around the Pins, LTWYC – Tahoe South Shore

FATHER'S DAY

18

US Sailing Bemis/Smythe Semifinals, SFYC – OC  
Spring SCORE #3, SCYC – Santa Cruz

25



### AT YOUR SERVICE AND BY YOUR SIDE

In addition to the fastest sails, Quantum lofts also offer a broad array of sail maintenance and repair services so you can conquer your next regatta with absolute confidence. From multi-point inspection to sail repair and Precision Recuts, our calling is to problem solve to ensure your program reaches its full potential.

#### Quantum Sails Pacific

1230 Brickyard Cove  
Pt. Richmond, CA 94801  
T 510.234.4334  
E sanfrancisco@quantumsails.com

#### Quantum Sails SoCal

1620 Cowles St.  
Long Beach, CA 90813  
T 562.624.4325  
E socal@quantumsails.com

#### Quantum Sails San Diego

2832 Cannon St.  
San Diego, CA 92106  
T 619.226.2422  
E sandiego@quantumsails.com



quantumsails.com

# MARINA BAY YACHT HARBOR



**SAIL FAST  
HAVE FUN**

**DEEP DRAFT  
RACING BERTHS**  
★ ★ ★ ★  
**CLOSE TO  
BOATYARDS,  
CHANDLERIES,  
RIGGERS AND  
SAIL LOFTS**



**Come Home to Marina Bay**

**CONVENIENT  
ACCESS  
TO THE  
WORLD'S  
BEST  
RACING!**



**Make Marina Bay Your Race Headquarters**

**(510) 236-1013 • www.MarinaBayYachtHarbor.com**

## AMAZING GRACE CHENEY CUP



**CALLING ALL GIRLS!  
NOVEMBER 4TH**

**SERIOUSLY FUN!**



**RICHMOND YACHT CLUB**

richmondyc.org  
510.237.2821  
EMAIL gail.yando@sbcglobal.net

## EL TORO FOR A LIFETIME



*Joc, Chris, Nick and Sam Nash – Four generations sail El Toros.*

### 2017 EL TORO CLASS SCHEDULE

**SENIOR:**

RYC WINTER SERIES .....1/8, 2/5, 3/5  
LAKE MERRITT/ESTUARY .....1/15, 2/11, 3/12  
BIG DINGHY ..... MARCH 11  
BULLSHIP ..... APRIL 22  
FLIGHT OF THE BULLS ..... MAY 13  
FREMONT RELAY ..... MAY 21  
LAKE MERRITT, MAYOR'S CUP ..... JUNE  
CLEAR LAKE ..... JUNE 17-18  
NATIONALS, ALAMEDA SC ..... AUGUST 2-5  
PINECREST WORLDS ..... AUGUST 12-13

STAMPEDE ..... OCTOBER 8  
CORK SCREW ..... OCTOBER 14

**JUNIOR:**

FREMONT SPRING ..... MAY  
LAKE MERRITT MAYOR'S CUP ..... JUNE  
STOCKTON REGIONALS ..... JULY  
NATIONALS, ALAMEDA SC ..... AUGUST 2-5  
FUN REGATTA ..... OCTOBER  
RICHMOND, STAMPEDE ..... OCTOBER 8

91 Waldo Point S-40, Sausalito, CA 94965  
etirya@comcast.net • ggcjnjr@gmail.com

**www.eltoroyra.org • (415) 332-7269**

# JULY 2017

→ indicates 2-day races.

**YRA events indicated in bold type.**

● indicates full moon.

| S  | M  | T  | W  | Th | F  | S  |
|----|----|----|----|----|----|----|
|    |    |    |    |    |    | 1  |
| 2  | 3  | 4  | 5  | 6  | 7  | 8  |
| 9  | 10 | 11 | 12 | 13 | 14 | 15 |
| 16 | 17 | 18 | 19 | 20 | 21 | 22 |
| 23 | 24 | 25 | 26 | 27 | 28 | 29 |
| 30 | 31 |    |    |    |    |    |

## WEEKDAY & SPECIAL EVENTS

### July 1-2:

- WIND Youth Regatta, CGRA

### July 2-5:

- Gorge Laser Clinic 2; Pre-Laser Masters Nationals, CGRA

### July 4:

- Independence Day
- Independence Cup, SFYC – Knox
- Brothers & Sisters Race, TYC – NB
- Fouth of July Regatta, EYC – Estuary

### July 5-11:

- LongPac, SSS – Ocean

### July 6:

- Laser Gorge Blowout, CGRA

### July 7-9:

- Laser Masters US National Championship, CGRA

### July 10-12:

- US Sailing 29er Clinic, CGRA

### July 11-15:

- Gorge Laser Clinic 3, CGRA

### July 14-16:

- Gorge Skiff Regatta, CGRA
- Melges 24 PCCs, StFYC – City

### July 17-22:

- Melges 24 NAs, CGRA

### July 21-23:

- SF Classic & UN Challenge, StFYC – City

### July 28-30:

- Santana 22 Nationals, EYC
- Columbia Gorge One-Design Regatta (CGOD), CGRA

## SATURDAY

Overnight Race to SC or Monterey, ElkYC – Monterey Bay →  
**YRA OYRA Half Moon Bay Race – Ocean**

1

Small Boat Invitational, EYC – Estuary →  
High Sierra Centerboard Regatta, FYC – Huntington Lake →  
South Bay Interclub #4, SBYC – SB/Alameda  
PICYA Lipton Cup, SYC – Knox  
Hart Nunes, SFYC – Raccoon Strait  
Jack and Jill Race, SSC – Stockton  
Santana 22 Team Racing, SCYC – Santa Cruz  
Luna Race, VYC – NB  
Southern Crossing, LTWYC – Tahoe South Shore

8

BAYS/Svendensen's Summer Splash, EYC – Estuary →

Monterey & Back, SCYC – Santa Cruz →  
Bay Bridge Regatta, SBYC – SB/SF →  
High Sierra Keelboat Regatta, FYC – Huntington Lake →

**YRA Westpoint Regatta, SeqYC – Central/SB**  
Fox Hat Race, TYC – CB/NB  
Twin Island Race #2, SYC – Knox/Alcatraz  
Plastic Classic, BVBC – SB/SF  
Small Boat Races #5, EYC – Estuary  
Midnight Moonlight Maritime Marathon, SFYC – Raccoon to Carquinez & back  
Championship Series #3, CYC – Knox  
Summer Series #1, ElkYC – Moss Landing

15

J/105 Fleet 1 Invitational, SYC – West Alcatraz/ Knox →  
SC Multihulls, SCYC – Santa Cruz →  
**YRA Series #3, SBYC – SB/SF**  
North Bay #4, VYC – NB  
Centerboard Regatta, FLYC – Folsom Lake

22

**YRA 2nd Half Opener, EYC – CB/Bonita** →  
PICYA Youth Regatta, SeqYC/BAYS →  
Mitchell/Ross Regatta, SFYC – Knox  
Garwoods Regatta, Tahoe YC – Lake Tahoe  
Summer Series #2, ElkYC – Moss Landing

29

## SUNDAY

Return Race to Moss Landing, ElkYC – Monterey Bay

2

Small Boat Invitational, EYC – Estuary  
High Sierra Centerboard Regatta, FYC – Huntington Lake  
Tri-Island Race #2, BYC – OC/TI

9

BAYS/Svendensen's Summer Splash, EYC – Estuary

Monterey & Back, SCYC – Santa Cruz  
Bay Bridge Regatta, SBYC – SB/SF  
High Sierra Keelboat Regatta, FYC – Huntington Lake

Third Sunday Series #5, PresYC – CB  
Spring Lake Summer Series, Santa Rosa SC  
Howard Stevens Race, LTWYC – Tahoe South Shore

16

J/105 Fleet 1 Invitational, SYC – West Alcatraz/ Knox  
SC Multihulls, SCYC – Santa Cruz  
Doublehanded Races, LTWYC – Tahoe South Shore

23

**YRA 2nd Half Opener, EYC – SB**  
PICYA Youth Regatta, SeqYC/BAYS

30

33rd  
Annual

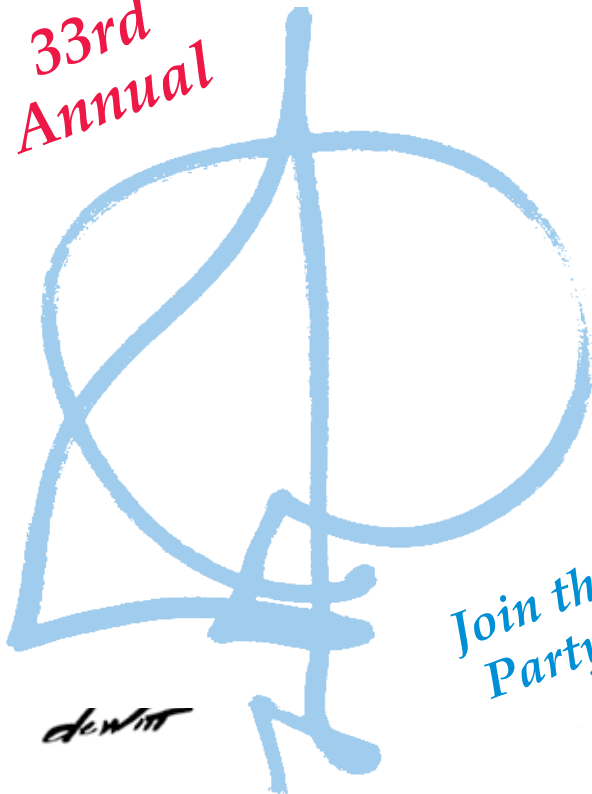

Join the  
Party!

THE BAY VIEW BOAT CLUB AND THE ISLANDER BAHAMA FLEET  
invite all

# '60s, '70s & '80s Vintage Fiberglass Sailboats

to the  
San Francisco

# PLASTIC CLASSIC

REGATTA

and

Concours d'Elegance

**Saturday, July 15**

at the Bay View Boat Club and the waters of Pier 54.

Visit our website: [www.bvbc.org](http://www.bvbc.org)

Bay View Boat Club, 489 Terry Francois Blvd., San Francisco, CA 94158

[www.plasticclassic.com](http://www.plasticclassic.com)

# VHF RADIO CHANNEL USES

| CH. #                                      | INTENDED USE                                                                                                                                                                                                                    |
|--------------------------------------------|---------------------------------------------------------------------------------------------------------------------------------------------------------------------------------------------------------------------------------|
| 16                                         | <b>Distress, safety</b> , calling. Monitored by the Coast Guard and public coast stations.                                                                                                                                      |
| 6                                          | Intership safety purposes and search and rescue (SAR) communications. Not to be used for non-safety matters.                                                                                                                    |
| 12                                         | Offshore Vessel Movement Reporting System. In use from Pilot Boarding Precautionary Area Approach buoys N, W and S to outer limits of System (N 41 nm, W 29 nm, S29 nm).                                                        |
| 13                                         | Bridge to Bridge commercial vessel navigation and safety communications. In use from the Offshore Pilot Boarding Precautionary Area (buoy SF #1 – Sea Buoy) to inside the Bay and throughout the Delta regions.                 |
| 14                                         | Vessel Traffic Service (VTS). Power Driven Vessels (40+ meters), Passenger Vessels (50+ passengers), Towing Vessels (8+ meters w/tow), Marine Events (committee boat, organizer). Check in, <b>MONITOR</b> , update, check out. |
| 22A                                        | U.S. Coast Guard Communications with USCG stations, vessels and aircraft after contact on channel 13 or 16.                                                                                                                     |
| 7A, 8, 9, 10, 11, 18A, 19A, 79A, 80A, 88A  | Port Operations. Commercial (intership and ship to coast) working channel. Commercial vessel business and operational needs.                                                                                                    |
| 9, 68, 69, 71, 72, 77A, 78A                | Port Operations. Commercial (intership and ship to coast) working channel. Supplies, repairs, berthing, yacht harbors, marinas. These are the channels used by race committees.                                                 |
| 26, 84, 87, 27, 28, 86, 25, 26, 27, 28, 28 | <b>Marine Radio-Telephone Operators</b><br>San Francisco<br>Sacramento, Stockton, Delta<br>North: Bodega Bay to Fort Bragg and 50 miles out<br>South: Santa Cruz to Point Sur and 50 miles out                                  |
| 12, 20, 65A, 66A, 73, 74                   | Coast Guard Port Operations. Traffic advisory for use by agencies directing movements of vessels in or near ports. Offshore Vessel Movement Reporting System.                                                                   |
| WX 1-2-3                                   | Weather (receive only).                                                                                                                                                                                                         |

Of all the safety equipment on your boat, your VHF radio is probably the most effective and essential. Because VHF uses common frequencies, it's important to remember a few rules of marine radio etiquette:

- Radio checks, which should be performed at least every time you leave your slip, should always be conducted on channel 9, never on channel 16.
- Before hailing another station on channel 16, listen for at least one minute before keying your mic, so as not to “step” on radio traffic that’s already underway.
- Speak slowly and pause for at least a minute between hailing attempts.
- Always start on the “low” power setting.
- Don’t use the radio if you have non-emergency traffic that can be accomplished with a mobile phone.



**CHALLENGE  
SAILCLOTH**

Technical Innovation for  
Modern Performance

[www.challengesailcloth.com](http://www.challengesailcloth.com)



# AUGUST 2017

→ indicates 2-day races.  
YRA events indicated in bold type.

● indicates full moon.

| S  | M         | T  | W  | Th | F  | S  |
|----|-----------|----|----|----|----|----|
|    |           | 1  | 2  | 3  | 4  | 5  |
| 6  | 7         | 8  | 9  | 10 | 11 | 12 |
| 13 | 14        | 15 | 16 | 17 | 18 | 19 |
| 20 | <b>21</b> | 22 | 23 | 24 | 25 | 26 |
| 27 | 28        | 29 | 30 | 31 |    |    |

## WEEKDAY & SPECIAL EVENTS

- August 2-5:**
  - US Windsurfer National Championships, BYC – OC East & South
- August 2-6:**
  - Finn Nationals, EYC – SB/Estuary
- August 5:**
  - Double Damned, HRYC
- August 9:**
  - Hannig Cup Race, SeqYC – SB
- August 18-20:**
  - RS Aero PCCs, CGRA
  - Aldo Alessio Perpetual, StFYC – City
  - International 14 North Americans, RYC – SH
- August 24-27**
  - J/111 Worlds, StFYC – City
- Aug. 27-Sept. 1:**
  - International Folkboat Regatta, CYC – Knox
- August 31:**
  - Ronstan Bridge to Bridge, StFYC – City

## SATURDAY

Summer Keel, SFYC – OC →  
**YRA Series #4, RYC – SH**  
Moseley Regatta, TYC – NB  
Moonlight Marathon #2, SeqYC – SB/TI

5

**YRA OYRA Drake's Bay, CYC – Ocean →**  
Steele Cup/Dinghy Weekend, FLYC – Rancho Seco →  
BAYS #4 Youth Regatta, SFYC – Richardson Bay →  
Interclub #5, EYC – SB/SF  
Santana 22 Team Racing, SCYC – Santa Cruz  
Summer #3, SeqYC – SB  
Summer Series #3, ElkYC – Moss Landing

12

Round the Rock, BVBC – SB/SF  
CBRA Invitational #2, SYC – West Alcatraz  
Small Boat Races #6, EYC – Estuary  
North Bay Series #5, VYC – NB  
H.O. Lind 4-6, TYC – NB  
Wosser Cup, SFYC – Knox  
Championship Series #4, CYC – Knox  
Fall One Design #1, SCYC – Santa Cruz  
Singlehanded Regatta, FLYC – Folsom Lake

19

Optimist PCCs, SFYC – OC →  
**YRA OYRA RC's Choice – Ocean**  
Intraclub Race #3, RYC – SH  
Double Angle, ElkYC/SCYC – Monterey Bay  
Singlehanded/Doublehanded #5, SeqYC – SB  
Women Skippers Regatta, SYC – Knox

26

## SUNDAY

Summer Keel, SFYC – OC  
**YRA CBRA #4, CYC – CB**  
Commodore's Cup Race, LTWYC – Tahoe South Shore

6

**YRA OYRA Drake's Bay, CYC – Ocean**  
Steele Cup/Dinghy Weekend, FLYC – Rancho Seco  
BAYS #4 Youth Regatta, SFYC – Richardson Bay  
Tri-Island Race #3, BYC, OC/Angel  
Big Brothers Big Sisters Regatta, SCYC – Santa Cruz  
Lady's Day Race, LTWYC – Tahoe South Shore

13

Gracie & George Regatta, EYC – SB/Estuary  
Third Sunday Series #6, PresYC – CB  
Spring Lake Summer Series, Santa Rosa SC  
Singlehanded Races, LTWYC – Tahoe South Shore

20

Optimist PCCs, SFYC – OC  
Fall SCORE #1, SCYC – Santa Cruz

27

# South Beach Yacht Club 2017 Racing Season



**For the best sailing on the South Bay, come race with SBYC!**

### All Boats Welcome

One Design Starts Available (minimum entry requirements)

Post-race activities include BBQ & no-host bar.  
Prizes awarded for all divisions.

Racing contact:  
rearcommodore@southbeachyachtclub.org

or visit our Web site at:

**www.southbeachyachtclub.org**

South Beach Yacht Club  
Pier 40 on the Embarcadero  
San Francisco



### 2017 Island Fever Races:

**1/28, 2/25, 3/18, 11/18, 12/16**

**Friday Night Series: April 21–August 25**

**SBYC/CYC/SYC X-Bay Regatta: June 3**

**SBYC Bay Bridge Regatta: July 15-16**

**Jazz Cup: September 2**

**Herb Meyer Regatta: September 23-24**

**Red Bra Regatta: October 21**

Winter  
California  
Style

## BERKELEY MIDWINTERS

Where the heat is  
on all winter long!

The longest running  
winter series on the Bay.

### New set-marks to avoid shallow water!

Separate Saturday and  
Sunday series!

Second weekend of the month  
from November through February!



Enter them both and use the  
BYC guest dock overnight.

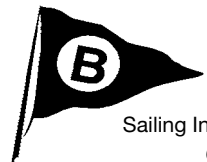

Check out [www.berkeleyyc.org](http://www.berkeleyyc.org)  
for Notice of Race, Entry Form,  
Sailing Instructions, results and much, much more.  
Call or email for more information

**Bob Gray**  
(510) 530-4162  
[r\\_gray40@sbcglobal.net](mailto:r_gray40@sbcglobal.net)

**Bobbi Tosse**  
(925) 939-9885  
[bobbi@jfcbat.com](mailto:bobbi@jfcbat.com)



One of Carl Schumacher's breakthrough designs,  
the Express 37 has been one of the most successful  
one-design fleets on the Bay for over 25 years.

Contact:  
Dave Fullerton  
**(650) 458-3324**  
[www.express37.net](http://www.express37.net)

Join us for our  
**27<sup>th</sup> ROLEX  
BIG BOAT SERIES  
& 32<sup>nd</sup> NATIONAL  
CHAMPIONSHIP  
REGATTA**

# SANTANA

JOIN US FOR  
THE 2017  
S22 NATIONALS  
July 21-23  
ENCINAL YC



[www.santana22.org](http://www.santana22.org)

- ◆ Tight, tactical one design racing
- ◆ Mentor program for new members
- ◆ New boats now in production, but old boats just as fast
- ◆ Non-spinnaker and spinnaker races, cruise-ins and parties
- ◆ The best bang for the buck on the Bay!

co-fleet captains Kristen Soetebier & Deb Fehr  
**[Santana22sfbay@gmail.com](mailto:Santana22sfbay@gmail.com)**

JOIN US

# 36

Islander 36 Association

*Fun Racing, Comfortable Cruising,  
Great Friends, Active One-Design Fleet.*



Spring Meeting, March 18, Golden Gate YC

Curious? Visit: [www.islander36.org](http://www.islander36.org)

Racer? Fleet Captain Eric Mueller - [racing@islander36.org](mailto:racing@islander36.org)  
Cruiser? Cruise Captain Bob DaPrato - [cruising@islander36.org](mailto:cruising@islander36.org)

# SEPTEMBER 2017

☉ indicates full moon.

→ indicates 2-day races. **YRA events indicated in bold type.**

| S  | M  | T  | W  | Th | F  | S  |
|----|----|----|----|----|----|----|
|    |    |    |    |    | 1  | 2  |
| 3  | 4  | 5  | 6  | 7  | 8  | 9  |
| 10 | 11 | 12 | 13 | 14 | 15 | 16 |
| 17 | 18 | 19 | 20 | 21 | 22 | 23 |
| 24 | 25 | 26 | 27 | 28 | 29 | 30 |

| WEEKDAY & SPECIAL EVENTS                                                                                                                                                                                                                                                                                                                                                                                                                                                                                                                                                                       | SATURDAY                                                                                                                                                                                                                                                                                                                                                                                                                                                                                                      | SUNDAY                                                                                                                                                                                                                                                                                                                                                                  |
|------------------------------------------------------------------------------------------------------------------------------------------------------------------------------------------------------------------------------------------------------------------------------------------------------------------------------------------------------------------------------------------------------------------------------------------------------------------------------------------------------------------------------------------------------------------------------------------------|---------------------------------------------------------------------------------------------------------------------------------------------------------------------------------------------------------------------------------------------------------------------------------------------------------------------------------------------------------------------------------------------------------------------------------------------------------------------------------------------------------------|-------------------------------------------------------------------------------------------------------------------------------------------------------------------------------------------------------------------------------------------------------------------------------------------------------------------------------------------------------------------------|
| <p><b>Aug. 27-Sept. 1:</b> • International Folkboat Regatta, CYC – Knox</p> <p><b>Sept. 1-2:</b> • Windjammers, StFYC/SCYC – SF to Santa Cruz</p> <p><b>Sept. 1-4:</b> • 65th Annual Labor Day Regatta, SRSC – Tomales Bay</p> <p><b>Sept. 4:</b> • Labor Day – Take a worker sailing</p> <p><b>Sept. 14-17:</b> • Rolex Big Boat Series, StFYC – City</p> <p><b>Sept. 17-18:</b> • Bart's Bash SF Bay, GGYC – City</p> <p><b>Sept. 22:</b> • Autumnal Equinox</p> <p><b>Sept. 23-24:</b> • Women's Sailing Seminar, IYC – Estuary</p> <p><b>Sept. 25-30:</b> • Etchells Worlds, SFYC – OC</p> | <p>Labor Day Regatta, Stillwater Cove YC – Stillwater Cove →</p> <p><b>YRA CBRA #5, BYC – OC</b></p> <p>Jazz Cup, SBYC/BenYC – CB to Benicia</p> <p style="text-align: right;"><b>2</b></p>                                                                                                                                                                                                                                                                                                                   | <p>Labor Day Regatta, Stillwater Cove YC – Stillwater Cove</p> <p style="text-align: right;"><b>3</b></p>                                                                                                                                                                                                                                                               |
|                                                                                                                                                                                                                                                                                                                                                                                                                                                                                                                                                                                                | <p>Millimeter Nationals #1, EYC – Estuary →</p> <p>Multihull Regatta, RYC – SH →</p> <p>Perpetual Day 1, LTWYC – Tahoe South Shore →</p> <p><b>YRA OYRA Jr. Waterhouse, RYC – Ocean</b></p> <p>Tornberg Regatta, TYC – NB</p> <p>Fall Race #1, SSC – Stockton</p> <p>CBRA Invitational #3, SYC – West Alcatraz/Knox</p> <p>Interclub #6, OYC – SB/Alameda</p> <p>Santana 22 Team Racing, SCYC – Santa Cruz</p> <p>Interclub Challenge (Barth Race), SeqYC – SB</p> <p style="text-align: right;"><b>9</b></p> | <p>Millimeter Nationals #2, EYC – Estuary</p> <p>Multihull Regatta, RYC – SH</p> <p>Perpetual Day 2, LTWYC – Tahoe South Shore</p> <p>Commodore's Cup, EYC – Estuary</p> <p>Governor's Cup Series #1, FLYC – Folsom Lake</p> <p style="text-align: right;"><b>10</b></p>                                                                                                |
|                                                                                                                                                                                                                                                                                                                                                                                                                                                                                                                                                                                                | <p>Easom Founders, SFYC – OC →</p> <p>Fall One Design #2, SCYC – Santa Cruz</p> <p>Half Moon Bay Race, SSS – Ocean</p> <p>Island Fever #2, SBYC – SB/SF</p> <p>Summer #4, SeqYC – SB</p> <p style="text-align: right;"><b>16</b></p>                                                                                                                                                                                                                                                                          | <p>Easom Founders, SFYC – OC</p> <p>Small Boat Races #7, EYC – Estuary</p> <p>Tomales Bay Series, Santa Rosa SC – Marconi Cove</p> <p>Late Summer Race, LTWYC – Tahoe South Shore</p> <p>Governor's Cup Series #2, FLYC – Folsom Lake</p> <p>Third Sunday Series #7, PresYC – CB</p> <p style="text-align: right;"><b>17</b></p>                                        |
|                                                                                                                                                                                                                                                                                                                                                                                                                                                                                                                                                                                                | <p>Herb Meyer Regatta, SBYC – SB/SF →</p> <p>California Offshore Race, RYC – Ocean →</p> <p>Totally Dinghy, RYC – SH →</p> <p><b>YRA CBRA #6, StFYC – OC</b></p> <p>North Bay Series #6, VYC – NB</p> <p>Singlehanded/Doublehanded #6/Commodore's Cup, SeqYC – SB</p> <p>Jack &amp; Jill, SCYC – Santa Cruz</p> <p>Joe Logan Regatta, StFYC – SF</p> <p style="text-align: right;"><b>23</b></p>                                                                                                              | <p>Herb Meyer Regatta, SBYC – SB/SF</p> <p>California Offshore Race, RYC – Ocean</p> <p>Totally Dinghy, RYC – SH</p> <p>Governor's Cup Series #3, FLYC – Folsom Lake</p> <p>Women's Sailing Seminar Regatta, IYC – Estuary</p> <p>Fall SCORE #2, SCYC – Santa Cruz</p> <p>Fannette Isle Race, LTWYC – Tahoe South Shore</p> <p style="text-align: right;"><b>24</b></p> |
|                                                                                                                                                                                                                                                                                                                                                                                                                                                                                                                                                                                                | <p><b>YRA Season Closer, CYC – CB →</b></p> <p>SF Cup/Catalina 34 Fleet, SBYC – SB/SF →</p> <p>Shorthanded Races, TYC – NB</p> <p>Champions Race, BenYC – Carquinez</p> <p style="text-align: right;"><b>30</b></p>                                                                                                                                                                                                                                                                                           |                                                                                                                                                                                                                                                                                                                                                                         |
|                                                                                                                                                                                                                                                                                                                                                                                                                                                                                                                                                                                                |                                                                                                                                                                                                                                                                                                                                                                                                                              |                                                                                                                                                                                                                                                                                                                                                                         |

# BOAT LOANS

from  

**Trident Funding**

*"a fresh approach from people you can trust"*

**JOAN BURLEIGH**  
**(800) 690-7770**

Loans will be arranged or made pursuant to a California Finance Lenders License #605 1871.

---

## WOMEN'S CIRCUIT

The events on this page constitute *Latitude 38's* unofficial Women's Circuit. We challenge women sailors to take the helm and create their own series of events from this list. You don't need to finish first to win, and you don't need to do all the races on the list either! Just send proof of your participation in as many events as you can to [chris@latitude38.com](mailto:chris@latitude38.com), or fax it to (415) 383-5816, by November 10, 2017, and you could be crowned *Latitude's* 'Queen of the Women's Circuit'.

### SUNDAY, MARCH 5

Sadie Hawkins Race, IYC  
John New, (510) 521-2980, [iycracing@iyc.org](mailto:iycracing@iyc.org),  
[www.iyc.org](http://www.iyc.org)

### SATURDAY, MARCH 11

Rites of Spring (division for all-female crews), OYC  
Jim Hild, (510) 277-4676, [oyracecom@gmail.com](mailto:oyracecom@gmail.com),  
[www.oaklandyachtclub.com](http://www.oaklandyachtclub.com)

### SATURDAY, MARCH 18

Doublehanded Farallones, Double Dame Division  
(650) 394-6343, [DHF2017@sfbama.org](mailto:DHF2017@sfbama.org), [www.sfbama.org](http://www.sfbama.org)

### SATURDAY, MAY 20

Lady and the Tramp Race, FLYC  
[www.flyc.org](http://www.flyc.org)

### SATURDAY, JULY TBD

Sadie Hawkins, KBSC  
Check website for information: [www.kbsail.com](http://www.kbsail.com)

### SATURDAY, JULY 8

Jack and Jill Race, SSC  
(209) 951-5600, [regatta16@stocktonsc.org](mailto:regatta16@stocktonsc.org),  
[www.stocktonsc.org](http://www.stocktonsc.org)

### SUNDAY, AUGUST 13

Lady's Day Race, LTWYC  
David Young, (530) 545-9155, [sierrasailor@gmail.com](mailto:sierrasailor@gmail.com)

### SUNDAY, AUGUST 20

Gracie & George Regatta, EYC  
Theo Rohr, (510) 205-2451  
[rearcommodore@encinal.org](mailto:rearcommodore@encinal.org), [www.encinal.org](http://www.encinal.org)

### SATURDAY, AUGUST 26

Women Skippers Regatta  
SYC (organized by SYC Auxilliary)  
(415) 332-7400, [www.sausalitoyachtclub.org](http://www.sausalitoyachtclub.org)

### SUNDAY, SEPTEMBER TBD

Jack & Jill, KBSC  
Check website for information: [www.kbsail.com](http://www.kbsail.com)

### SATURDAY, SEPTEMBER 23

Jack and Jill Regatta, SCYC  
[info@scyc.org](mailto:info@scyc.org), [www.scyc.org](http://www.scyc.org)

### SATURDAY & SUNDAY, SEPTEMBER 23-24

Women's Sailing Seminar  
(race Sunday), IYC, John New, (510) 521-2980,  
[iycracing@iyc.org](mailto:iycracing@iyc.org), [www.iyc.org](http://www.iyc.org)

### SATURDAY, OCTOBER 14

Joan Storer Regatta, TYC  
Cam Tuttle, (415) 789-9294  
[race@tyc.org](mailto:race@tyc.org), [www.tyc.org](http://www.tyc.org)

### SATURDAY, OCTOBER 21

Red Bra Regatta, SBYC  
Mike Satterlund, (408) 839-4149  
[rearcommodore@southbeachyachtclub.org](mailto:rearcommodore@southbeachyachtclub.org),  
[www.southbeachyachtclub.org](http://www.southbeachyachtclub.org)

### SATURDAY, NOVEMBER 4

Amazing Grace Cheney Cup  
Gail Yando, [gail.yando@sbcglobal.net](mailto:gail.yando@sbcglobal.net)  
[www.richmondyc.org](http://www.richmondyc.org)

### SUNDAY, NOVEMBER 5

Jack & Jill + 1  
(woman skipper triplehanded race), IYC  
John New, (510) 521-7442,  
[iycracing@iyc.org](mailto:iycracing@iyc.org), [www.iyc.org](http://www.iyc.org)



Jennifer McKenna (left), the 2016 Queen of the Women's Circuit and a member of RYC, raced in SYC's Women Skippers Regatta in August, TYC's Joan Storer and RYC's Amazing Grace Cheney Regatta in October, and IYC's Jack & Jill + 1 in November. Jennifer was crowned by the reigning queen and fellow Santana 22 sailor, Deb Fehr (right).

# OCTOBER 2017

→ indicates 2-day races.

**YRA events indicated in bold type.**

● indicates full moon.

| S  | M  | T  | W  | Th | F  | S  |
|----|----|----|----|----|----|----|
| 1  | 2  | 3  | 4  | 5  | 6  | 7  |
| 8  | 9  | 10 | 11 | 12 | 13 | 14 |
| 15 | 16 | 17 | 18 | 19 | 20 | 21 |
| 22 | 23 | 24 | 25 | 26 | 27 | 28 |
| 29 | 30 | 31 |    |    |    |    |

## WEEKDAY & SPECIAL EVENTS

- October 2-9:** • Fleet Week
- October 9:** • Columbus Day
- October 30:** • Baja Ha-Ha starts, SD to Cabo
- October 31:** • Halloween: Go sailing in costume!



## SATURDAY

## SUNDAY

Sportfest Invitational, RYC – OC →  
 Islander 36 Nationals, GGYC – City  
 Auxiliary Cup, SFYC – Knox  
 Champion of Champions, BVBC – SB/SF  
 Fall Series #2, SSC – Stockton  
 Summer #5, SeqYC – SB

7

Sportfest Invitational, RYC – OC  
 Chowder #2, BYC – OC

8

Fall Classic, SFYC – Knox →  
**YRA Championship Regatta, BYC – CB**  
 Oktoberfest, BYC – OC  
 Twin Island Race #3, SYC – Knox/Alcatraz  
 Oktoberfest, OYC – TI/Estuary  
 Champion of Champions, VYC – NB  
 Joan Storer Regatta, TYC – NB  
 Interclub #4, RYC – SH  
 Santana 22 Team Racing, SCYC – Santa Cruz  
 South Bay Championship, SeqYC – SB  
 Corkscrew Slough Regatta, SeqYC – SB  
 Homecoming Regatta, SYC – Sausalito

14

Fall Classic, SFYC – Knox  
 Chowder #3, BYC – OC  
 Tomales Bay Series, Santa Rosa SC –  
 Marconi Cove

15

Vallejo 1, SSS – CB →  
 Leukemia Cup, SFYC – City or Alcatraz →  
 Jessica Cup, StFYC – City  
 Ross Wood CC #5, CYC – Knox  
 Fall One Design #3, SCYC – Santa Cruz  
 Red Bra Regatta, SBYC – SB/SF side

21

Vallejo 2, SSS – CB  
 Leukemia Cup, SFYC – Knox  
 Chowder #4, BYC – OC  
 Fall SCORE #3, SCYC – Santa Cruz  
 Spring Lake Winter Series,  
 Santa Rosa SC

22

Great Pumpkin, RYC – OC →  
 Fall Dinghy, StFYC – City →  
 Chowder Cup Series #1, ElkYC – Moss Landing  
 Round the Island, SFYC – Belvedere/TI/SH  
 Red Rock Regatta, TYC – NB

28

Great Pumpkin, RYC – OC  
 Fall Dinghy, StFYC – City  
 Chowder #5, BYC – OC  
 Tomales Bay Series, Santa Rosa SC –  
 Marconi Cove

29

## IT STARTS WITH A FIASCO, AND COULD TAKE YOU TO HAWAII



### SHORTHANDED SAILING IN THE BAY AND THE OCEAN

The Singlehanded Sailing Society has the ideal progression to help you meet the challenge.....

#### 2017 Race Dates:

Three Bridge Fiasco - Jan. 28  
 Corinthian - Mar. 25  
 Round the Rocks - Apr. 15

1 Singlehanded Farallones - May 20  
 56-mile Qualifier for the LONGPAC

2 Great Pacific Longitude Race - "Longpac" - July 5-11  
 400-mile Qualifier for SHTP

Drake's Bay - Aug. 12-13  
 Half Moon Bay - Sept. 16  
 Vallejo 1-2 - Oct. 21-22

3 Singlehanded Transpac - June 2018  
 2,120 miles. Ends in Hanalei Bay, Kauai



**JOIN US IN 2017!**

**Complete SSS schedule: [www.sfbaysss.org](http://www.sfbaysss.org)**

# 2017-2018 PACIFIC OCEAN EVENTS

## HAWAII & SOUTH PACIFIC

### TAHITI PEARL REGATTA • May 23-27, 2017

International fleet racing in the Leeward Islands of Tahiti.  
[www.tahitipearlregatta.org.pf](http://www.tahitipearlregatta.org.pf)

### TAHITI-MOOREA SAILING RENDEZ-VOUS • June 23-25, 2017

with *Latitude 38*. [www.tahiti-moorea-sailing-rdv.com](http://www.tahiti-moorea-sailing-rdv.com)

### TRANSPACIFIC YACHT RACE • July 3-21, 2017

Los Angeles to Tahiti. [www.transpacrace.com](http://www.transpacrace.com)

### SINGLEHANDED TRANSPAC • June 2018

San Francisco to Hanalei Bay, Kauai, Hawaii. [www.sfbaysss.org](http://www.sfbaysss.org)

### VIC-MAUI • July 2018

2,300 miles from Victoria, BC, to Maui, Hawaii. [www.vicmaui.org](http://www.vicmaui.org)

### PACIFIC CUP • July 9, 2018

San Francisco to Kaneohe Bay, Oahu, Hawaii. [www.pacificcup.org](http://www.pacificcup.org)

## MEXICO

### BANDERAS BAY REGATTA • February 28-March 4, 2017

Music, fun and racing specially designed for cruisers on Banderas Bay.  
[www.banderasbayregatta.com](http://www.banderasbayregatta.com)

### NEWPORT TO CABO RACE • March 10-16, 2017

Newport Beach to Cabo San Lucas, Baja California Sur.  
[www.nhyccaborace.com](http://www.nhyccaborace.com)

### LA PAZ BAY FEST FOR CRUISERS • March 29-April 2, 2017

Club Cruceros de La Paz. [www.clubcruceros.net](http://www.clubcruceros.net)

### NEWPORT TO ENSENADA • April 28-30, 2017

Newport Beach to Ensenada, Baja California.  
[www.newporttoensenada.com](http://www.newporttoensenada.com)

### PV RACE • February 2018

1,100-mile slide from San Diego to Puerto Vallarta. [www.sdy.com/pv](http://www.sdy.com/pv)

## AUSTRALIA, NEW ZEALAND & UK

### BAY OF ISLANDS SAILING WEEK • January 25-27, 2017

Buoy racing in New Zealand's Bay of Islands.  
[www.bayofislandssailingweek.org.nz](http://www.bayofislandssailingweek.org.nz)

### COWES WEEK • July 29-August 5, 2017

One of the UK's longest running and most successful sporting events.  
[www.cowesweek.co.uk](http://www.cowesweek.co.uk)

## AUSTRALIA, NEW ZEALAND & UK cont'd

### AUDI HAMILTON ISLAND RACE WEEK • August 19-26, 2017

Racing and partying in Australia's Whitsunday Islands.  
[www.hamiltonislandraceweek.com.au](http://www.hamiltonislandraceweek.com.au)

### COASTAL CLASSIC AUCKLAND TO RUSSELL YACHT RACE

Late October 2017

Point to point race from Auckland to Russell in N.Z.'s Bay of Islands. [www.coastalclassic.co.nz](http://www.coastalclassic.co.nz)

### ROLEX SYDNEY HOBART YACHT RACE • December 2017

World's preeminent middle-distance race – 628 miles from Sydney Harbour to the Derwent River, Australia.  
[www.rolexsydneyhobart.com](http://www.rolexsydneyhobart.com)

## ASIA

### ROYAL LANGKAWI INTERNATIONAL REGATTA • January 9-14, 2017

Large buoy racing regatta for everything from IRC divisions to multihulls.  
[www.langkawiregatta.com](http://www.langkawiregatta.com)

### SUBIC BAY TO BORACAY RACE • February 18-24, 2017

200-mile race from Subic Bay to Boracay, Philippines.  
[www.subicsailing.com](http://www.subicsailing.com)

### BORACAY CUP REGATTA • Late February 2017

Following the offshore race from Subic Bay, the Boracay Cup gets underway with four days each of windward/leeward and long-distance races. [www.subicsailing.com](http://www.subicsailing.com)

### CHINA CUP INTERNATIONAL REGATTA • October/November 2017

The regatta kicks off with a passage race from Hong Kong to Shenzhen, followed by three days of inshore racing in and around Shenzhen's Daya Bay.  
[www.chncup.com](http://www.chncup.com)

### PHUKET KING'S CUP • Early December 2017

Asia's premier yachting event.  
[www.kingscup.com](http://www.kingscup.com)

### ROLEX CHINA SEA RACE • March 28, 2018

565-mile race from Hong Kong to Subic Bay, Philippines.  
[www.rhky.com.hk/rolexchinasearace.aspx](http://www.rhky.com.hk/rolexchinasearace.aspx)



# PACIFIC CUP

the FUN race to Hawaii • July 2018

## THE TIME TO START IS NOW 20TH EDITION

- Seminars
- Offshore Academy
- Safety at Sea
- Pacific Cup Village before the start
- First Start July 9th, 2018

[www.PacificCup.org](http://www.PacificCup.org)

# NOVEMBER 2017

● indicates full moon.

→ indicates 2-day races. **YRA events indicated in bold type.**

| S  | M  | T  | W  | Th | F  | S  |
|----|----|----|----|----|----|----|
| 5  | 6  | 7  | 8  | 9  | 10 | 11 |
| 12 | 13 | 14 | 15 | 16 | 17 | 18 |
| 19 | 20 | 21 | 22 | 23 | 24 | 25 |
| 26 | 27 | 28 | 29 | 30 |    |    |

## WEEKDAY & SPECIAL EVENTS

- November 4:**
  - Turkey Shoot, LWSC – Lake Washington
- November 11:**
  - Veterans Day. Take a veteran sailing!*
- November 21:**
  - YRA Year-End Trophy Party – BYC**
- November 23:**
  - Thanksgiving Day
- November 24:**
  - Wild Turkey Race, TYC – NB

## SATURDAY

BAYS HS NorCal Regatta, EYC – Estuary →  
 Opti Winter #1, SFYC – Richardson Bay →  
 Cal 20 Round Robin, CYC – Raccoon Strait →  
 Seaweed Soup Midwinter #1, GGYC – City  
 Amazing Grace Cheney Cup, RYC – SH  
 Winter #1, SeqYC – SB  
 Monterey Inv'l/Perry Cup #1, MPYC – Monterey  
 Pt. Fermin Inverted Start, CBYC – San Pedro  
 Fall Race #3, SSC – Stockton

4

## SUNDAY

BAYS HS NorCal Regatta, EYC – Estuary  
 Opti Winter #1, SFYC – Richardson Bay  
 Cal 20 Round Robin, CYC – Raccoon Strait  
 Jack & Jill + 1, IYC – Estuary  
 Midwinter #1, SYC – Knox  
 Chowder #6, BYC – OC  
 Laser Short Course, RYC

DAYLIGHT SAVING TIME ENDS

5

Midwinter #1, BYC – OC  
 RegattaPRO Winter One Design Invitational #1,  
 SYC – OC/SH  
 Santana 22 Team Racing, SCYC – Santa Cruz  
 Chowder Cup #2, ElkYC – Moss Landing  
 Fall One Design Regatta, CBYC –  
 San Pedro

11

Midwinter #2, BYC – OC  
 Island Days Midwinter #1, IYC – Estuary  
 Spring Lake Winter Series, Santa Rosa SC

12

Turkey Day Regatta, ABYC – Alamos Bay →  
 Jack Frost #1, EYC – Estuary  
 Tiny Robbins Midwinter Series #1, VYC – NB  
 Midwinter #1, SCYC – Santa Cruz  
 Island Fever #1, SBYC – SB/SF  
 Redwood Cup #1, SeqYC – SB

18

Turkey Day Regatta, ABYC – Alamos Bay  
 Commodore's Challenge, IYC – Estuary  
 Chowder #7, BYC – OC

19

Chowder Cup #3, ElkYC – Moss Landing

25

Chowder #8, BYC – OC

26

CHRIS RAY / WWW.CRAYIUP.COM



# PERFORMANCE RIGGING

Wire and Rod Standing Rigging • Running Rigging  
 Architectural Rigging

*Offshore / Inshore  
 High performance rigging  
 and deck layouts.*

**BUTLER RIGGING**  
 butlerrigging@sbcglobal.net  
 (510) 672-2639

BSI RIGGING • NEW ENGLAND ROPES • SCHAEFER

**Robichaud Batten Systems USA**



**Quality.  
Durability.  
Performance.**



Trusted and preferred by  
these Bay Area Sail Makers:

**North Sails   Quantum Sails  
Pineapple Sails   Doyle Sails  
Hogin Sails   Ullman Santa Cruz  
UK-Halsey Sails   Pegasus Racing**

Visit us at [www.rbsbattens.com](http://www.rbsbattens.com)  
for more info on new products.

**LOOK  
GOOD...  
SAIL  
FAST!**



***(We'll handle the first part!)***  
**10% Discount for scheduling 30+ days in advance**  
(Due to high demand prior to big events,  
we've been unable to accommodate everyone.)



**Westwind**  
Washing, waxing, varnishing, and interior cleaning.  
*Serving the entire Bay Area for more than 25 years*

Pier 40, South Beach on the Embarcadero • San Francisco  
**(415) 661-2205 • [www.boatdetailing.com](http://www.boatdetailing.com)**

## 2017 SUNRISE AND SUNSET

As observed from sea level at the Golden Gate Bridge

Pacific Standard Time  
Corrected for Daylight Saving Time

|                 | RISE | SET   |                  | RISE | SET   |
|-----------------|------|-------|------------------|------|-------|
| <b>JANUARY</b>  |      |       | <b>JULY</b>      |      |       |
| 1               | 7:25 | 17:02 | 5                | 5:54 | 20:35 |
| 5               | 7:25 | 17:05 | 10               | 5:57 | 20:33 |
| 10              | 7:25 | 17:10 | 15               | 6:00 | 20:31 |
| 15              | 7:24 | 17:15 | 20               | 6:04 | 20:28 |
| 20              | 7:22 | 17:20 | 25               | 6:08 | 20:24 |
| 25              | 7:20 | 17:26 | 30               | 6:12 | 20:20 |
| 30              | 7:15 | 17:31 | <b>AUGUST</b>    |      |       |
| <b>FEBRUARY</b> |      |       | 5                | 6:17 | 20:14 |
| 5               | 7:10 | 17:38 | 10               | 6:21 | 20:08 |
| 10              | 7:05 | 17:44 | 15               | 6:26 | 20:02 |
| 15              | 6:59 | 17:49 | 20               | 6:30 | 19:55 |
| 20              | 6:53 | 17:54 | 25               | 6:34 | 19:48 |
| 25              | 6:46 | 18:00 | 30               | 6:38 | 19:41 |
| <b>MARCH</b>    |      |       | <b>SEPTEMBER</b> |      |       |
| 5               | 6:35 | 18:08 | 5                | 6:43 | 19:32 |
| 10              | 6:28 | 18:12 | 10               | 6:48 | 19:25 |
| 15              | 7:20 | 19:17 | 15               | 6:52 | 19:17 |
| 20              | 7:13 | 19:22 | 20               | 6:56 | 19:09 |
| 25              | 7:05 | 19:27 | 25               | 7:00 | 19:01 |
| 30              | 6:57 | 19:31 | 30               | 7:05 | 18:54 |
| <b>APRIL</b>    |      |       | <b>OCTOBER</b>   |      |       |
| 5               | 6:48 | 19:37 | 5                | 7:09 | 18:46 |
| 10              | 6:41 | 19:41 | 10               | 7:14 | 18:39 |
| 15              | 6:34 | 19:46 | 15               | 7:18 | 18:32 |
| 20              | 6:27 | 19:50 | 20               | 7:23 | 18:25 |
| 25              | 6:21 | 19:55 | 25               | 7:28 | 18:19 |
| 30              | 6:15 | 20:00 | 30               | 7:33 | 18:13 |
| <b>MAY</b>      |      |       | <b>NOVEMBER</b>  |      |       |
| 5               | 6:09 | 20:04 | 5                | 6:40 | 17:06 |
| 10              | 6:04 | 20:09 | 10               | 6:45 | 17:02 |
| 15              | 6:00 | 20:13 | 15               | 6:50 | 16:58 |
| 20              | 5:56 | 20:17 | 20               | 6:56 | 16:55 |
| 25              | 5:53 | 20:21 | 25               | 7:01 | 16:53 |
| 30              | 5:50 | 20:25 | 30               | 7:06 | 16:51 |
| <b>JUNE</b>     |      |       | <b>DECEMBER</b>  |      |       |
| 5               | 5:48 | 20:29 | 5                | 7:10 | 16:51 |
| 10              | 5:47 | 20:31 | 10               | 7:14 | 16:51 |
| 15              | 5:47 | 20:33 | 15               | 7:18 | 16:52 |
| 20              | 5:48 | 20:35 | 20               | 7:21 | 16:54 |
| 25              | 5:49 | 20:36 | 25               | 7:23 | 16:57 |
| 30              | 5:51 | 20:36 | 30               | 7:25 | 17:00 |

This table may be used in the vicinity of the stated location with less than a 2-minute error.

## Latitude 38

### 2017 Sailing Calendar and YRA Master Schedule

|                   |                                                                    |                                                                      |          |
|-------------------|--------------------------------------------------------------------|----------------------------------------------------------------------|----------|
| Publisher         | John Arndt                                                         | <a href="mailto:john@latitude38.com">john@latitude38.com</a>         | ext. 108 |
| Managing Editor   | Andy Turpin                                                        | <a href="mailto:andy@latitude38.com">andy@latitude38.com</a>         | ext. 112 |
| Racing Editor     | Christine Weaver                                                   | <a href="mailto:chris@latitude38.com">chris@latitude38.com</a>       | ext. 103 |
| Advertising Sales | John Arndt                                                         | <a href="mailto:john@latitude38.com">john@latitude38.com</a>         | ext. 108 |
| Advertising Sales | Mitch Perkins                                                      | <a href="mailto:mitch@latitude38.com">mitch@latitude38.com</a>       | ext. 107 |
| General Manager   | Colleen Young                                                      | <a href="mailto:colleen@latitude38.com">colleen@latitude38.com</a>   | ext. 102 |
| Production        | Annie Bates-Winship                                                | <a href="mailto:annie@latitude38.com">annie@latitude38.com</a>       | ext. 106 |
| Bookkeeping       | Penny Clayton                                                      | <a href="mailto:penny@latitude38.com">penny@latitude38.com</a>       | ext. 101 |
| Other email       | <a href="mailto:general@latitude38.com">general@latitude38.com</a> | Web site: <a href="http://www.latitude38.com">www.latitude38.com</a> |          |

### Latitude 38 Media, LLC

15 Locust Avenue, Mill Valley, CA 94941  
(415) 383-8200 • Fax: (415) 383-5816

[www.latitude38.com](http://www.latitude38.com)

Please address all correspondence by person or department name.



# DECEMBER 2017

● indicates full moon.

→ indicates 2-day races. YRA events indicated in bold type.

| S  | M         | T  | W  | Th | F  | S  |
|----|-----------|----|----|----|----|----|
|    |           |    |    |    | 1  | 2  |
| 3  | 4         | 5  | 6  | 7  | 8  | 9  |
| 10 | 11        | 12 | 13 | 14 | 15 | 16 |
| 17 | <b>18</b> | 19 | 20 | 21 | 22 | 23 |
| 24 | 25        | 26 | 27 | 28 | 29 | 30 |
| 31 |           |    |    |    |    |    |

| WEEKDAY & SPECIAL EVENTS                                                                                                                                                                                                                                                                                                                                                                                                                                                                                                                                                                                                                                                                                       | SATURDAY                                                                                                                                                                                                                                                 | SUNDAY                                                                                                                                                                      |                                             |
|----------------------------------------------------------------------------------------------------------------------------------------------------------------------------------------------------------------------------------------------------------------------------------------------------------------------------------------------------------------------------------------------------------------------------------------------------------------------------------------------------------------------------------------------------------------------------------------------------------------------------------------------------------------------------------------------------------------|----------------------------------------------------------------------------------------------------------------------------------------------------------------------------------------------------------------------------------------------------------|-----------------------------------------------------------------------------------------------------------------------------------------------------------------------------|---------------------------------------------|
| <p><b>December:</b></p> <ul style="list-style-type: none"> <li>Happy Holidays! Check the Calendar in the Nov. or Dec. issue of <i>Latitude 38</i> for lighted boat parades near you.</li> </ul> <p><b>December 2:</b></p> <ul style="list-style-type: none"> <li>Lighted Boat Parade, SCYC – Santa Cruz</li> </ul> <p><b>December 13:</b></p> <ul style="list-style-type: none"> <li>Hanukkah begins at sundown</li> </ul> <p><b>December 21:</b></p> <ul style="list-style-type: none"> <li>Winter Solstice</li> </ul> <p><b>December 25:</b></p> <ul style="list-style-type: none"> <li>Christmas Day</li> </ul> <p><b>December 31:</b></p> <ul style="list-style-type: none"> <li>New Year's Eve</li> </ul> | <p>Winter #2, SeqYC – SB<br/>Seaweed Soup Midwinter #2, GGYC – City<br/>Frost Bite Series #1, BenYC – Carquinez<br/>Perry Cup #2, MPYC – Monterey Bay<br/>Opti/EI Toro Green Midwinters #1, RYC – Potrero</p> <p style="text-align: right;"><b>2</b></p> | <p>Chowder #9, BYC – OC<br/>Small Boat Midwinters #1, RYC – SH<br/>Midwinter #2, SYC – Knox<br/>Fall Race #4, SSC – Stockton</p> <p style="text-align: right;"><b>3</b></p> |                                             |
|                                                                                                                                                                                                                                                                                                                                                                                                                                                                                                                                                                                                                                                                                                                | <p>Midwinters #3, BYC – OC<br/>RegattaPRO Winter One Design Invitational #2, SYC – OC/SH<br/>Santana 22 Team Racing, SCYC – Santa Cruz<br/>Redwood Cup #2, SeqYC – SB</p> <p style="text-align: right;"><b>9</b></p>                                     | <p>Midwinters #4, BYC – OC<br/>Midwinter #2, IYC – Estuary<br/>Spring Lake Winter Series, Santa Rosa SC</p> <p style="text-align: right;"><b>10</b></p>                     |                                             |
|                                                                                                                                                                                                                                                                                                                                                                                                                                                                                                                                                                                                                              | <p>Tiny Robbins Midwinter Series #2, VYC – NB<br/>Midwinter #2, SCYC – Santa Cruz<br/>Island Fever #2, SBYC – SB/SF</p> <p style="text-align: right;"><b>16</b></p>                                                                                      | <p>Chowder #10, BYC – OC</p> <p style="text-align: right;"><b>17</b></p>                                                                                                    |                                             |
|                                                                                                                                                                                                                                                                                                                                                                                                                                                                                                                                                                                                                                                                                                                |                                                                                                                                                                                                                                                          | <p>Chowder #11, BYC – OC</p> <p style="text-align: right;"><b>23</b></p>                                                                                                    | <p style="text-align: right;"><b>24</b></p> |
|                                                                                                                                                                                                                                                                                                                                                                                                                                                                                                                                                                                                                                                                                                                |                                                                                                                                                                                                                                                          | <p>Chowder #12, BYC – OC</p> <p style="text-align: right;"><b>30</b></p>                                                                                                    | <p style="text-align: right;"><b>31</b></p> |

GRAND MARINA

## FULL SERVICE MARINE CENTER



510.865.1200

2099 Grand Street  
Alameda, CA 94501

[grandmarina.com](http://grandmarina.com)



## Marchal Sailmakers

Specializing in  
Sail Repair and Used Sails



After hours pick up and drop off available

2021 ALASKA PACKER PLACE, ALAMEDA, CA 94501

Dominic Marchal • (510) 239-5050

[www.marchalsailmakers.com](http://www.marchalsailmakers.com)

# SAN FRANCISCO BAY

These current charts show direction and speed of the tidal current for each hour of current at the San Francisco Bay entrance. The charts depict the flow of tidal currents under normal weather conditions. Strong winds and freshets, however, bring about non-tidal currents which may modify considerably the speeds and directions shown in the charts.

## USE OF CHARTS

The chart to be used for any specific time is determined by obtaining the difference between the desired time and the time of the nearest Maximum Flood or Maximum Ebb for the Golden Gate. The chart with the title that agrees most nearly with this difference is the one to be used.

The numbers before or after the arrows indicate the 'tropic speed' of the current in knots. To determine the actual speed of the current for a particular day and hour, this tropic speed is multiplied by the factor given in the table to the right, 'Factors for Correcting Speeds'. To find the correct 'predicted speed' as listed in the table, see 'Weekend Currents' on pages 80 and 81.

*The charts on this page and those that follow are from the National Ocean Service, National Oceanic and Atmospheric Administration of the U.S. Department of Commerce.*

## FACTORS FOR CORRECTING SPEEDS

| MAXIMUM FLOOD           |             |     | MAXIMUM EBB             |             |     |
|-------------------------|-------------|-----|-------------------------|-------------|-----|
| Predicted speed (knots) | Factor      |     | Predicted Speed (knots) | Factor      |     |
| 0.5-0.8,                | multiply by | 0.2 | 0.7-1.1,                | multiply by | 0.2 |
| 0.9-1.1,                | multiply by | 0.3 | 1.2-1.5,                | multiply by | 0.3 |
| 1.2-1.4,                | multiply by | 0.4 | 1.6-2.0,                | multiply by | 0.4 |
| 1.5-1.8,                | multiply by | 0.5 | 2.1-2.4,                | multiply by | 0.5 |
| 1.9-2.1,                | multiply by | 0.6 | 2.5-2.9,                | multiply by | 0.6 |
| 2.2-2.4,                | multiply by | 0.7 | 3.0-3.3,                | multiply by | 0.7 |
| 2.5-2.8,                | multiply by | 0.8 | 3.4-3.8,                | multiply by | 0.8 |
| 2.9-3.1,                | multiply by | 0.9 | 3.9-4.2,                | multiply by | 0.9 |
| 3.2-3.4,                | multiply by | 1.0 | 4.3-4.7,                | multiply by | 1.0 |
| 3.5-3.7,                | multiply by | 1.1 | 4.8-5.1,                | multiply by | 1.1 |
| 3.8-4.1,                | multiply by | 1.2 | 5.2-5.6,                | multiply by | 1.2 |
| 4.2-4.4,                | multiply by | 1.3 | 5.7-6.0,                | multiply by | 1.3 |
| 4.5-4.7,                | multiply by | 1.4 | 6.1-6.5,                | multiply by | 1.4 |
| 4.8-5.1,                | multiply by | 1.5 | 6.6-6.9,                | multiply by | 1.5 |

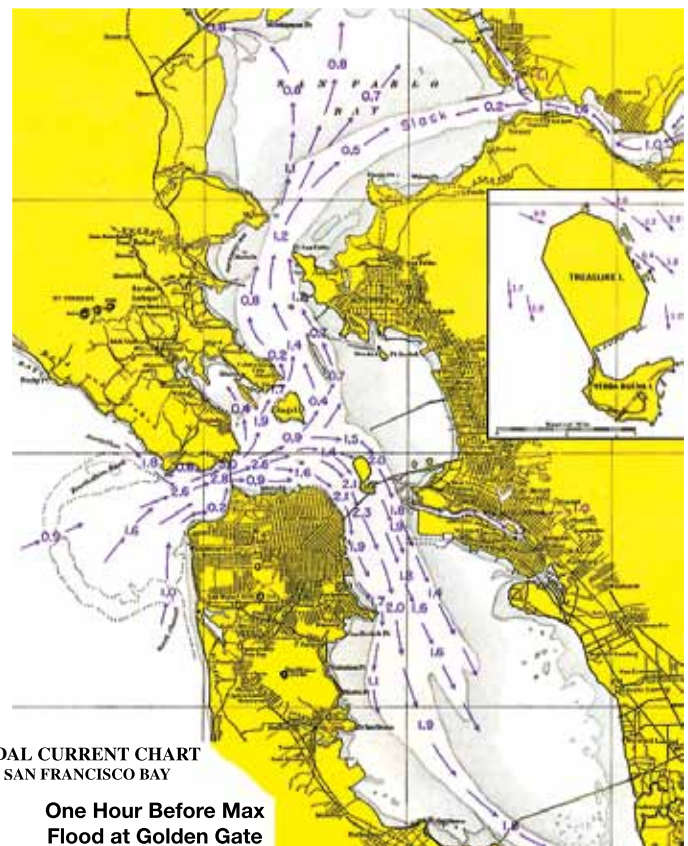
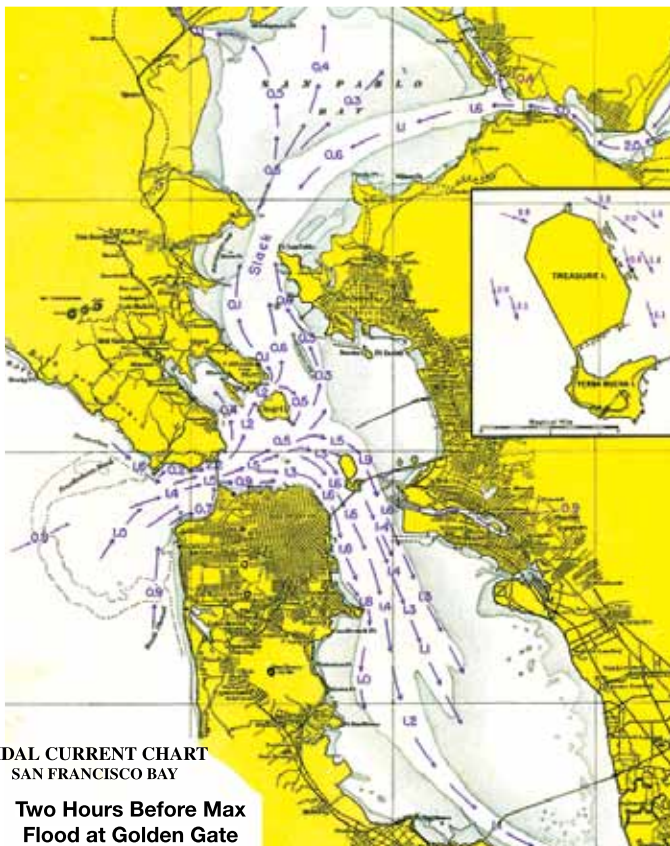

# TIDAL CURRENT CHARTS

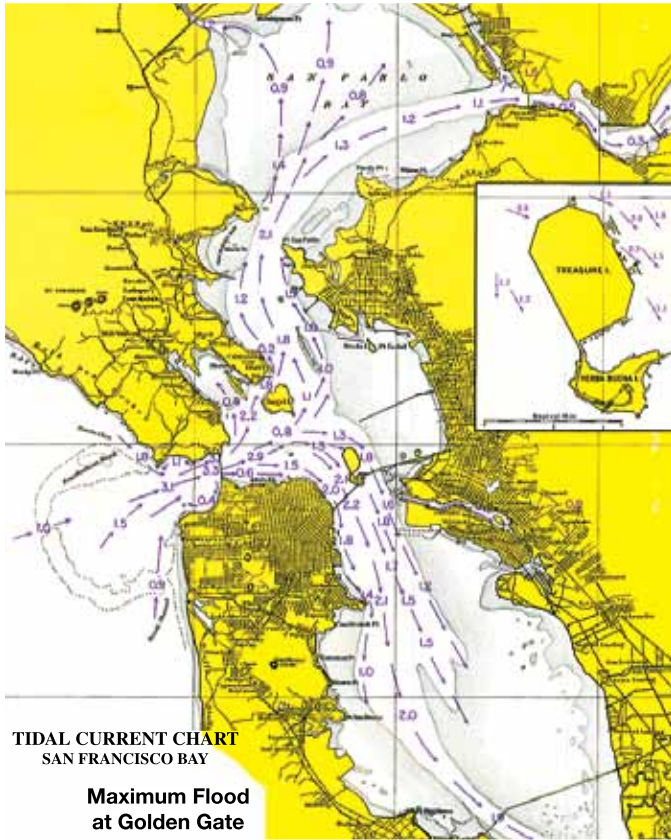

TIDAL CURRENT CHART  
SAN FRANCISCO BAY

Maximum Flood  
at Golden Gate

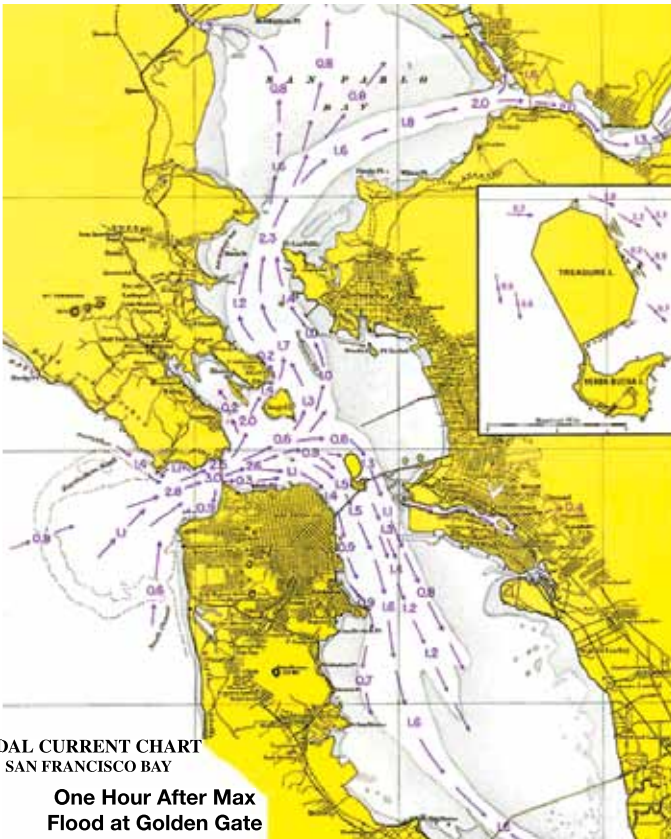

TIDAL CURRENT CHART  
SAN FRANCISCO BAY

One Hour After Max  
Flood at Golden Gate

From the detailed assembly, finishing and unconventional thinking, Tylaska products provide sailors the ultimate in performance, strength & sailing pleasure.

# Tylaska

DIVISION OF VECTOR ENGINEERING, INC.  
MYSTIC, CT • MADE IN THE USA • (860) 572-8440

[www.tylaska.com](http://www.tylaska.com)

# SAN FRANCISCO BAY

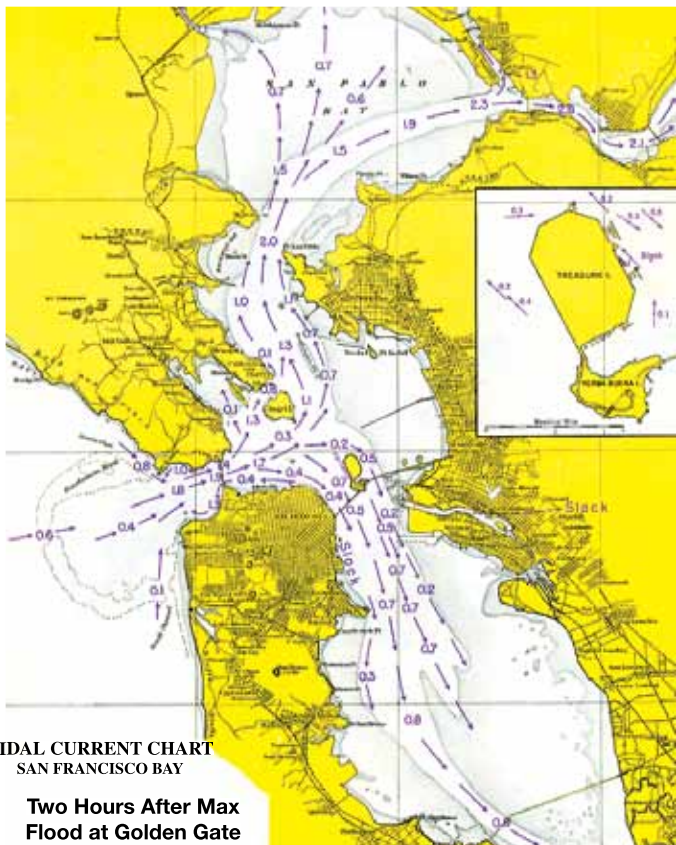

TIDAL CURRENT CHART  
SAN FRANCISCO BAY

Two Hours After Max  
Flood at Golden Gate

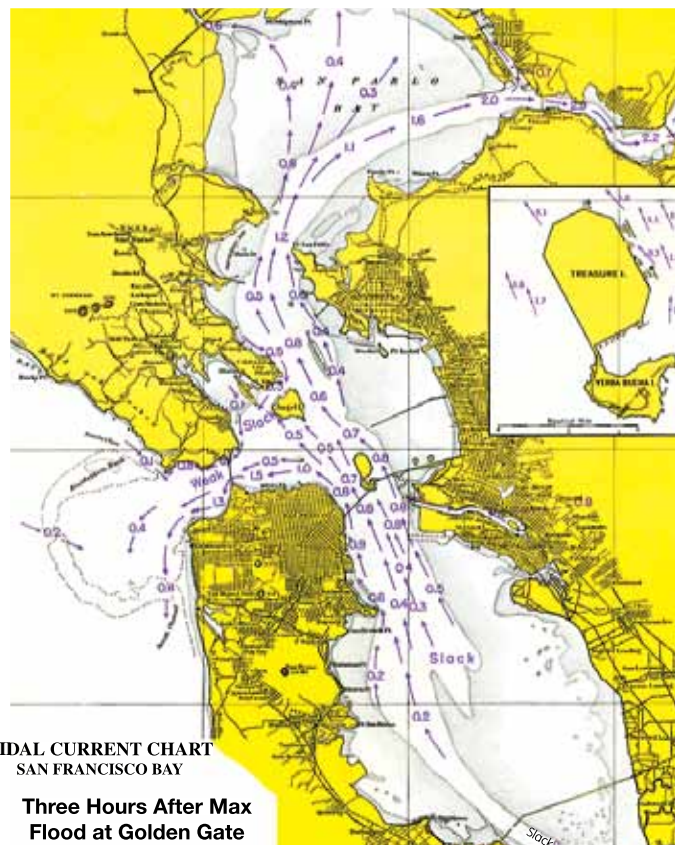

TIDAL CURRENT CHART  
SAN FRANCISCO BAY

Three Hours After Max  
Flood at Golden Gate

**FILL YOUR COCKPIT  
WITH CREW**

Go to *Latitude 38's*  
**FREE** online crew list at  
[www.latitude38.com](http://www.latitude38.com)  
and join us at our  
**CREW LIST PARTIES**  
Check our website and  
*'Lectronic Latitude for info.*

*Pacific* INTER CLUB *Yacht Association*

~ ANNOUNCEMENT OF 2017 REGATTAS ~

**CHISPA**  
*Hosted by Encinal Yacht Club • June 17*  
Laser PICYA Small Boat Perpetual Trophy All ages  
*One boat per yacht club*

**LIPTON CUP SERIES**  
*Hosted by Sausalito Yacht Club • Saturday, July 8*  
Big Lipton J/105 Class  
Larry Knight Perpetual Challenge Express 27 Class  
Little Lipton SF 30 Class  
Admiral's Perpetual Trophy Cal 20 Class

**YOUTH REGATTA**  
*Hosted by Sequoia YC and BAYS • July 29-30*

|          |            |             |
|----------|------------|-------------|
| Optimist | Division A | 10 & under  |
| Optimist | Division B | 12 & under  |
| El Toro  | Division C | 16 & under  |
| CFJ      | Division D | Grades 8-12 |

*Two boats per division per yacht club.*

Go to [www.picya.org](http://www.picya.org) for Regatta News

# TIDAL CURRENT CHARTS

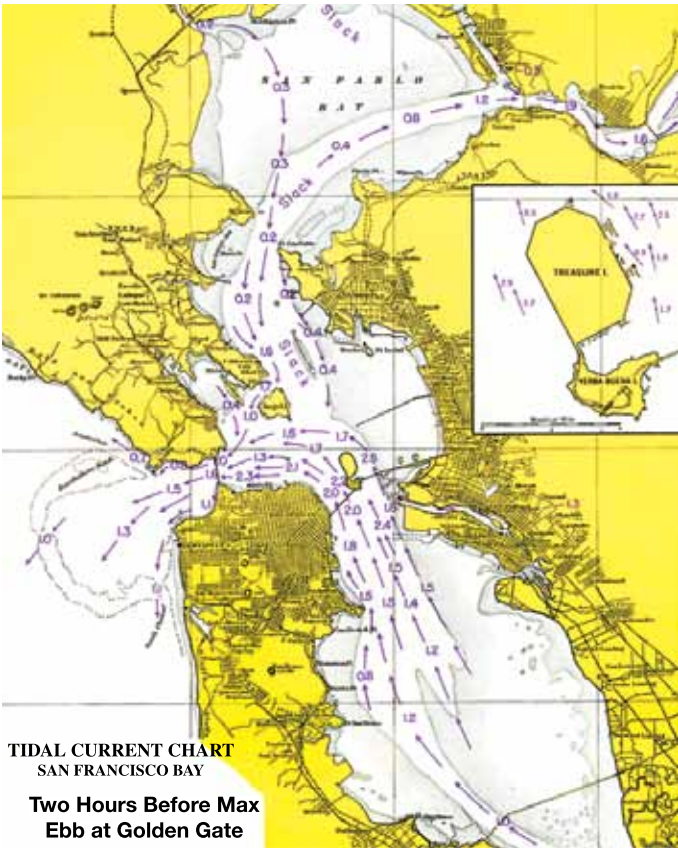

TIDAL CURRENT CHART  
SAN FRANCISCO BAY  
Two Hours Before Max  
Ebb at Golden Gate

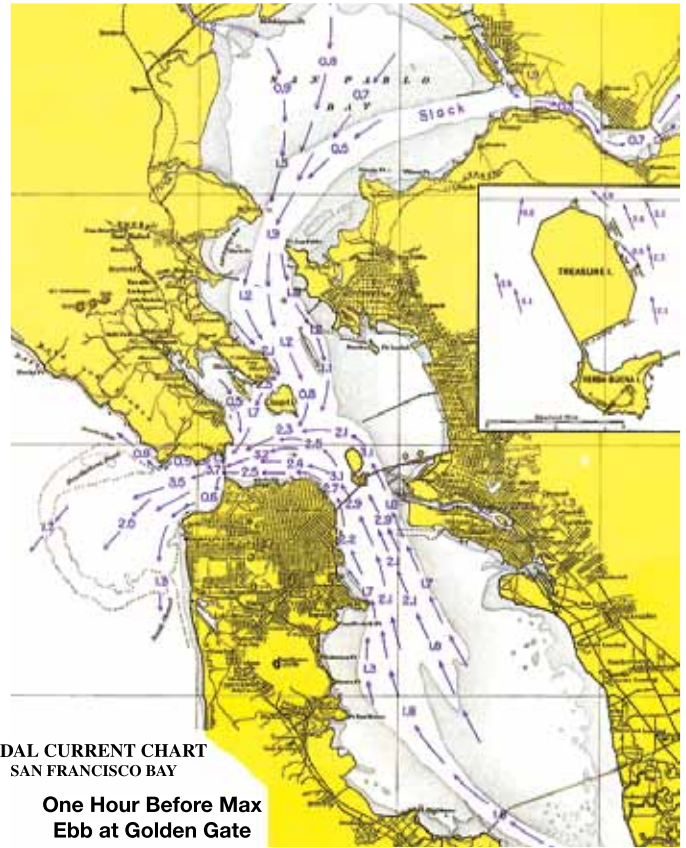

TIDAL CURRENT CHART  
SAN FRANCISCO BAY  
One Hour Before Max  
Ebb at Golden Gate

 **ALPHAROPES**<sup>®</sup> [www.alpha-ropes.com](http://www.alpha-ropes.com)



# SAN FRANCISCO BAY

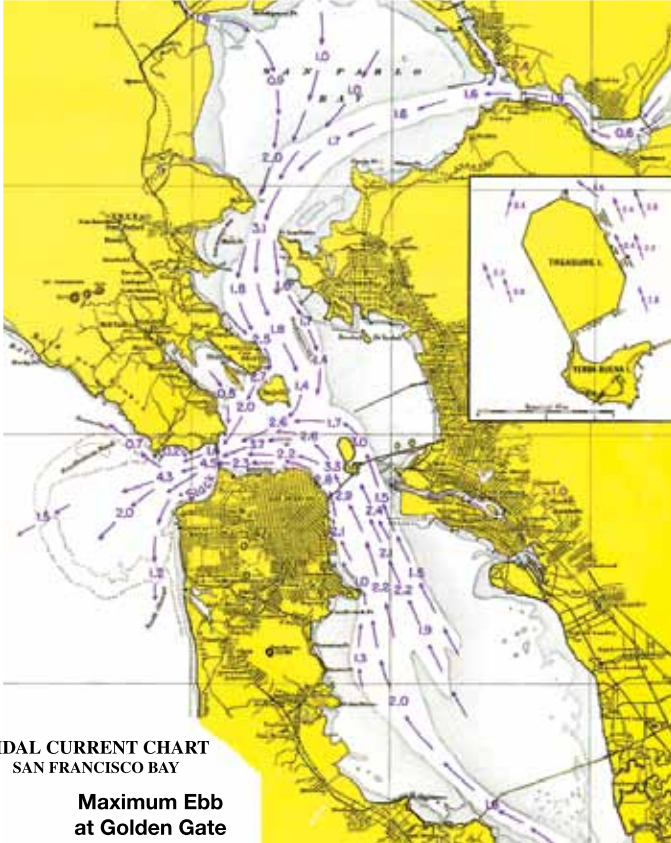

TIDAL CURRENT CHART  
SAN FRANCISCO BAY

Maximum Ebb  
at Golden Gate

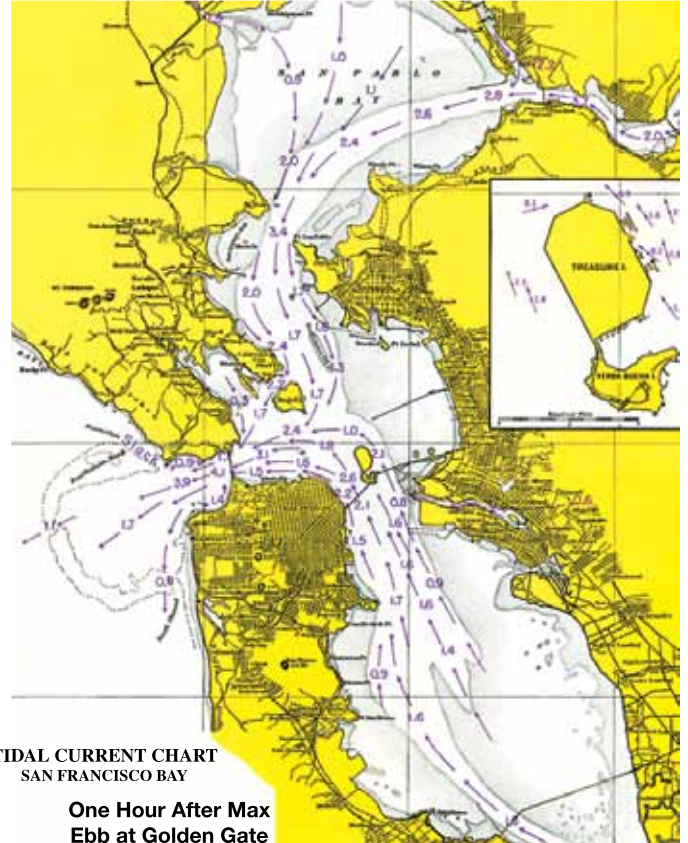

TIDAL CURRENT CHART  
SAN FRANCISCO BAY

One Hour After Max  
Ebb at Golden Gate

## **Davis**

### SNAP TOOL • MULTI-KEY *Many Tools in One*

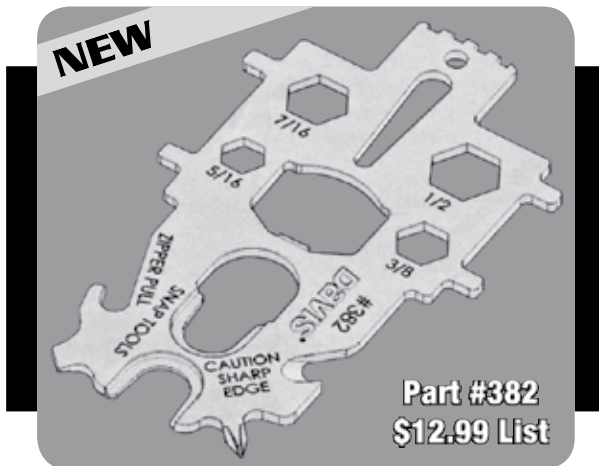

Part #382  
\$12.99 List

Handy • Universal • Stainless Steel  
Strong • Compact • Easy to store and use

**Davis Instruments** 3465 Diablo Ave., Hayward, CA 94545 USA  
Phone 800-678-3669 • Fax 510-670-0589 • Email info@davisnet.com

[www.davisnet.com](http://www.davisnet.com)

## FAST, LIGHT, EFFICIENT

*Outboard Motor Shop has the power you need to get to or from the race course!*

### HONDA MARINE



- 2 to 250 horsepower
- As low as 29.5 lbs engine weight!
- 5-year warranty

© 2017 American Honda Motor Co., Inc.  
Always wear a personal flotation device while boating and read your owner's manual. 5-year warranty standard on all new Honda outboard engines purchased. Check with participating dealers for complete details.

**Outboard Motor Shop**  
*Where the professionals shop!*

(510) 533-9290

[www.outboardmotorshop.com](http://www.outboardmotorshop.com)

333 Kennedy St., Oakland, CA 94606 • Fax 510-533-3374

# TIDAL CURRENT CHARTS

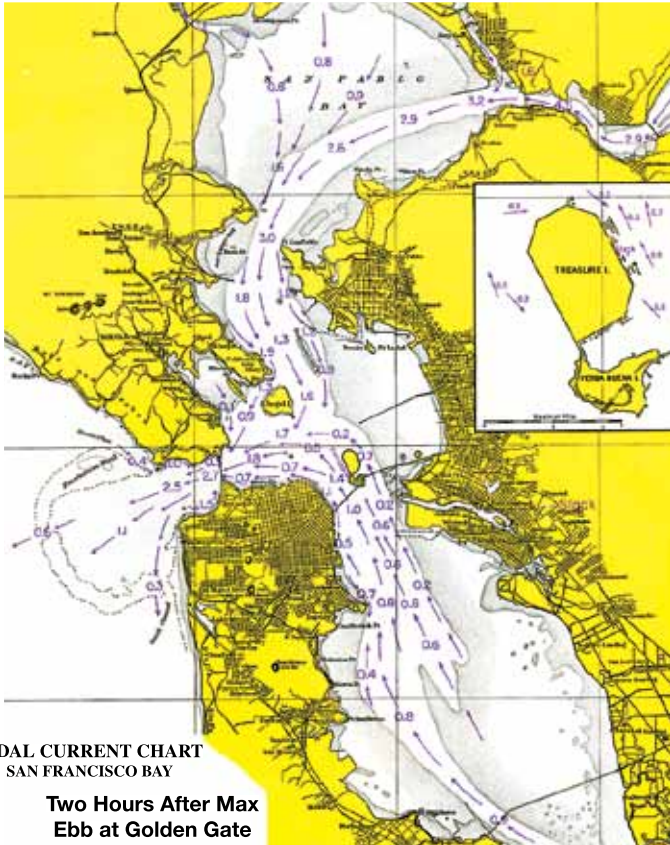

TIDAL CURRENT CHART  
SAN FRANCISCO BAY  
Two Hours After Max  
Ebb at Golden Gate

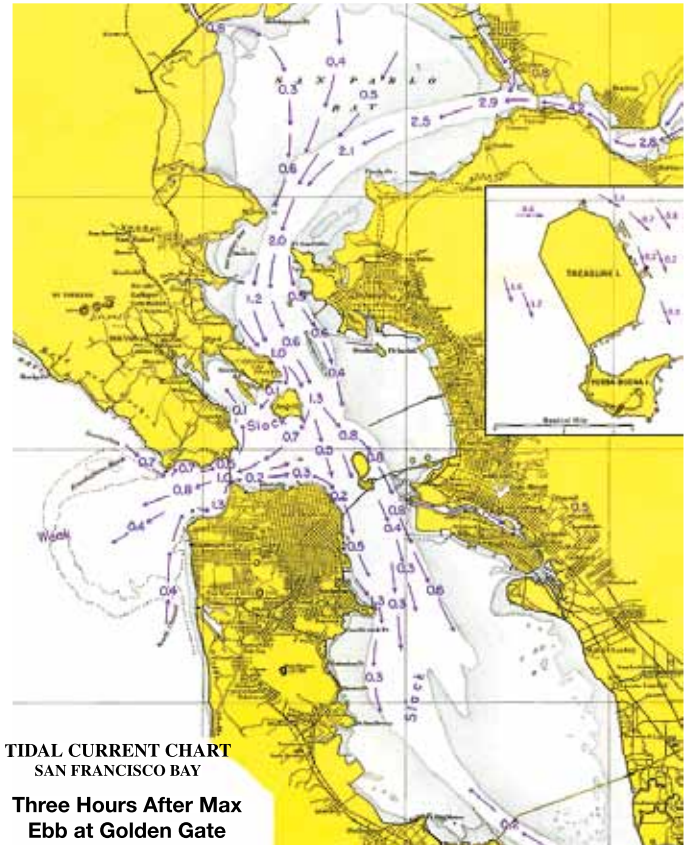

TIDAL CURRENT CHART  
SAN FRANCISCO BAY  
Three Hours After Max  
Ebb at Golden Gate

COMBINING A LOVE FOR WINE *with*  
A PASSION *for* SAILING.



*Dry Creek*  
VINEYARD

THE OFFICIAL  
SINCE 1972

WINE FOR  
SAILORS™

“The good folks at Dry Creek are committed to our sport and to making great wine.”

— Peter Isler, two-time America’s Cup winner



# 2017 WEEKEND CURRENTS

JANUARY – JUNE

| J<br>A<br>N<br>U<br>A<br>R<br>Y | date/day | slack     | max       | slack | max       | F<br>E<br>B<br>R<br>U<br>A<br>R<br>Y | date/day | slack     | max       | slack     | max       | M<br>A<br>R<br>C<br>H | date/day  | slack     | max       | slack     | max       |           |
|---------------------------------|----------|-----------|-----------|-------|-----------|--------------------------------------|----------|-----------|-----------|-----------|-----------|-----------------------|-----------|-----------|-----------|-----------|-----------|-----------|
|                                 | 1/01Sun  | 0330      | 0548/1.1E | 0812  | 1148/2.6F |                                      |          | 2/04Sat   |           | 0324/3.0F | 0618      |                       | 0912/2.0E |           | 3/04Sat   |           | 0200/3.0F | 0436      |
|                                 | 1412     | 1706/2.4E | 2118      |       |           |                                      | 1306     | 1618/2.3F | 1930      | 2212/1.1E |           |                       | 1118      | 1448/2.7F | 1806      | 2042/1.1E |           |           |
|                                 |          |           |           |       |           |                                      |          |           |           |           |           |                       | 2318      |           |           |           |           |           |
|                                 | 1/07Sat  | 0106      | 0454/3.2F | 0800  | 1100/2.2E |                                      | 2/05Sun  | 0042      | 0424/2.9F | 0718      | 1012/2.1E |                       | 3/05Sun   |           | 0254/2.7F | 0536      | 0818/2.1E |           |
|                                 |          | 1500      | 1748/2.3F | 2100  | 2336/1.2E |                                      |          | 1424      | 1724/2.5F | 2048      | 2318/1.1E |                       |           | 1230      | 1554/2.6F | 1924      | 2200/1.0E |           |
|                                 | 1/8Sun   | 0200      | 0554/3.3F | 0848  | 1154/2.5E |                                      | 2/11Sat  | 0106      | 0400/1.7E | 0712      | 1000/3.4F |                       | 3/11Sat   |           | 0248/2.0E | 0618      | 0900/3.3F |           |
|                                 |          | 1606      | 1848/2.7F | 2206  |           |                                      |          | 1254      | 1612/2.4E | 1954      | 2242/3.7F |                       |           | 1200      | 1506/2.0E | 1842      | 2130/3.7F |           |
|                                 | 1/14Sat  | 0224      | 0506/1.5E | 0806  | 1100/3.3F |                                      | 2/12Sun  | 0154      | 0448/1.8E | 0800      | 1048/3.3F |                       | 3/12Sun   | 0036      | 0436/2.1E | 0806      | 1048/3.4F |           |
|                                 |          | 1348      | 1700/2.6E | 2100  | 2348/3.7F |                                      |          | 1348      | 1700/2.3E | 2036      | 2324/3.7F |                       |           | 1354      | 1654/2.0E | 2024      | 2312/3.7F |           |
|                                 | 1/15Sun  | 0312      | 0600/1.5E | 0900  | 1154/3.0F |                                      | 2/18Sat  |           | 0300/2.1F | 0612      | 0912/1.2E |                       | 3/18Sat   |           | 0230/2.2F | 0512      | 0754/1.5E |           |
|                                 |          | 1442      | 1754/2.3E | 2136  |           |                                      |          | 1330      | 1618/1.6F | 1954      | 2200/0.8E |                       |           | 1206      | 1542/2.0F | 1924      | 2142/0.8E |           |
|                                 | 1/21Sat  | 0054      | 0436/2.4F | 0812  | 1112/1.4E |                                      | 2/19Sun  | 0006      | 0348/1.9F | 0700      | 1000/1.1E |                       | 3/19Sun   |           | 0318/1.8F | 0554      | 0836/1.3E |           |
|                                 |          | 1530      | 1812/1.7F | 2124  | 2324/0.9E |                                      |          | 1430      | 1730/1.7F | 2100      | 2300/0.8E |                       |           | 1242      | 1636/1.9F | 2036      | 2236/0.7E |           |
|                                 | 1/22Sun  | 0136      | 0530/2.3F | 0848  | 1154/1.5E |                                      | 2/20Mon  | 0100      | 0448/1.7F | 0754      | 1100/1.1E |                       | 3/25Sat   | 0000      | 0236/1.6E | 0536      | 0848/2.4F |           |
|                                 |          | 1618      | 1906/2.0F | 2218  |           |                                      |          | 1524      | 1824/1.9F | 2154      | 2354/0.9E |                       |           | 1142      | 1436/1.7E | 1812      | 2124/3.1F |           |
|                                 | 1/28Sat  | 0130      | 0400/1.2E | 0624  | 1000/2.9F |                                      | 2/25Sat  | 0012      | 0242/1.5E | 0530      | 0854/2.8F |                       | 3/26Sun   | 0030      | 0312/1.9E | 0624      | 0936/2.8F |           |
|                                 |          | 1236      | 1536/2.3E | 1948  | 2254/3.2F |                                      |          | 1142      | 1442/2.0E | 1836      | 2142/3.2F |                       |           | 1230      | 1518/1.8E | 1848      | 2206/3.4F |           |
|                                 | 1/29Sun  | 0206      | 0436/1.4E | 0712  | 1042/3.0F |                                      | 2/26Sun  | 0048      | 0324/1.7E | 0618      | 0942/3.0F |                       |           |           |           |           |           |           |
|                                 |          | 1324      | 1618/2.4E | 2018  | 2330/3.3F |                                      |          | 1230      | 1530/2.1E | 1912      | 2218/3.4F |                       |           |           |           |           |           |           |
| A<br>P<br>R<br>I<br>L           | date/day | slack     | max       | slack | max       | M<br>A<br>Y                          | date/day | slack     | max       | slack     | max       | J<br>U<br>N<br>E      | date/day  | slack     | max       | slack     | max       |           |
|                                 | 4/01Sat  |           | 0142/3.2F | 0412  | 0654/2.9E |                                      | 5/06Sat  |           | 0136/2.0E | 0518      | 0748/2.4F |                       |           | 6/03Sat   |           | 0018/1.6E | 0400      | 0624/1.9F |
|                                 |          | 1106      | 1430/3.3F | 1748  | 2024/1.2E |                                      |          | 1054      | 1336/1.5E | 1648      | 2000/3.4F |                       |           | 0924      | 1212/1.3E | 1512      | 1836/3.2F |           |
|                                 |          | 2300      |           |       |           |                                      |          | 2318      |           |           |           |                       | 2206      |           |           |           |           |           |
|                                 | 4/02Sun  |           | 0230/2.8F | 0500  | 0742/2.6E |                                      | 5/07Sun  |           | 0218/2.2E | 0612      | 0842/2.7F |                       | 6/04Sun   |           | 0112/1.9E | 0506      | 0730/2.1F |           |
|                                 |          | 1200      | 1530/3.1F | 1900  | 2136/1.0E |                                      |          | 1154      | 1424/1.4E | 1736      | 2042/3.5F |                       |           | 1036      | 1306/1.3E | 1600      | 1924/3.2F |           |
|                                 | 4/08Sat  |           | 0236/2.1E | 0624  | 0900/2.9F |                                      | 5/13Sat  |           | 0000/2.6F | 0236      | 0530/2.3E |                       | 6/10Sat   | 0130      | 0430/2.3E | 0912      | 1200/3.0F |           |
|                                 |          | 1200      | 1448/1.7E | 1818  | 2118/3.6F |                                      |          | 1000      | 1306/2.9F | 1654      | 1900/0.9E |                       |           | 1542      | 1748/0.9E | 1954      | 2330/2.5F |           |
|                                 | 4/09Sun  | 0024      | 0324/2.3E | 0712  | 0948/3.1F |                                      | 5/14Sun  | 1024      | 1348/2.7F | 1742      | 1948/0.8E |                       | 6/11Sun   | 0200      | 0500/2.3E | 0936      | 1236/2.9F |           |
|                                 |          | 1254      | 1542/1.7E | 1900  | 2200/3.6F |                                      |          | 2142      |           |           |           |                       | 1624      | 1830/0.9E | 2036      |           |           |           |
|                                 | 4/15Sat  |           | 0112/2.4F | 0348  | 0630/2.0E |                                      | 5/20Sat  |           | 0012/1.3E | 0306      | 0606/1.5F |                       | 6/17Sat   | 0112      | 0424/1.6F | 0654      | 1006/1.4E |           |
|                                 |          | 1054      | 1418/2.5F | 1806  | 2018/0.8E |                                      |          | 0848      | 1200/1.3E | 1448      | 1842/3.0F |                       |           | 1318      | 1706/2.9F | 2036      | 2330/1.5E |           |
|                                 |          | 2218      |           |       |           |                                      | 5/21Sun  | 1000      | 1254/1.4E | 1536      | 1930/3.2F |                       | 6/18Sun   | 0236      | 0536/1.7F | 0818      | 1124/1.3E |           |
|                                 | 4/16Sun  |           | 0148/2.0F | 0418  | 0700/1.8E |                                      |          | 2242      |           |           |           |                       | 1406      | 1800/3.1F | 2118      |           |           |           |
|                                 |          | 1112      | 1506/2.3F | 1906  | 2112/0.7E |                                      | 5/27Sat  | 0154      | 0442/3.3E | 0918      | 1218/3.8F |                       | 6/24Sat   | 0048      | 0342/3.1E | 0818      | 1112/3.7F |           |
|                                 |          | 2300      |           |       |           |                                      |          | 1542      | 1806/1.2E | 2036      |           |                       | 1430      | 1700/1.2E | 1936      | 2300/3.6F |           |           |
|                                 | 4/22Sat  |           | 0130/1.6E | 0436  | 0730/1.9F |                                      | 5/28Sun  | 1000      | 1306/3.8F | 1636      | 1900/1.2E |                       | 6/25Sun   | 0136      | 0436/3.1E | 0906      | 1200/3.8F |           |
|                                 |          | 1024      | 1324/1.4E | 1630  | 2006/3.0F |                                      |          | 2136      |           |           |           |                       | 1524      | 1754/1.3E | 2030      | 2354/3.4F |           |           |
|                                 | 4/23Sun  |           | 0206/2.0E | 0530  | 0824/2.4F |                                      | 5/29Mon  | 1042      | 1354/3.7F | 1730      | 2006/1.1E |                       |           |           |           |           |           |           |
|                                 |          | 1124      | 1412/1.6E | 1712  | 2048/3.3F |                                      |          | 2236      |           |           |           |                       |           |           |           |           |           |           |
|                                 | 4/29Sat  |           | 0030/3.5F | 0300  | 0548/3.3E |                                      |          |           |           |           |           |                       |           |           |           |           |           |           |
|                                 |          | 1006      | 1318/3.7F | 1648  | 1906/1.2E |                                      |          |           |           |           |           |                       |           |           |           |           |           |           |
|                                 |          | 2148      |           |       |           |                                      |          |           |           |           |           |                       |           |           |           |           |           |           |
|                                 | 4/30Sun  |           | 0118/3.1F | 0342  | 0630/3.0E |                                      |          |           |           |           |           |                       |           |           |           |           |           |           |
|                                 |          | 1054      | 1412/3.5F | 1748  | 2018/1.1E |                                      |          |           |           |           |           |                       |           |           |           |           |           |           |
|                                 |          | 2242      |           |       |           |                                      |          |           |           |           |           |                       |           |           |           |           |           |           |

Serving the Bay Area Since 1986



**THE FASTEST POLISH ON THE BAY!**

Be Race Ready Friday With Our Mid-Week Clean & Prep

Fully Insured & Marina Approved  
Call now for a Free Estimate

**510 428-2522 or 415 457-6300**  
**www.seashine.net**



**Express 27**  
THE ULTIMATE SAILING MACHINE

[www.express27.org](http://www.express27.org)

Fleet Captain:  
Zachery Anderson  
zachery.anderson@gmail.com

[www.facebook.com/express27fleet](http://www.facebook.com/express27fleet)



|  | JULY     |       |           |       |           |  | AUGUST   |       |           |       |           |  | SEPTEMBER |       |           |           |           |           | OCTOBER  |       |           |           |           |           | NOVEMBER |       |           |           |           |           | DECEMBER |           |           |           |           |           |  |
|--|----------|-------|-----------|-------|-----------|--|----------|-------|-----------|-------|-----------|--|-----------|-------|-----------|-----------|-----------|-----------|----------|-------|-----------|-----------|-----------|-----------|----------|-------|-----------|-----------|-----------|-----------|----------|-----------|-----------|-----------|-----------|-----------|--|
|  | date/day | slack | max       | slack | max       |  | date/day | slack | max       | slack | max       |  | date/day  | slack | max       | slack     | max       |           | date/day | slack | max       | slack     | max       |           | date/day | slack | max       | slack     | max       |           | date/day | slack     | max       | slack     | max       |           |  |
|  | 7/01Sat  | 0224  | 0442/1.8F | 0748  | 1042/1.4E |  | 8/05Sat  |       | 0230/1.7E | 0706  | 0948/2.6F |  | 9/02Sat   |       | 0124/1.3E | 0536      | 0836/2.4F |           | 10/01Sun |       | 0054/1.1E | 0424      | 0754/2.4F |           | 11/04Sat | 0142  | 0406/1.4E | 0654      | 1036/3.7F |           | 12/02Sat |           | 0154/1.3E | 0430      | 0824/3.6F |           |  |
|  |          | 1336  | 1700/3.0F | 2042  | 2342/1.5E |  |          | 1312  | 1518/1.1E | 1748  | 2118/2.4F |  |           | 1200  | 1406/1.2E | 1654      | 2012/2.0F |           |          | 1118  | 1342/1.3E | 1642      | 1942/1.8F |           |          | 1312  | 1600/3.1E | 2018      | 2324/3.5F |           |          | 1106      | 1354/3.1E | 1824      | 2118/3.3F |           |  |
|  | 7/02Sun  | 0336  | 0600/1.8F | 0906  | 1136/1.2E |  | 8/06Sun  | 0012  | 0312/1.8E | 0736  | 1024/2.7F |  | 9/03Sun   | 2306  | 0206/1.4E | 0612      | 0912/2.6F |           | 10/07Sat | 0242  | 0518/1.7E | 0818      | 1148/3.6F |           | 11/05Sun | 0136  | 0400/1.4E | 0642      | 1018/3.6F |           | 12/03Sun | 1230      | 0242/1.2E | 0524      | 0906/3.6F |           |  |
|  |          | 1424  | 1800/2.9F | 2130  |           |  |          | 1342  | 1600/1.2E | 1830  | 2200/2.5F |  |           | 1230  | 1448/1.3E | 1742      | 2054/2.2F |           |          | 1424  | 1712/2.9E | 2106      |           |           |          | 1148  | 1436/3.2E | 1906      | 2206/3.6F |           |          | 1148      | 1436/3.2E | 1906      | 2206/3.6F |           |  |
|  | 7/08Sat  | 0030  | 0330/2.0E | 0812  | 1100/2.8F |  | 8/12Sat  |       | 0142/2.7F | 0430  | 0712/1.9E |  | 9/04Mon   | 2354  | 0248/1.6E | 0648      | 0948/2.8F |           | 10/08Sun | 1424  | 0024/3.5F | 0330      | 0600/1.6E |           | 11/11Sat | 0012  | 0336/3.2F | 0724      | 1006/1.3E |           | 12/09Sat | 1130      | 0212/3.4F | 0548      | 0836/1.2E |           |  |
|  |          | 1424  | 1630/0.9E | 1848  | 2224/2.6F |  |          | 1042  | 1418/3.2F | 1706  | 1942/1.9E |  |           | 1300  | 1530/1.5E | 1824      | 2142/2.5F |           |          | 0900  | 1230/3.5F | 1500      | 1748/3.1E |           |          | 1312  | 1548/2.0F | 1830      | 2142/1.6E |           |          | 1300      | 0312/3.3F | 0648      | 0942/1.4E |           |  |
|  | 7/09Sun  | 0106  | 0406/2.1E | 0842  | 1136/2.9F |  | 8/13Sun  | 2306  | 0242/2.5F | 0524  | 0812/1.6E |  | 9/09Sat   | 0936  | 0042/3.2F | 0336      | 0618/1.9E |           | 10/09Mon | 2154  | 0112/3.5F | 0424      | 0648/1.4E |           | 11/12Sun | 0118  | 0436/3.2F | 0818      | 1112/1.6E |           | 12/10Sun | 2348      | 1424/2.2F | 1700      | 2006/1.9E |           |  |
|  |          | 1506  | 1718/1.0E | 1930  | 2306/2.6F |  |          | 1124  | 1500/3.1F | 1754  | 2030/2.0E |  |           | 2206  | 1300/3.4F | 1542      | 1818/2.5E |           |          | 0942  | 1312/3.2F | 1542      | 1830/3.0E |           |          | 1442  | 1706/2.0F | 2000      | 2300/1.5E |           |          | 1112      | 1530/2.0F | 1818      | 2124/1.6E |           |  |
|  | 7/15Sat  |       | 0300/2.1F | 0530  | 0830/1.7E |  | 8/19Sat  |       | 0142/2.3E | 0600  | 0848/3.3F |  | 9/10Sun   | 1012  | 0130/3.1F | 0424      | 0700/1.7E |           | 10/14Sat | 0942  | 0112/3.5F | 0424      | 0648/1.4E |           | 11/18Sat | 0112  | 0324/1.2E | 0606      | 0924/3.3F |           | 12/16Sat | 0006      | 0206/1.1E | 0442      | 0818/3.1F |           |  |
|  |          | 1200  | 1542/3.0F | 1848  | 2136/1.5E |  |          | 1206  | 1442/1.5E | 1742  | 2054/3.2F |  |           | 2254  | 1342/3.3F | 1618      | 1900/2.6E |           |          | 2236  | 1312/3.2F | 1542      | 1830/3.0E |           |          | 1218  | 1530/2.5E | 1954      | 2236/3.2F |           |          | 1112      | 1424/2.3E | 1854      | 2130/3.0F |           |  |
|  | 7/16Sun  | 0036  | 0400/1.9F | 0642  | 0942/1.4E |  | 8/20Sun  | 2342  | 0242/2.4E | 0654  | 0942/3.5F |  | 9/16Sat   | 1100  | 0030/1.9E | 0430      | 0736/3.1F |           | 10/15Sun | 2230  | 0018/1.7E | 0354      | 0706/3.2F |           | 11/19Sun | 0200  | 0418/1.1E | 0642      | 1006/3.0F |           | 12/17Sun | 1254      | 0300/1.0E | 0530      | 0900/2.9F |           |  |
|  |          | 1242  | 1630/3.0F | 1936  | 2230/1.7E |  |          | 1254  | 1536/1.7E | 1848  | 2148/3.4F |  |           | 2236  | 1100      | 1336/1.6E | 1648      | 1942/2.7F |          |       | 1036      | 1324/1.8E | 1654      | 1930/2.5F |          |       | 1248      | 1600/2.4E | 2030      | 2312/3.2F |          |           | 1148      | 1500/2.3E | 1930      | 2212/3.1F |  |
|  | 7/22Sat  |       | 0242/2.8E | 0718  | 1000/3.5F |  | 8/26Sat  |       | 0200/2.8F | 0506  | 0800/1.6E |  | 9/17Sun   | 1142  | 0136/2.0E | 0530      | 0830/3.4F |           | 10/21Sat | 2224  | 0542/1.4E | 0824      | 1136/3.3F |           | 11/23Th  | 0918  | 0118/2.7F | 0518      | 0724/0.7E |           | 12/23Sat | 0936      | 0124/2.7F | 0512      | 0730/0.8E |           |  |
|  |          | 1318  | 1548/1.4E | 1836  | 2200/3.5F |  |          | 1054  | 1406/3.0F | 1712  | 2006/1.7E |  |           | 2336  | 1430/1.8E | 1754      | 2042/3.0F |           |          | 1424  | 1818/2.2F | 2112      | 2306/3.2F |           |          | 2212  | 1248/1.7F | 1506      | 1754/1.8E |           |          | 1306/1.8F | 1530      | 1824/1.8E |           |           |  |
|  | 7/23Sun  | 1242  | 0336/2.8E | 0806  | 1048/3.7F |  | 8/27Sun  |       | 0254/2.4F | 0612  | 0854/1.3E |  | 9/23Sat   | 0942  | 0142/2.9F | 0506      | 0736/1.3E |           | 10/22Sun | 2230  | 0036/3.2F | 0406      | 0624/1.2E |           | 11/24Fri | 1006  | 1336/1.4F | 1548      | 1842/1.6E |           | 12/24Sun | 1030      | 0206/2.7F | 0548      | 0818/0.9E |           |  |
|  |          | 1406  | 1642/1.5E | 1936  | 2248/3.5F |  |          | 0000  | 0254/2.4F | 0612  | 0854/1.3E |  |           | 2248  | 1330/2.8F | 1618      | 1906/2.0E |           |          | 0900  | 1218/2.9F | 1500      | 1800/2.3E |           |          | 2248  | 1430/1.3F | 1642      | 1948/1.4E |           |          | 1400/1.6F | 1618      | 1924/1.6E |           |           |  |
|  | 7/29Sat  | 1236  | 0318/2.2F | 0618  | 0912/1.5E |  | 8/27Sun  | 1124  | 1454/2.6F | 1754  | 2054/1.5E |  | 9/24Sun   | 1012  | 0142/2.9F | 0506      | 0736/1.3E |           | 10/28Sat | 1406  | 0524/2.2F | 0936      | 1142/0.9F |           | 11/25Sat | 1106  | 1430/1.3F | 1642      | 1948/1.4E |           | 12/25Mon | 1136      | 0254/2.7F | 0630      | 0912/1.1E |           |  |
|  |          | 1206  | 1530/2.9F | 1854  | 2154/1.4E |  |          |       |           |       |           |  |           | 2324  | 1330/2.8F | 1618      | 1906/2.0E |           |          | 2224  | 1736/2.5E | 2148      | 2306/3.2F |           |          | 2336  | 1500/1.5F | 1724      | 2036/1.4E |           |          | 1500/1.5F | 1724      | 2036/1.4E |           |           |  |
|  | 7/30Sun  | 0148  | 0424/1.9F | 0730  | 1012/1.2E |  |          |       |           |       |           |  | 9/30Sat   | 0336  | 0712/2.2F | 1048      | 1300/1.1E |           | 10/29Sun | 1518  | 0618/2.3F | 1012      | 1230/1.1E |           | 11/26Sun | 1218  | 1530/1.2F | 1754      | 2118/1.2E |           | 12/30Sat | 0954      | 0048/1.2E | 0312      | 0706/3.4F |           |  |
|  |          | 1248  | 1624/2.6F | 1948  | 2254/1.4E |  |          |       |           |       |           |  |           | 1548  | 1848/1.4F | 2142      |           |           |          | 2224  | 1812/1.3F | 2100      |           |           |          |       |           |           |           |           |          |           |           |           |           |           |  |



## Master Mariners 24<sup>th</sup> Wooden Boat Show • Sunday, June 25

10 am to 4 pm ~ Corinthian Yacht Club

View and board classic sailing vessels, meet their skippers and learn the yachts' unique history. Show proceeds to go Master Mariners Benevolent 501(c)3 Foundation. The Foundation provides scholarships for youth sailing, wooden boat building and maritime education. Also provides for the preservation of SF Bay Classic yachts. MMBF is dedicated to preserving the continuity of traditional yachting on San Francisco Bay. Outdoor bar and grill is open for lunch. Model boat building for kids. Children under 12 free when accompanied by an adult.

Our Annual Regatta – Saturday, May 27

Master Mariners Benevolent Association

[www.mastermariners.org](http://www.mastermariners.org)



## Sail / Rig Consultation, Service and New Sails

Since 1988 and serving all points of the California coast with professional, quality work and consultations

Contact us today for your needs and/or to discuss new sails

NorCal: John Amen 707-762-9771  
SoCal: Kern Ferguson 949-903-5376

### Neil Pryde Sails Int.

1681 Barnum Avenue, Stratford CT 06614

203-375-2626 or at  
admin@neilprydesails.com  
www.neilprydesails.com

## SANTA CRUZ...THE FUN WAY 2017



*Get out of the Bay for Labor Day!*

**Sail San Francisco to Santa Cruz –  
Friday, September 1**

**Racing Division**  
The 70-mile sprint is a great summer end showdown for all Type A's!

**Cruising Division**  
The 70-mile rally with comfortable engine allowance is the laid back way for all Type B's!  
Stay and cruise Monterey Bay

#### **Registration Includes:**

**Regatta, all-night Friday chowder service at SCYC  
and Saturday awards ceremony and party**

**For race information visit: [www.scyc.org/windjammer](http://www.scyc.org/windjammer)**

## ALPHA INDEX

|                                  |       |
|----------------------------------|-------|
| Alphabet Soup .....              | 14    |
| Beer Can Series .....            | 22-25 |
| Caribbean Circuit .....          | 26    |
| Contacts                         |       |
| Associations .....               | 14    |
| <i>Latitude 38</i> .....         | 72    |
| PHRF Committee .....             | 16    |
| YRA .....                        | 8     |
| Yacht Clubs .....                | 12    |
| Contents .....                   | 4     |
| Equipment List .....             | 20    |
| Flags .....                      | 50    |
| Fleet Schedules .....            | 32-33 |
| Marks and Racing Areas .....     | 34-39 |
| Midwinter Series .....           | 28-29 |
| Monthly Calendars .....          | 51-73 |
| PHRF Instructions and Info ..... | 40-49 |
| Pacific Ocean Events .....       | 70    |
| Racing Rules .....               | 18    |
| Season Winners 2016 .....        | 10    |
| Shorthanded Races .....          | 30    |
| Sunrise/Sunset Times .....       | 72    |
| Tidal Current Charts .....       | 74-79 |
| Tidal Current Predictions        |       |
| January-June Weekends .....      | 80    |
| July-December Weekends .....     | 81    |
| VHF Radio Channel Uses .....     | 64    |
| Welcome Letter .....             | 6     |
| Women's Circuit .....            | 68    |
| YRA Races .....                  | 41-47 |
| Youth Sailing .....              | 52-60 |

## ADVERTISER INDEX

|                                  |        |
|----------------------------------|--------|
| Alpha Marine Systems .....       | 31     |
| Alpha Ropes .....                | 77     |
| Bainbridge .....                 | 29     |
| Bay Area Multihull Assn. ....    | 54     |
| Bay Marine Boatworks .....       | 9      |
| Bay View Boat Club .....         | 63     |
| Berkeley Yacht Club .....        | 37, 66 |
| Boome, Chris, Insurance .....    | 51     |
| Boomkicker/Seoladair .....       | 21     |
| Butler Rigging .....             | 71     |
| Cal 20 Fleet .....               | 23     |
| California Offshore Series ..... | 55     |
| Challenge Sailcloth .....        | 64     |
| Corinthian Yacht Club .....      | 12     |
| Davis Instruments .....          | 78     |
| Defender Industries .....        | 22     |
| Dimension Polyant .....          | 32     |
| Doyle Sails .....                | 5      |
| Dry Creek Vineyards .....        | 79     |
| Easom Racing & Rigging .....     | 2-3    |
| El Toro Association .....        | 62     |
| Encinal Sailing Foundation ..... | 11     |
| Euro Marine Trading .....        | 4      |
| Express 27 Fleet .....           | 80     |
| Express 37 Fleet .....           | 66     |
| Golden Gate Yacht Club .....     | 30     |
| Grand Marina .....               | 73     |

|                                                     |        |
|-----------------------------------------------------|--------|
| Hansen Rigging .....                                | 25     |
| Harken .....                                        | 23     |
| Island Yacht Club .....                             | 6      |
| Islander 36 Association .....                       | 66     |
| J/105 Fleet #1 .....                                | 17     |
| KKMI .....                                          | 84     |
| Konocti Bay Sailing Club .....                      | 42     |
| Marchal Sailmakers .....                            | 73     |
| Marina Bay Yacht Harbor .....                       | 62     |
| Mariners General Insurance .....                    | 23     |
| Master Mariners Benevolent Assn. ....               | 81     |
| Modern Sailing School & Club .....                  | 54     |
| Neil Pryde Sails .....                              | 82     |
| New England Ropes .....                             | 19     |
| Oakland Yacht Club .....                            | 8      |
| Outboard Motor Shop .....                           | 78     |
| PICYA .....                                         | 76     |
| Pacific Cup Yacht Club .....                        | 70     |
| Pacific Sail & Power Boat Show .....                | 15     |
| Pantaenius America, Inc. ....                       | 60     |
| Pettit Paint .....                                  | 7      |
| Pineapple Sails .....                               | 52     |
| Pineapple Sails – Musto, Dubarry,<br>Spinlock ..... | 50     |
| Pirate's Lair .....                                 | 14     |
| Quantum Pacific .....                               | 61     |
| Richmond Yacht Club .....                           | 62, 83 |
| Robichaud Batten System, Inc. ....                  | 72     |

|                                                      |    |
|------------------------------------------------------|----|
| Rogue Rigging .....                                  | 19 |
| Sail California .....                                | 16 |
| Santana 22 Fleet .....                               | 66 |
| Sausalito Yacht Club .....                           | 38 |
| Schaefer Marine .....                                | 26 |
| Seashine .....                                       | 80 |
| Sequoia Yacht Club .....                             | 31 |
| Singlehanded Sailing Society .....                   | 69 |
| South Beach Yacht Club .....                         | 65 |
| Spinnaker Cup .....                                  | 37 |
| Stockton Sailing Club .....                          | 59 |
| Sunsail Charters .....                               | 27 |
| Tahoe Yacht Club .....                               | 28 |
| Team McLube .....                                    | 33 |
| Transpacific Yacht Race .....                        | 53 |
| Treasure Island Sailing Center .....                 | 21 |
| Trident Funding .....                                | 67 |
| Twin Rivers Marine Insurance .....                   | 18 |
| Tylaska .....                                        | 75 |
| UK Sailmakers .....                                  | 21 |
| Ullman Sails – San Francisco &<br>Monterey Bay ..... | 58 |
| Vallejo Marina .....                                 | 56 |
| Vallejo Yacht Club .....                             | 57 |
| Waterat .....                                        | 26 |
| Westwind Precision Details .....                     | 72 |
| Wichard Sparcraft, Inc. ....                         | 13 |
| Windjammer Yacht Club .....                          | 82 |



# ROCKS!

## REGATTAS

SMALL BOAT MIDWINTERS *Dec, Jan, Feb, Mar @ Dec*  
 SAIL A SMALL BOAT DAY *March*  
 BIG DADDY *March*  
 BIG DINGHY *April*  
 INT'L 14 NORTH AMERICAN CHAMPIONSHIP *August*  
 MULTIHULL *September*  
 TOTALLY DINGHY *September*  
 SPORT BOAT INVITATIONAL *October*  
 GREAT PUMPKIN *October*  
 AMAZING GRACE *November*  
 LASER/BYTE SHORT COURSE *November*  
 BEER CAN races with over 25 boats *April - September*  
 JUNIOR PROGRAM *All year long*



**RICHMOND YACHT CLUB**  
 richmondyc.org  
 510.237.2821  
 EMAIL [gail.yando@sbcglobal.net](mailto:gail.yando@sbcglobal.net)



# We serve WINNERS!!

**KKMI is - hands down - the Bay Area's leader in servicing winning boats!**

From super-slippery bottom jobs to finely tuned rigging, KKMI is the leading boat yard to give you and your winning team a leg up - to the podium!!

BAY AREA'S HEADQUARTERS FOR FAST BOTTOMS,  
TUNED RIGGING, & MUCH MORE!



PT. RICHMOND (510) 235-5564

[WWW.KKMI.COM](http://WWW.KKMI.COM)

SAUSALITO (415) 332-5564