

Latitude 38

# Latitude 38

VOLUME 386 August 2009

WE GO WHERE THE WIND BLOWS

AUGUST 2009

VOLUME 386

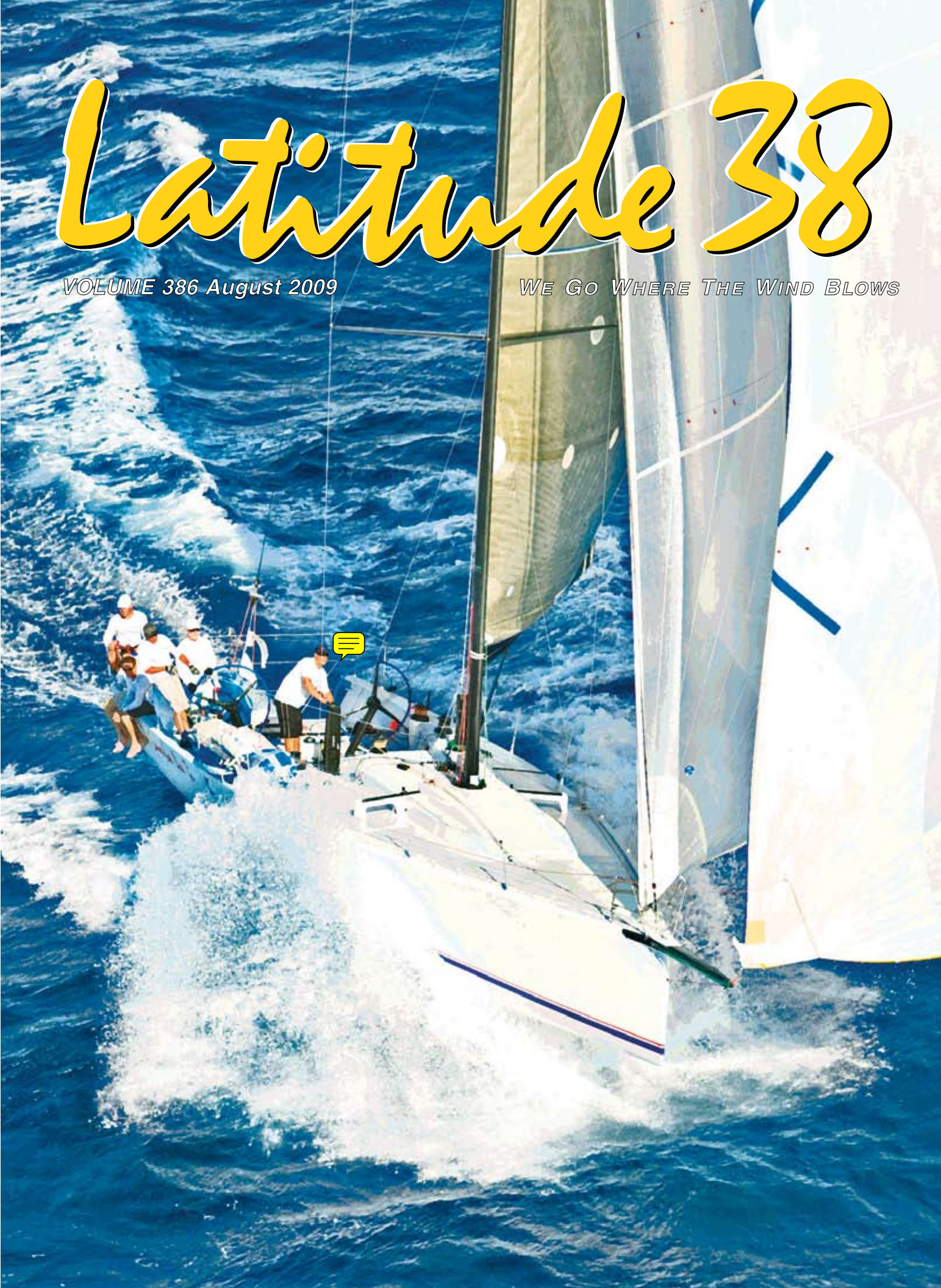



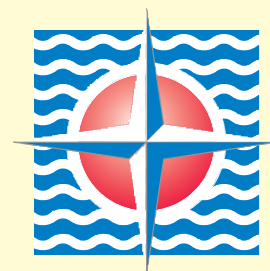

Photo- Karl Wilbur

***A perfect ending to a hot August day.  
Grand Marina - simply beautiful.***

- Prime deep water concrete slips in a variety of sizes
- Great Estuary location at the heart of the beautiful Alameda Island
- Complete bathroom and shower facility, heated and tiled
- FREE pump out station open 24/7
- Full Service Marine Center and haul out facility
- Free parking
- Free WiFi on site!
- And much more...

<b>DIRECTORY of GRAND MARINA TENANTS</b>	
Alameda Prop and Machine.....	162
Bay Island Yachts .....	10
Blue Pelican Marine.....	168
The Boat Yard at Grand Marina...	13
Lee Sails.....	172
Marine Lube.....	170
Pacific Crest Canvas.....	67
Pacific Yacht Imports .....	9
Rooster Sails .....	97
UK-Halsey Sailmakers.....	54



**GRAND MARINA**  
ANDERSON-ENCINAL

**510-865-1200**

Leasing Office Open Daily  
2099 Grand Street, Alameda, CA 94501  
[www.grandmarina.com](http://www.grandmarina.com)



# On, Vixen!

PHOTO: MARIAH'S EYES PHOTOGRAPHY (510) 864-1144



**Vixen\***

It all started when Linda Kibler decided to give her husband, Steve, a spinnaker for Christmas a few years ago. The Kiblers were restoring a classic 1904 Custom yawl, *Vixen*, and at the time the restoration was nearing completion.

Steve was certainly pleased with the thought of the new spinnaker for *Vixen* - and a new main and a new mizzen and a new self-tacking jib. So he added to Linda's sail order and, after careful measurements were taken, the boat had a new suit of Pineapple Sails.

This year *Vixen* won her division in the Master Mariners Regatta, an event sailed on San Francisco Bay that was started in the late 1800's and revived for these great old classics in the 1960's.

*Vixen* is unique, a real labor of love for Steve and Linda.

We feel the same about every sail we make. We invite you to come by the Pineapple Sails loft to see sails being made right here in Alameda and to meet the folks making them. Whether your boat is new, over 100 years old, or somewhere in between, we build all our sails - your sails - with the same care and expertise.

YOUR DEALER FOR: Musto foul weather gear, Dubarry footwear and Headfoil 2

Sails in need of repair may be dropped off at:  
West Marine in Oakland, Alameda, or Richmond;  
or Svendsen's in Alameda.

\*Powered by Pineapples



## **PINEAPPLE SAILS**

Phone (510) 522-2200

Fax (510) 522-7700

[www.pineapplesails.com](http://www.pineapplesails.com)

2526 Blanding Ave., Alameda, California 94501



For unsurpassed taste  
**PUSSER'S®**  
 THE NO. 1 NAVY RUM  
 THE ORIGINAL SINCE 1655

Forbes writes, "Pusser's is still made in the same way it was at the time of Trafalgar - in wooden pot-stills as opposed to modern industrial column-stills. This results in the most full-flavored rum available anywhere".



Gold Medals: London 2001, San Francisco 2003 & 2005, International Rum Festival 2008, Rum Masters, London 2009



Like no other rum, PUSSER'S taste is said to have the character of a single malt whiskey or a fine brandy. This comes from its rich content of wooden pot stillled rum that imparts a taste that is uniquely rich and flavorful. And it's natural. No flavoring agents are used. This PUSSER'S taste punches pleasingly through whatever mix you may use. *BUT* it's also great for sipping! Try it neat, or "take the test and taste the difference"! Mix it with your favorite cola and compare it to any other rum and cola and discover the mellow, pleasing character of PUSSER'S.

**Liquid History** is another name for PUSSER'S RUM. PUSSER'S, the father of navy rum and the original 'grog', was issued to the sailors of Great Britain's Royal Navy for over 300 years from about 1655 to July 31st, 1970.

For those who enjoy tradition, some sea time (when they can get it) and a good drink afterwards, what could be more traditional and taste better than PUSSER'S - the most traditional of all sea drinks.

For more on PUSSER'S and HOW TO FIND IT:  
[www.pussers.com](http://www.pussers.com)

IMPORTED BY SHAW-ROSS INT'L IMPORTERS, MIAMI, FL. PUSSER'S RUM 42% ALC/VOL

## CONTENTS

subscriptions	6
calendar	20
letters	28
sightings	74
transpac 2009	88
delta doo dah	98
solo sensation	104
puddle jump recap	108
danish delights interview	116
max ebb: the best a-cup ever	122
the racing sheet	126
world of chartering	136
changes in latitudes	144
classy classifieds	160
advertisers' index	171
brokerage	175

Cover: Hoist the Broomstick! - It was a clean sweep for John Kilroy Jr.'s TP 52 *Samba Pa Ti* in this year's TransPac.

Photo: Sharon Green/www.ultimatesailing.com

Copyright 2009 Latitude 38 Publishing Co., Inc.

Latitude 38 welcomes editorial contributions in the form of stories, anecdotes, photographs - anything but poems, please; we gotta draw the line somewhere. Articles with the best chance at publication must 1) pertain to a West Coast or universal sailing audience, 2) be accompanied by a variety of pertinent, in-focus digital images (preferable) or color or black and white prints with identification of all boats, situations and people therein; and 3) be legible. These days, we prefer to receive both text and photos electronically, but if you send by mail, anything you want back must be accompanied by a self-addressed, stamped envelope. **Submissions not accompanied by an SASE will not be returned.** We also advise that you not send original photographs or negatives unless we specifically request them; copies will work just fine. Notification time varies with our workload, but generally runs four to six weeks. Please don't contact us before then by phone or mail. Send all submissions to [editorial@latitude38.com](mailto:editorial@latitude38.com), or mail to Latitude 38 editorial department, 15 Locust Ave., Mill Valley, CA 94941. For more specific information, request writers' guidelines from the above address or see [www.latitude38.com/writers.html](http://www.latitude38.com/writers.html).



## Brokerage ■ Staff Picks



**Beneteau 393 2003**  
Very clean, with new bottom paint, inverter, dodger, windlass, A/C and more. Motivated seller. \$139,500



**Beneteau 45f5 1991**  
Farr designed performance cruiser. New sails, NKE system, SSB, AP, laptop nav system, dodger, more. Very good condition. \$160,000



**Tartan 4400 2005**  
Ready to cruise, beautiful and well equipped. Health forces sale. Owner will consider trades/partial financing. \$449,000



**Hunter Legend 450 1998**  
Big boat at a great price. Ready to cruise with generator, A/C, TV, AP, radar, GPS, inverter, more! \$179,000



**Beneteau 351 1995**  
Maintained in perfect condition. Roomy and comfortable interior – like new. \$73,500



**X-412 2001**  
Like new condition. Flag blue hull. Euro craft meets high performance. \$219,000

Beneteau 49, '07 .....BYC...339,000  
Beneteau First 47.7, '01 .....SAU...228,000  
Beneteau 473 .....AMV...259,900  
Beneteau 473 .....AMV...326,500  
Explorer 45, '79 .....AMV...130,000  
Beneteau 423, '04 .....SAU...185,000  
Beneteau 43, '08 .....BYC...239,000  
Tayana Vancouver 42, '79 ..AMV... \*79,500  
Sunnfjord 42, '81 (power)...AMV...108,000  
Californian 42, '87 (power)...AMV...119,950  
Cascade 41, '71 .....AMV... \*59,500  
Island Packet 40, '98.....EMR...269,000  
Carroll Marine 1200, '95.....RYC.....89,000  
Beneteau 393, '07 .....AMV...175,000  
Wauquiez Hood 38\*, '79.....AMV.....59,000  
Island Packet 370, 04.....RYC...299,000  
Islander Freeport 36, '78 ....AMV.....45,000  
Beneteau First 36.7, '05 .....LAX...112,000  
CS 36, '84.....EMR.....55,000  
Fantasia 35, '79 .....AMV.....74,500  
J/109, '03 .....BYC...192,900  
Beneteau 331, '04 .....BYC.....85,000  
Sea Ray 340, '06 (power) ...AMV...174,500  
Tiara 29, '98 (power).....AMV.....69,900

\*Owner financing available

## Join us August 15 for our Island Packet Demo Day!



37' ESTERO

Come experience firsthand the elegance and uncompromising craftsmanship of the Island Packet line of cruising sailboats. Find out why these boats have a following whose dedication borders on zeal. Practicality, efficiency, safety, and a precise attention to detail make every aspect of the Island Packets border on perfection.

### Join us on Saturday, August 15

- Demo rides on the new Estero
- Full line of Island Packets on display
- Leaseback Opportunities Available
- Cruising Seminars (check our website for schedule)
- Barbecue
- Product demonstrations

Please call **(510) 236-2633** to RSVP for this event as sailing space is limited.

**Full line: 485 • 465CC • 460 • SP Cruiser 41 • 37 • Estero**

## We make boat buying fun... Since 1982



Since 1982, Passage Yachts has been providing sailors with the help and services they need to realize their sailing aspirations. We have helped people find the right boat to cruise or race the Bay, the coast and beyond.

The lines we represent reflect our focus and commitment to providing excellent value and a lifetime of service.

### Our Goals and Commitment:

- To find you the perfect boat for your budget and use, not fit you into something at our docks.
- To handle all the details of a new or used boat purchase from finding the right boat to financing to equipping and/or upgrading – and all within your budget.
- To provide the best customer care and service from our experienced sales staff and award-winning service department.
- To make buying your boat – new or used – one of the best experiences of your life.



FOR THE TIME OF YOUR LIFE

Pt. Richmond  
Office

Two  
Locations!

Alameda Office  
Marina Village

1220 Brickyard Cove Rd  
p: 510-236-2633  
f: 510-234-0118

1070 Marina Village Pkwy  
Suite 101  
p: 510-864-3000  
f: 510-337-0565

www.passageyachts.blogspot.com ■ www.passageyachts.com

BENETEAU

ISLAND PACKET

ALERION EXPRESS

WAUQUIEZ



# BOAT LOANS

from



Trident Funding

*"a fresh  
approach  
from people  
you can trust"*

*In Northern California call*  
**JOAN BURLEIGH**  
**(800) 690-7770**

*In Southern California call*  
**JEFF LONG**  
**MARGE BROOKSHIRE**  
**(888) 883-8634**

*In San Diego call*  
**MIKE LOCKARD**  
**(619) 255-5666**

[www.tridentfunding.com](http://www.tridentfunding.com)

## SUBSCRIPTIONS

Please read form carefully before submitting.

We regret that we cannot accept foreign subscriptions.

Check, money order, or credit card information must accompany request.

Please allow 4-6 wks to process changes/additions, plus delivery time.

### eBooks are now free!



Check out [www.latitude38.com](http://www.latitude38.com) and click on eBooks to see what we're talking about. Our eBooks are in PDF format, easy to use with Adobe Reader

### Enclosed is \$36 for one year Third Class Postage

(Delivery time 2-3 weeks; Postal Service will not forward third class, so you must make address change with us in writing.)

### Enclosed is \$55 for one year First Class Postage (Delivery time 2-3 days; FPO/APO (military), Canada & Mexico subscriptions are first class only)

### Third Class Renewal First Class Renewal (current subs. only!)

### Gift Subscription – Card to read from: \_\_\_\_\_

Name \_\_\_\_\_

Address \_\_\_\_\_

City \_\_\_\_\_ State \_\_\_\_\_ Zip \_\_\_\_\_

Phone: ( ) \_\_\_\_\_ Email: \_\_\_\_\_

**CREDIT CARD INFORMATION**  MASTERCARD  VISA  AMERICAN EXPRESS  
Min. Charge \$12 Number: \_\_\_\_\_ Exp.: \_\_\_\_\_ csv: \_\_\_\_\_

### INDIVIDUAL ISSUE ORDERS

Current issue = \$6.00 • With classy ad placed = \$5.00

Back Issues = \$7.00 (must indicate exact issue by month or vol. #)

### DISTRIBUTION

We have a marine-oriented business/yacht club in California which will distribute copies of *Latitude 38*. (Please fill out your name and address and mail it to the address below. Distribution will be supplied upon approval.)

Please send me further information for distribution outside California

Business Name \_\_\_\_\_ Type of Business \_\_\_\_\_

Address \_\_\_\_\_

City \_\_\_\_\_ State \_\_\_\_\_ Zip \_\_\_\_\_

County \_\_\_\_\_ Phone Number \_\_\_\_\_

# Latitude 38

*"we go where the wind blows"*

Publisher/Exec. Editor..... Richard Spindler..... richard@latitude38.com .....ext. 111  
Associate Publisher..... John Arndt..... john@latitude38.com .....ext. 108  
Managing Editor..... Andy Turpin..... andy@latitude38.com .....ext. 112  
Editor..... LaDonna Bubak..... ladonna@latitude38.com .....ext. 109  
Racing Editor..... Rob Grant..... rob@latitude38.com .....ext. 105  
Contributing Editors..... John Riise, Paul Kamen  
Advertising Sales..... John Arndt..... john@latitude38.com .....ext. 108  
Advertising Sales..... Shawn Grassman..... shawn@latitude38.com .....ext. 107  
General Manager..... Colleen Levine..... colleen@latitude38.com .....ext. 102  
Production/Web..... Christine Weaver..... chris@latitude38.com .....ext. 103  
Production/Photos..... Annie Bates-Winship... annie@latitude38.com .....ext. 106  
Bookkeeping..... Helen Nichols..... helen@latitude38.com .....ext. 101

Directions to our office .....press 4  
Subscriptions.....press 1,4  
Classified.....class@latitude38.com.....press 1,1  
Distribution.....distribution@latitude38.com.....press 1,5  
Editorial.....editorial@latitude38.com.....press 1,6  
Calendar.....calendar@latitude38.com  
Other email.....general@latitude38.com

Please address all correspondence by person or department name

15 Locust Avenue, Mill Valley, CA 94941 • (415) 383-8200 Fax: (415) 383-5816  
[www.latitude38.com](http://www.latitude38.com)



**Catalina**  **Yachts**

F A R A L L O N E



*Finalize Your Dream...*



**New Catalina 445!**

*The closer you look the better we get!*



**Celebrating!**

**40th Anniversary of Catalina Yachts  
35th Anniversary of Farallone Yacht Sales**

**Experience counts!**



NEW 29' Ranger Tug

**New Catalina's In Stock**



**Worlds Largest Catalina Yacht Dealer!**

**Preowned Catalina Yachts**

Catalina 470	2006	\$399,900
Catalina 440	2005	\$331,900
Catalina 42	2001	\$185,000
Catalina 42	2006	\$239,900
Catalina 42	1992	\$127,000
Catalina 400	2001	\$189,000
Catalina 380	1998	\$127,000
Catalina 380	2000	\$129,000
Catalina 380	1999	\$127,000
Catalina 36	1989	\$52,900
Catalina 36	1987	\$59,000
Catalina 36	1990	\$65,900
Catalina 36	2002	\$119,000
Catalina 350	2004	\$139,800
Catalina 320	2001	\$86,000
Catalina 310	2007	\$115,000
Catalina 280	2004	\$65,500
Catalina 280	1999	\$50,000

**Preowned Sailing Yachts**

Hunter 466	2000	\$219,500
Cavalier 45	1985	\$255,000
Morgan 45CC	1992	\$159,000
Hunter 450	2000	\$189,000
Endeavour 43	1980	\$139,900
Jeanneau 43DS	2002	\$235,000
Hunter Passage CC 42		
	1996	\$144,900
Bavaria 42	2006	\$189,900
Jeanneau 42DS	2005	\$249,000
Fountaine Pajot 42	1995	\$269,000
Hunter 41	2004	\$165,000
Hunter 41	2004	\$179,000
Morgan 38	1979	\$57,500
Tayana 37	1979	\$59,000
C&C 37+	1990	\$99,000
Hunter 36	2004	\$125,000
Hunter 36	2006	\$135,000

Jeanneau 36	2008	\$159,000
Wylie 36	1978	\$57,500
Hunter 35.5	1993	\$59,000
Hunter 34	1998	\$79,000
Nantucket 33	1984	\$49,950
Irwin 34	1985	\$29,000
Seawind Cat 33	1997	\$139,000
Cheoy Lee 32	1977	\$36,500
Hunter 306	2004	\$59,500

**Preowned Power Yachts**

Trojan II Meter Express 37		
	1988	\$49,900
Carver Santiago	1990	\$39,000
Regal 2860	2004	\$57,000

**New Ranger Tugs in Stock**

Ranger 29 Tug	2009	\$214,937*
Ranger 25 Tug	2009	\$137,937*
Ranger 21-EC Tug	2010	\$49,937*

\*Base price.

1070 Marina Village Pkwy.  
Alameda CA 94501  
510 • 523 • 6730



2353 Shelter Island Drive  
San Diego CA 92106  
619 • 523 • 6730

ALAMEDA • NEWPORT BEACH • SAN DIEGO  
www.faralloneyachts.com



# Yachtfinders/Windseakers

in the heart of  
San Diego's boating community

2330 Shelter Island Dr. # 207, San Diego, CA 92106

info@yachtfinders.biz

(619) 224-2349

Toll Free (866) 341-6189

Go to  
[www.yachtfinders.biz](http://www.yachtfinders.biz)  
for all our 80+ listings!



**52' SANTA CRUZ, '93** \$450,000  
Impeccably maintained. Two-stateroom layout. Tall carbon fiber mast, fractional jibs, masthead spinnakers.



**47' KETTENBURG M/S, '58** \$99,000  
She has since been fully restored and refurbished with modern amenities, and provides the best of both eras.



**43' BENETEAU 432, '87** \$139,000  
The swim platform makes dinghy and water entry easy, and with lines led aft to the cockpit, she is effortlessly sailed.



**38' ERICSON, '84** \$64,900  
Respectable performance in a solidly-built boat, and a comfortable layout with two private staterooms.



**37' JEANNEAU 37.1, '95** \$98,500  
Her shoal draft makes it possible to get into those choice shallow spots not available to other sailboats.



**36' CATALINA MKII, '05** \$129,500  
Very lightly-used vessel voted San Diego Yacht Club's Best Maintained Sail Yacht 2009. She won't disappoint!



**35' CAL MKIII, '81** \$42,000  
Bullet-proof hull and deck joints. This handsome yacht is a capable cruiser while retaining her racer abilities.



**35' FANTASIA CC, '78** \$38,000  
In the heavy going she will have a comfortable motion, and she will surge smoothly through big seas.



**35' ERICSON MKIII, '83** \$58,900  
*White Star* has been passionately maintained. She is a swift, stable day-sailer and dependable cruiser.



**34' HUNTER 34.5, '85** \$41,000  
This boat has enjoyed a flawless and well-thought out refit. Don't miss this one unless you hate yourself.



**32' CATALINA 320, '95** \$62,500  
She'll comfortably take the family to the islands or be happy on the Bay. Possible owner financing available.



**30' NONSUCH ULTRA, '84** \$49,900  
Biggest 30-footer afloat. The roomy interior and the easy-to-handle cat rig make it a desirable family cruiser.



**\$95K Ready to Sail**

LOA	LWL	Beam	Draft	Displ.	Spar
27' 10"	25' 0"	7' 6"	6' 0"	4,073	Carbon

Introducing the LS-30 performance daysailer from The Landing School. Only two available annually.

landingschoolboats.com

207-985-7976

## THINK

*Just say no to boxy dodgers!*

**BEFORE:**  
The Box



**AFTER:**  
Beyond  
the Box

**STARBUCK**



**CANVAS WORKS**

67 Liberty Ship Way  
Sausalito, CA 94965

**415•332•2509**



# Exclusive West Coast Dealer for Tayana Yachts



## TAYANA 54 DECK SALON AT OUR DOCKS



### SELECT BROKERAGE



#### 1997 TARTAN 4600

Must see! Custom Kevlar reinforced hull. Beautifully maintained with a huge inventory of equipment and sails. **\$390,000**



#### 2007 TAYANA 46 PILOTHOUSE

Cruise in comfort in any climate with inside steering. With only 12 hours on Yanmar 100 hp dsl, she's virtually new. Over 1,000-mile range under power. **\$369,000**



#### 2005 TAYANA 48 DECK SALON

Like new with only 71 hrs on Yanmar. Raymarine electronics, air/heat, genset, Corian, LeisureFurl main, electric winches. **\$489,900**



#### 2005 TAYANA 48 CC

Just back from Mexico in great shape with everything you need for this year's Baja Ha-Ha. **\$469,000**



#### 2007 TAYANA 48 DECK SALON

*Calmate* has a beautiful LPU navy hull and is loaded with gear. Radar arch, davits, Leisurefurl boom, electric winches, full canvas and up to date electronics. **\$525,000**



#### 1973 C&C 48 SLOOP

Great ex-racer refit at the factory with a new interior, wiring, rod rigging and Perkins MT 80. **\$175,000**



#### 1988 FRASER 51 CUTTER

*Wingstar* is a Canadian-built center cockpit cutter. Great shape and ready to go again. **\$229,000**



#### 1990 TAYANA 55

Well cared for and consistently upgraded. New teak decks in 2006. New engine 2008. Lying Turkey. **\$360,000**



#### 1973 BREWER 43 CC KETCH

Custom center cockpit teak ketch properly maintained by a meticulous owner. **\$69,000**



#### 1978 TARTAN 30

Clean, well taken care of example of this timeless S&S design. **\$15,500**



#### 1969 COLUMBIA 43 SLOOP

An oldie but a goodie. *Sunflower* is set for cruising with chartplotter, radar, solar panels, davits and Givens 6-man liferaft. **\$47,500**



#### 1982 TAYANA 42 CC

Well cared for and well equipped bluewater cruiser. Great layout with loads of storage and a separate stall shower in aft head. **\$129,500**

# Pacific Yacht Imports

2051 Grand Street, Alameda, CA 94501

[www.pacificyachtimports.net](http://www.pacificyachtimports.net)

We're at Grand Marina

Dave Wolfe • Neil Weinberg

Tel (510) 865-2541 Fax (510) 865-2369

[tayana@mindspring.com](mailto:tayana@mindspring.com)





# Bay Island YACHTS

VISIT US ONLINE AT [WWW.BAYISLANDYACHTS.COM](http://WWW.BAYISLANDYACHTS.COM)

### NONSUCH 33



1989, \$125,000

### FOUNTAIN PAJOT 43



2002 Belize, \$350,000

### NONSUCH 30 ULTRA



1984, \$65,900

### HUNTER 45



1988. Reduced! \$79,500

### PEARSON 32



1982. Very clean. \$24,500

### CATALINA 34



1988, \$43,900

### FORMOSA 51



1977, \$110,000

### NEWPORT 33



1984. Very clean! \$35,900

### 32' COLUMBIA 9.6



1979, \$13,000

### CATALINA 36



2002, INQUIRE

**(510) 814-0400**

Fax (510) 814-8765

2099 Grand Street, Alameda, CA 94501

[www.bayislandyachts.com](http://www.bayislandyachts.com)

[yachtsales@bayislandyachts.com](mailto:yachtsales@bayislandyachts.com)

**YACHTWORLD.com**



# BOATSMITH, INC.

BOATBUILDING ~ MARINE CARPENTRY



*Specializing in composite wood construction*

Authorized builders for James Wharram Designs and Reuel Parker. We can build to any design you desire.

**561.744.0855 | 561.632.2628**

[www.boatsmithfl.com](http://www.boatsmithfl.com)

Jupiter, Florida

## GARMIN

# Blow Out



**GP 3210**  
10.4" color LCD  
with charts

**\$1175**



**GP 3206**  
6" color LCD  
with charts

**\$859**



**GP 3205**  
5" color LCD  
with charts

**\$709**

Santa Cruz  
(831)  
475-3383

**JohnsonHicks**  
MARINE ELECTRONICS

Sausalito  
(415)  
331-3166

# Cityyachts

San Francisco's yacht broker since 1969

## YACHTS AND THE CITY



Cabo Rico 38, '81 \$80,000



Hylas 42, '89 \$165,000



32' Grand Banks, '80 \$89,900



Catalina 34, '94 \$70,000



30' Knarr, '84 \$25,000



36' Islander, '75 \$38,500



28' Bayliner 2855, '00 \$44,500



Carver 30, '93 \$59,900



35' Maxum, '02 \$190,000



34' Irwin, '80 \$23,800



35' Niagara, '80 \$58,500



46' Moody, '00 \$399,000



42' Fountaine Pajot Venezia, '95, \$230,000



47' Chris Craft Commander, '74 \$199,000



51' Morgan Out Island, '82 \$135,000

10 MARINA BL. • SAN FRANCISCO, CA 94123 • Toll Free: 877-444-5091 • 415-567-8880  
FAX (415) 567-6725 • email [sales@citysf.com](mailto:sales@citysf.com) • website <http://yachtworld.com/cityyachts>



PLEASE VISIT OUR FUEL DOCK AT GASHOUSE COVE MARINA • OPEN 7 DAYS A WEEK • 9AM TO 5PM





## Cruising Yachts, Inc.

(888) 78-YACHT (619) 681-0633 (949) 650-7245  
Alameda San Diego Newport Beach

**WE'VE EXPANDED! Now in Southern California!**  
**NEW offices in San Diego & Newport Beach!**  
With multiple locations and a huge inventory of new & used,  
nobody offers you more choices for your next sailboat!

Proudly Representing



### New Sailboats

2010 Jeanneau 57	CALL
2009 Jeanneau 54DS	\$549,900
2009 Hunter 50 CC	CALL
2009 Jeanneau 50DS	CALL
2009 Hunter 49	CALL
2009 Jeanneau 49i	CALL
2009 Hunter 45	CALL
2009 Jeanneau 45DS	CALL
2008 Jeanneau 45DS	CALL
2009 Jeanneau 44i	CALL
2008 Jeanneau 44i Prf.	CALL
2009 Jeanneau 42DS	CALL
2009 Hunter 41DS	CALL
2009 Jeanneau 39DS	CALL
2009 Jeanneau 39i	CALL
2008 Jeanneau 39i	\$237,725
2009 Hunter 38	CALL
2009 Hunter 36	CALL
2009 Hunter 33	CALL
2009 Jeanneau 32	CALL
2009 Jeanneau SunFast	CALL
2009 Hunter 31	CALL
2008 Hunter 31	CALL

### Brokerage Boats

2005 Jeanneau 54DS	\$650,000
2008 Hunter 45CC	\$340,000
2006 Jeanneau 45	\$329,500
2006 Jeanneau 45	\$319,000
2007 Hunter 44DS	\$199,995
2005 Hunter 44DS	\$210,000
2003 Jeanneau 43DS	\$228,000
1998 Catalina 42	\$148,000
2000 Hunter 42	\$165,000
2005 Hunter 41 DS	\$187,500
2000 Jeanneau 40	\$149,000
1996 Hunter 375	\$89,900
1991 Hunter 37	\$74,900
2003 Beneteau 361	\$94,950
1986 Freedom 36	\$79,900
2007 Hunter 36	\$149,995
2004 Hunter 36	\$114,995
1992 Solaris 36	\$99,990
1996 Bayliner 3485	\$49,995
1997 Catalina 34	\$79,500
2000 Hunter 340	\$76,000
1999 Hunter 340	\$83,500
2006 Nordic Tug 32	\$237,500
1999 Hunter 310	\$44,995

### Featured Boats of the Month!



**2003 Beneteau 361** - Very clean, one-owner boat with low engine hours. She has been berthed in fresh water since new. She has a very functional 2-cabin interior, excellent galley with frig & freezer, gorgeous woodwork & more. And, best of all, she's priced to sell!

**Our Trade-in! Asking \$94,950**



**1998 Catalina 42 MKII** - Reduced Price! This late model two cabin pullman style model has been very nicely maintained. Well equipped for comfortable cruising. Owner is a 2 boat owner who is very motivated to sell! This boat must go! Contact Ian in the San Diego Office.

**Asking \$148,000**

[www.cruisingyachts.net](http://www.cruisingyachts.net)

**SAVE**  
on North Sails  
quality, durability  
& performance!

**NORTH SAILS**  
**direct**

It's easy to measure your own boat  
and SAVE on the world's best  
cruising and racing sails. Log on to  
[northsailsdirect.net](http://northsailsdirect.net)  
or call **888-424-7328**.

Free tape  
measure  
with every  
order!

## Sail Mexico Aboard the Schooner Seaward Winter 2010

Answer the 'Call of the Sea'  
Adventure Voyages to Mexico's Sea of Cortez  
[www.SeawardAdventures.org](http://www.SeawardAdventures.org)

Be part of the adventure. This is a hands-on opportunity for all levels of sailors to enjoy the pristine beauty of Baja and camaraderie with your shipmates.



Contact us  
now! Limited  
Availability!

Channel Islands from Los Angeles	Jan 5-10	\$1,000
Los Angeles to Cabo San Lucas	Jan 14-26	\$1,350
La Paz to Cabo San Lucas	Feb 19-24	\$1,100
Cabo to San Francisco	Feb 24-Mar 13	\$850

[www.SeawardAdventures.org](http://www.SeawardAdventures.org) • (415) 331-3214

These trips share the hands-on educational spirit of Call of the Sea's mission and help support our Youth Programs. Seaward is an 82-ft USCG-inspected vessel owned by Call of the Sea, a non-profit educational organization.

[www.callofthesea.org](http://www.callofthesea.org) • [info@callofthesea.org](mailto:info@callofthesea.org)

# THE BOAT YARD AT GRAND MARINA

"Where Service Has Meaning"

**SHE'S  
BACK...**

*Headquarters  
for the exclusive*

**"SUPER  
COTE"  
BOTTOM  
JOB**

*There's No Finer  
Bottom  
Than Ours!\**

Call today to  
schedule your  
2009 haulout,  
bottom, fiberglass,  
engine, rigging and  
LPU work.

\*Well almost none.



**Interlux**  
yachtpaint.com

**AWLGRIP**  
THE EXPERT

FEATURING  
TRINIDAD  
ANTI-FOULING PAINT BY  
**PETTIT**  
marine paint  
RATED "SUPERIOR" by  
Practical Sailor

*The only yard to brush on your bottom paint!*

**IT'S SIMPLE!**

**Call The Boat Yard at Grand Marina for the Lowest Bottom Prices!**

~ COMPARE US WITH THE COMPETITION ~

- Prop and Shaft Work
- Mast & Rigging Repair
- Fiberglass & Blister Repair
- Gelcoat Repair
- Gas & Diesel Engine Service
- LPU Hull & Topside
- Electrical Repair & Installation

**CALL FOR A RESERVATION**

**(510) 521-6100 • Fax (510) 521-3684**

**Located at Grand Marina • 2021 Alaska Packer Place, Alameda**

**www.boatyardgm.com**

**Dealers for:**

**MAX-PROP**  
AUTOMATIC FEATHERING PROPELLERS

**GOR!**  
marine

**Webasto**  
PACKLESS SEALING SYSTEM  
**SHAFT SEAL**

**Lectra/san**

**SIDE-POWER**  
Thruster systems

**facnor**  
FURLING SYSTEMS INC.

**AQUAMARINE**  
FINE REVERSE OSMOSIS EQUIPMENT



**Welcome Golden Gate Charter!**



Discover  
Brisbane  
Marina

Call Grant Gilliam for  
charter information.  
(650) 773-3311



Brisbane Marina would like to welcome  
Golden Gate Charter, LLC,  
to our line of services.  
Call Grant today at (650) 773-3311  
grant@ggcharter.com  
www.ggcharter.com



From Hwy 101, take the Sierra Point Pkwy  
exit and follow the signs to the marina.

400 Sierra Point Parkway  
Brisbane, CA 94005  
(650) 583-6975  
www.ci.brisbane.ca.us  
harbormaster@ci.brisbane.ca.us



Ray Watson & Jeannette Sarrasin  
Toll free US/CAN: 1 (888) 716-7430  
Phone & FAX: 011 52 (669) 913-3165  
E-mail: Mazmarine@aol.com



Mike Rickman & Shelly R. Ward  
Toll free US/CAN: 1 (877) 245-9689  
Phone & FAX: 011 52 (612) 123-1948  
E-mail: LaPazYachts@aol.com



www.yachtworld.com/mazmarine



54' HUNTER SLOOP 1983...\$90,000



47' CATALINA SLOOP, 1999...\$244,000



45' HUNTER 450 PASSAGE CC, 1998...\$165,000



41' MORGAN OI 415 CC KETCH, 1979...\$69,900



40' ROBERTS CC CUTTER SLOOP, 1980...\$87,000



39' CAL, 1980...\$74,900



38' FOUNTAINE PAJOT ATHENA CATAMARAN, 1995...\$174,500



32' WESTSAIL CUTTER, 1981...\$63,500



31' BROWN SEARUNNER TRI, 1978...\$32,000

MANY MORE LISTINGS ON OUR WEBSITE AT WWW.MAZMARINE.COM



## LET'S BE CLEAR ABOUT IT...

**"Dumping sewage anywhere in  
our waterways pollutes the  
environment."**

Disease, contamination, low oxygen levels and unsightly water are just a few of the devastating effects of boat sewage illegally dumped anywhere in our waterways and shoreline.

It's simple: You have to plan to properly dispose of human sewage from your boat. Boats with holding tanks must pull in and pump out at shore side pump out stations.

If you have a boat without holding tanks, plan your trip to use shore side restroom facilities.

Don't waste away our waterways! Proper disposal of sewage allows the living things in our waterways to keep on living.

**IF IT'S YOUR BOAT,  
IT'S YOUR RESPONSIBILITY.**

California Department of Boating and  
Waterways



For more information visit our website  
[www.BoatResponsibly.com](http://www.BoatResponsibly.com)





# FREEDOM

FROM HIGH MAINTENANCE COSTS

## SAN FRANCISCO BOAT WORKS

835 Terry A. François St., San Francisco, CA 94158  
(415) 626-3275 Fax (415) 626-9172

**CALL US - SEVEN DAYS A WEEK!**

Be our guest for lunch at the historic Ramp Restaurant\*

\*Some restrictions apply



# SUMMER HEAT MEANS HOT DISCOUNTS!

*And we're always available!*

**REQUEST A HAUL-OUT  
ONLINE!**

**ORDER PARTS  
ONLINE!**

[www.sfboatworks.com](http://www.sfboatworks.com)

## PortVisor™

Shield opening ports from rain

- Keep ports open in the rain
- Air out cabin and head
- Maintain visibility
- Increase boat's comfort
- Install easily, without tools
- Enjoy life aboard more often



Many sizes for aluminum, bronze, stainless, and plastic portholes.  
Made from clear UV-resistant Lexan with bronze tint.

www. **Seaworthy Goods** .com  
*Smart Stuff. Smart Boats.*  
**(941) 448-9173**

## KISSINGER CANVAS

*Marine Canvas & Interiors*

STEVEN KISSINGER

**(925) 825-6734**

*Covering the Entire Bay Area*



- Biminis
- Boat Covers
- Cushions
- Sail Covers
- Headliners
- Awnings

## DODGERS

Side handrails and window covers  
included.

### OPTIONS

Aft handrail, dodger cover,  
sailing bimini.

*Free Estimates and Delivery*



## Want some time away?

You don't have to go far. Come to Jack London Square for our weekend package. The package includes one night slip fees at Jack London Square, a \$100 coupon for Scott's Seafood or Kincaid's Restaurant and two movie tickets. All within two blocks. At \$135 inclusive it's the best value on the bay. We'll even deliver the Sunday paper to your boat. Call for reservations and enjoy a boating weekend close to home.



- \*Restaurants
- \*Movies
- \*Shopping
- \*Farmers Market

## JACK LONDON SQUARE



Oakland Marinas  
1853 Embarcadero St., Suite 2A  
Oakland, CA 94606  
510.834.4591  
slips@oaklandmarinas.com  
www.almar.com

Offer ends August 31st 2009



# Without BoatU.S., This Tow Could Cost You \$600



**VESSEL ASSIST**  
Towing You Can Trust From BoatU.S.

To join BoatU.S., Call  
**800-888-4869**  
or visit **BoatU.S.com**

*It's not that the services or your boat aren't worth it, that's just the average price of a tow on the water without towing service from BoatU.S.*

BoatU.S. offers Unlimited towing services to Saltwater/freshwater boaters for just \$135 and to Freshwater-only boaters for just \$53. You may never need to carry extra cash again. Just present your Membership card as payment.

**Unlimited Towing services include:**

- ✓ On-the-water towing, soft ungroundings, jump starts & fuel delivery
- ✓ Applies to ALL recreational boats you own, borrow or charter
- ✓ 24/7 dispatch and assistance
- ✓ No claim made on your hull insurance

**Bottom line...pay a little now or a whole lot more later.**

\*Service provided during normal boating seasons. Details and exclusions can be found online at BoatU.S.com/towing or by calling.

**LIFELINE**  
...the heart of your system™

Crafted for quality in the U.S.A.

## MARINE BATTERIES

The original AGM manufacturers for the Marine and RV Industry

**Sealed, Pressure Relief Safety Valves**  
Operates in any orientation without leaking. Maintenance-free; never requires water additions.

**Lifting Handles**  
Easier handling, carrying & installation.

**Copper Alloy Terminals**  
Provides low resistance electrical connection (copper-to-copper), non-corrosive, increased environmental protection & personal safety — no exposed lead.

**Reinforced Copolymer Polypropylene Container & Cover**  
High impact resistance and resists bulging even under severe overcharge and temperature.

**Absorbent Glass Mat (AGM) Separator**  
Custom designed and manufactured to provide superior wicking characteristics for electrolyte retention.

**Thick Plates and High Density Oxide Paste Materials**  
Insures long life, excellent cycling capability.

**Polyethylene Envelope**  
Eliminates internal shorts caused by shock, vibration & dendrite growth.

**Inter-cell Connections**  
Massive "over-the-partition" weld increases the weld strength & provides low resistance connection path.

**Cover-To-Container Seal**  
Strong, epoxied tongue & groove cover/container seal will not separate even under extreme temperature & pressure changes or vibration.

Lifeline, a pioneer in AGM technology was originally developed in 1985 by military aircraft. Lifeline series of maintenance free deep cycle batteries that has been the leading AGM battery in the Marine and Motor Coach Industry for the past 15 years.

To learn more about Lifeline Batteries contact us or visit our web site at:  
**LIFELINE BATTERIES, INC.**  
955 Todd Ave.,  
Azusa, CA 91702  
800-527-3224  
<http://www.lifelinebatteries.com>

# YANMAR INSTANT REBATE

**ALL YM & JH SERIES**

**SAVE UP TO \$300 PER ENGINE**

For details and restrictions, contact a Factory Authorized Yanmar Dealer near you:

**NOW SERVING THE EAST BAY AREA**

**BOATSWAIN'S LOCKER®**  
866-908-2676

2394-A Mariner Square Dr., Alameda CA  
931 W. 18th St., Costa Mesa CA  
[www.boatswainslocker.com](http://www.boatswainslocker.com)

2 locations to serve you

# ANDERSON'S BOAT YARD

Where do you go for the final touch-ups on your 85-ft custom power yacht?

**ANDERSON'S** of course!



***The #1 Boat Yard on the Bay!***

*All of us at Anderson's  
would like to thank  
all our customers  
for choosing the  
#1 boatyard  
on the Bay.*

***Call now to reserve space for:***

- Sprayed racing bottoms
- Custom topside paint jobs
- Complete rigging shop
- Custom metal fabrication
- Electrical installation & repairs
- Engine service and repower

***Come see us  
for your  
boating needs!***

**400 HARBOR DRIVE • SAUSALITO, CA 94965**

**(415) 332-5432 • (800) 310-5432**

**Fax: (415) 332-8136**

**andersonsboat@pacbell.net  
www.andersonsboatyard.net**

** Interlux**  
yachtpaint.com



# FAST IS FUN!

## SC<sup>37</sup> Santa Cruz YACHTS



**Two in Stock – Call Now**

Recent wins reveal  
**SCORCHING SPEED!**

2009 Vallejo Race:

Fastest elapsed time, **FIRST** in class

2009 Border Run, Newport to San Diego:

First to finish monohull by one hour!

In the Santa Cruz tradition – a downwind flyer.

Call for a test sail... *and hold on tight!*

Dealers for Santa Cruz Yachts in California

**SAIL**  
*California*

Alameda  
(510) 523-8600  
info@sailcal.com



Newport Beach  
(949) 675-8035  
San Diego  
(619) 224-6200  
jeff@jk3yachts.com

www.jk3yachts.com • www.sailcal.com  
www.santacruzayachts.com

## CALENDAR

### Non-Race

**July 30-Aug. 2** — H&S Power & Sailboat Owner Rendezvous at Catalina Island. Register at [www.hsyacht.com](http://www.hsyacht.com).

**Aug. 1** — Flea Market & Maritime Celebration at Galilee Harbor in Sausalito, 8 a.m.-6 p.m. Info, (415) 332-8554 or [www.galileeharbor.org](http://www.galileeharbor.org).

**Aug. 1, 6, 8, 13, 15, 20, 27** — Sail aboard SF Maritime National Historic Park's scow schooner *Alma*. Learn the Bay's history on this 3-hour voyage, leaving Hyde St. Pier at 1 p.m. \$35 adult, \$20 kids 6 & up. Info, [www.nps.gov/safr](http://www.nps.gov/safr).

**Aug. 2-30** — Free sailing at Pier 40 every Sunday courtesy of BAADS. Info, (415) 281-0212 or [www.baads.org](http://www.baads.org).

**Aug. 5** — Howl at the full moon on a Wednesday night.

**Aug. 5-26** — Wednesday Yachting Luncheon Series at St. Francis YC, 12-2 p.m., \$13.50. Enjoy lunch and a dynamic speaker every Wednesday. All YCs' members welcome. More info under the 'Events' tab at [www.stfyc.com](http://www.stfyc.com).

**Aug. 6-9** — Beneteau Owners Rendezvous at Catalina's Two Harbors. Info, [www.southwesternyachts.com](http://www.southwesternyachts.com).

**Aug. 11-Nov. 3** — Sailing Skills and Seamanship course by USCG Auxiliary at Sausalito Cruising Club on Tuesdays, 7:30 p.m. \$75 fee includes textbook. Contact Margrit at (415) 324-3739 or [margritkeyes@sbcglobel.net](mailto:margritkeyes@sbcglobel.net) to register.

**Aug. 13** — Single sailors of all skill levels are invited to the Single Sailors Association monthly meeting at Ballena Bay YC, 6:30 p.m. Info, [www.singlesailors.org](http://www.singlesailors.org) or (510) 233-1064.

**Aug. 15** — Alameda YC Membership Drive and Open House at Fortman Marina in Alameda, 11 a.m.-5 p.m. Complimentary lunch! Info, (510) 522-9080 or [www.fortman.com](http://www.fortman.com).

**Aug. 15-16** — A Century of Guarding the Golden Gate event at Angel Island, free. Info, [www.angelisland.org](http://www.angelisland.org).

**Aug. 16, 30** — Cal Sailing Club's free introductory sails at Berkeley Marina, 1-4 p.m. Info, [www.cal-sailing.org](http://www.cal-sailing.org).

**Aug. 21-23** — 22nd Annual Metal Boat Festival in Port Angeles, WA. Info, [www.metalboatsociety.org](http://www.metalboatsociety.org).

**Aug. 22** — Boating Safety course by USCG Auxiliary at Aeolian YC in Alameda, 9 a.m.-5 p.m. \$25 fee, \$10 lunch. Info, (510) 523-2586 or [aeolianyc@aol.com](mailto:aeolianyc@aol.com).

**Aug. 29** — 19th Annual Vallejo YC Flea Market, starting at 8 a.m. "If it's legal, sell it!" Info, (707) 643-1254.

**Sept. 7** — The unofficial end of summer — Labor Day.

**Sept. 9** — *Latitude 38's* Mexico-Only Crew List Party & Baja Ha-Ha Reunion at Encinal YC, 6-9 p.m. \$7 (free for registered 2009 Ha-Ha skippers and first mates). Info, (415) 383-8200 or [www.latitude38.com/crewlist/Crew.html](http://www.latitude38.com/crewlist/Crew.html).

**Sept. 11-13** — 33rd Wooden Boat Festival in Port Townsend, WA. "The Woodstock for wooden boat lovers." Info, [www.woodenboat.org](http://www.woodenboat.org).

**Sept. 12-20** — Northern California Fall Boat Show at Jack London Square in Oakland. Info, [www.ncma.com](http://www.ncma.com).

**Sept. 16-20** — Lake Union Boats Afloat Show in Seattle. Info, [www.boatsafloatshow.com](http://www.boatsafloatshow.com).

**Sept. 15-Oct. 6** — America's Boating Class by Marin Power & Sail Squadron on Tuesdays and Thursdays, 7-9 p.m. Textbook \$50. Info, (415) 924-2712.

**Oct. 25** — Baja Ha-Ha 'Sweet Sixteen' Cruisers Rally starts from San Diego!

### Racing

**July 29-Aug. 4** — 2009 Great Pacific Longitude Race, aka 'The LongPac', a qualifier for next summer's Singlehanded TransPac. Info, [www.sfbaysss.org](http://www.sfbaysss.org).

**July 31-Aug. 2** — Aldo Alessio Perpetual for IRC, J/120s, J/105s and any other big boat one design class that fields six boats. StFYC, [www.stfyc.com](http://www.stfyc.com).

**Aug. 1** — South Bay YRA Summer #5. Contact Richard

# SAIL *California*

## YOUR PERFORMANCE YACHT SPECIALISTS

### ALAMEDA

1070 Marina Village Pkwy #108  
Alameda, CA 94501  
**(510) 523-8500**  
FAX (510) 522-0641

### SEATTLE

**SAIL NORTHWEST**  
7001 Seaview Ave. NW #140  
Seattle, WA 98117  
**(206) 286-1004**

#### Sydney 38 2000 Howl

Awesome boat, race ready, cruising comfort.  
Asking **\$169,000**



#### Santa Cruz 52, 2000 Isis

The ultimate cruising boat with shallow draft.  
Asking **\$520,000**



**J/124, 2007, Fortuna**  
For the joy of sailing, experience the J/124.  
Asking **\$298,000**



**Custom Schumacher 39, 1996, Recidivist**  
Own a legend!  
Asking **\$149,000**



**Andrews 56, 1994, Charisma**  
Asking **\$324,900**



**J/120, 2001, OuiB5**  
One of North America's most successful Big Boat One Designs, the J/120 is the most versatile 40-footer afloat. At our sales dock. Asking **\$199,000**



**J/105, 2002, Breezy**  
Very clean, beautiful boat.  
Asking **\$117,000**



**J/105, 2000, Bald Eagle**  
Well equipped and ready to race.  
Asking **\$114,000**



**Back Cove 29, 2005, Diamond Lil**  
She's a beauty with her new blue hull.  
Asking **\$169,000**

77' Andrews, '03**	.....Reduced!	\$899,000
56' Andrews, '94, Charisma	.....Reduced!	\$324,900
52' Santa Cruz, '00, Isis	.....New Listing	\$520,000
52' Santa Cruz, '99, Renegade	.....New Listing	\$595,000
48' J/145, Hull #9, '03**	.....	\$700,000
48' Kristen Steel Offshore, '01, Trinity**	.....Reduced!	\$529,000
44' J/44, '90, Phoenix	.....	\$219,000
41' J/124, '07, Fortuna	.....Reduced!	\$298,000
41' Passport, '90, 360**	.....Reduced!	\$239,000
41' Bianca 414, '80, Avion	.....Reduced!	\$43,500
40' Advance, '85, Caribou**	.....New Listing	\$159,500
40' J/120, '01, OuiB5	.....Reduced!	\$199,000
40' J/40, '86, China Cloud	.....	\$159,000
40' Tripp, '92, Snake Oil**	.....	\$85,900
40' Catalina 400 Mk II, '07**	.....	SOLD
39' Carroll Marine CM 1200, '95**	.....New Listing	\$82,500
39' Schumacher Custom, '96, Recidivist	.....	\$149,000
38' Sydney, '00, Howl	.....Reduced!	\$169,000
38' X-Yachts 382, '99, XTC	.....Reduced!	\$179,000
37' J/37, '88, Hull #30**	.....	\$105,000

**Ericson 35 MkIII  
Symmetry**  
Own a classic boat with many upgrades!  
Asking **\$49,000**



36' Jeanneau Sun Odyssey 36.2, '97**	.....New Listing	\$89,900
36' J/109, '04, Crazy Diamond	.....Reduced!	\$169,000
36' J/36, '83**	.....	\$57,900
35' J/105, '04, Hull #617, formerly Chili Pepper**	.....	\$127,500
35' J/105, '02, Breezy	.....	\$117,000
35' J/105, '00, Hull #347, Bald Eagle	.....	\$114,000
35' J/105, '00, Hull #298, Chilaxn	.....	\$114,000
35' J/105, '99, Life Is Good**	.....	\$83,000
35' J/105, '99, Hull #255, Rodster**	.....Reduced!	\$99,500
35' J/35c, '91, Belle**	.....New Listing	\$120,000
35' J/35, '87, Storm Front**	.....New Listing	\$55,000
35' Ericson 35 MkIII, '86, Symmetry	.....	\$49,000

34' J/34, '85, The Zoo**	.....	\$29,900
34' MJM 34z, '08**	.....New Listing	\$499,000
34' MJM 34z, '05**	.....Reduced!	\$384,000
34' Classic Hans Pederson Power Yacht, '63**	.....	\$59,000
33' J/100, '06**	.....New Listing	\$125,000
33' J/100, Hull #5, '05, Reddie Freddie	.....Reduced!	\$118,000
30' J/92, '93, J Moto	.....	SOLD
30' J/30, '84**	.....	\$34,000
29' J/29, '85, Masthead**	.....	\$28,000
29' MJM 29z, '07**	.....New Listing	\$298,000
29' Back Cove, '05, Diamond Lil	.....Reduced!	\$169,900
29' Cobalt 292, '01**	.....Reduced!	\$69,000
28' Alerion Express, '06**	.....New Listing	\$110,000
27' Nor'Sea, aft cabin, '91**	.....New Listing	\$39,500
27' Antrim 27, '98, Luna	.....	\$38,000
27' Choate, '79, Allegro Con Brio**	.....	SOLD
26' J/80, '01, Lay Down Sally	.....	\$32,000
26' Maple Bay, '92**	.....New Listing	\$65,000
22' Aquapro Raider 665, '04	.....Reduced!	\$39,900

\*\* Indicates Seattle Boats

# SAIL *California*

www.sailcal.com • email: info@sailcal.com

DEALERS FOR THESE FINE YACHTS:

**SABRE**

**Santa Cruz  
YACHTS**

**J<sup>®</sup>  
Boats**



# We Still Offer More!



## Making boating easier – and more fun! is what a marina should be all about.

That's why Oyster Cove Marina rates number one with many Bay Area boaters. It's an exclusive yet reasonable facility of 219 berths, accommodating pleasurecraft in slips up to 60-ft long.

## Oyster Cove is the private Peninsula marina closest to Blue Water boating.

Want to cruise to Sausalito, lunch at Tiburon, or sail to Angel Island? How about a day's fishing outside the Gate, or a weekend at the Delta? No other private Peninsula marina is better situated or offers nicer, fresher surroundings.

- Berths 30 feet to 60 feet
- Double Finger Concrete Slips
- Telephone Available
- Five Minutes from SFO
- Heated Dressing Rooms & Showers
- Laundry Room
- Nightly Security Patrol
- Complimentary Ice
- Cable TV/High Speed Internet
- End Ties Available at \$5.95/Ft!



## OYSTER COVE MARINA

385 OYSTER POINT BOULEVARD #8A  
SOUTH SAN FRANCISCO

(650) 952-5540

## CALENDAR

at [rjgreenawald@hotmail.com](mailto:rjgreenawald@hotmail.com).

**Aug. 1-2** — Moseley Regatta. TYC, [www.tyc.org](http://www.tyc.org).

**Aug. 3-6** — Lake Tahoe Race Week for El Toros (Nationals), Lasers, FJs, FDs, Vanguard 15s, Thistles, Windmills, etc. Tahoe YC, Darren Kramer, (530) 581-4700.

**Aug. 7-9** — Summer National Senior Games on Emeryville Flats. StFYC, [www.stfyc.com](http://www.stfyc.com).

**Aug. 8** — YRA-HDA/ODCA Fall 1. RYC, [www.yra.org](http://www.yra.org).

**Aug. 8** — Round the Rock, from the South Bay to Alcatraz. BVBC, [www.bayviewboatclub.org](http://www.bayviewboatclub.org).

**Aug. 8** — Ronstan Bay Challenge. StFYC, [www.stfyc.com](http://www.stfyc.com).

**Aug. 8** — HO Lind #5 & 6. TYC, [www.tyc.org](http://www.tyc.org).

**Aug. 8** — Gracie & George Regatta, a co-ed doublehander featuring 'Gracie' on the helm. EYC, [www.encinal.org](http://www.encinal.org).

**Aug. 8** — The return of the Bay classic Midnight Moonlight Maritime Marathon, a night run from Raccoon Strait to Carquinez Strait and back. SFYC, [www.sfyc.org](http://www.sfyc.org).

**Aug. 8-9** — J/24 & Olson 25 Nationals. BYC, [www.berkeleyyc.org](http://www.berkeleyyc.org).

**Aug. 8-9** — 18th Annual Day on Monterey Bay Regatta to benefit Big Brothers-Big Sisters. SCYC, [www.scyc.org](http://www.scyc.org).

**Aug. 14-16** — Laser Masters Nationals. MPYC, [www.mpyc.org](http://www.mpyc.org).

**Aug. 15** — YRA-OYRA Half Moon Bay Race. HMBYC, [www.yra.org](http://www.yra.org).

**Aug. 15** — Tri-Island Race around Treasure Island, Alcatraz and Red Rock. RYC, [www.richmondyc.org](http://www.richmondyc.org).

**Aug. 15** — Lady and the Tramp doublehanded race on Folsom Lake. FLYC, [www.flyc.org](http://www.flyc.org).

**Aug. 15-16** — BAYS #4/Jr. Olympic Festival at SFYC. Info, [www.bayarea-youthsailing.com](http://www.bayarea-youthsailing.com).

**Aug. 15-16** — El Toro Worlds on Pinecrest Lake. Info, [www.eltoroyra.org](http://www.eltoroyra.org).

**Aug. 16-30** — 505 NAs and SAP 505 Words. StFYC, [www.stfyc.com](http://www.stfyc.com).

**Aug. 22** — SSS Richmond/South Beach Race for single- and doublehanders. SSS, [www.sfbaysss.org](http://www.sfbaysss.org).

**Aug. 22-23** — YRA-HDA/ODCA Fall 2 off the Cityfront. Info, [www.yra.org](http://www.yra.org).

**Aug. 22-23** — 2nd Annual Sarcoma Cup fundraiser. Info, [www.beatsarcoma.org](http://www.beatsarcoma.org) or [nat@beatsarcoma.org](mailto:nat@beatsarcoma.org).

**Aug. 23** — Fall Series #1 (Lidos) on Fremont's Lake Elizabeth. Info, [www.fremontsailingclub.org](http://www.fremontsailingclub.org).

**Aug. 22-30** — Mercury Nat'l's. RYC, [www.richmondyc.org](http://www.richmondyc.org).

**Aug. 29** — Great San Francisco Schooner Race, for schooners in Gaff and Marconi divisions. SFYC, [www.sfyc.org](http://www.sfyc.org).

**Aug. 29** — Joan Storer Regatta, TYC's women skippers' race. Info, [www.tyc.org](http://www.tyc.org).

**Aug. 29** — PICYA Youth/CHISPA Regatta, hosted by Encinal YC. Info, [www.picya.org](http://www.picya.org).

**Aug. 30** — YRA-HDA/ODCA Fall 3. YRA, [www.yra.org](http://www.yra.org).

**Aug. 30** — YRA-WBRA (City). YRA, [www.yra.org](http://www.yra.org).

**Aug. 31-Sept. 4** — 18-ft Skiff International, including Ronstan Bridge to Bridge, a mad dash from the Golden Gate Bridge to the Bay Bridge for 18s, boards and kites. StFYC, [www.stfyc.com](http://www.stfyc.com).

**Sept. 4** — Windjammers Race. Pop the chute and head for Santa Cruz! SCYC, [www.windjammersrace.org](http://www.windjammersrace.org).

**Sept. 5** — 21st Annual Jazz Cup, a 26-mile romp from T.I. to Benicia YC. SBYC, [www.southbeachyc.org](http://www.southbeachyc.org).

**Sept. 5** — South Bay YRA Summer #6. Contact Richard at [rjgreenawald@hotmail.com](mailto:rjgreenawald@hotmail.com).

**Sept. 5-6** — BAYS #5 at RYC. Info, [www.bayarea-youthsailing.com](http://www.bayarea-youthsailing.com).

**Sept. 10-13** — 45th Rolex Big Boat Series, the highlight



# QUANTUM PHYSICS

QUANTUM SAIL



A happy Terry Hutchinson and crew after winning the 2008 Med Cup aboard Quantum Racing.

The relationship between iQ™ technology and winning.

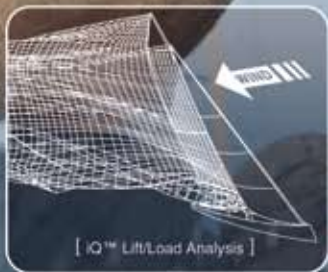

62°  
Increased  
Smileage

► The untold story behind Quantum Racing's dominating performance at the Med Cup and TP52 World Championship was a unique collaboration among sail, boat, and rig designers made possible by Quantum's new iQ™ technology ~ sail making's most advanced design system.

The insight provided by iQ's modeling and analytical capabilities helped create a mainsail that combined increased power with decreased rudder angle ~ and generated remarkable speed.

However, the best part about iQ is that it's a tool, not just for winning at the grand prix level, but for increasing the performance ~ and the enjoyment you get from sailing ~ at every level. iQ brings the ultimate in computational horsepower to the design of every sail Quantum builds.

Or to put it in scientific terms: Enjoyment².



# SAFETY TETHER



- ORC Approved Offshore Tether
- Quick Release Inboard End
- Florescent Double Action Safety Hooks

The Hot Forged Advantage



**Wichard**  
www.wichard-usa.com



## CALENDAR

of the local sailing season. StFYC, [www.stfyc.com](http://www.stfyc.com).

**Sept. 12** — YRA-OYRA Northern Star. EYC, [www.yra.org](http://www.yra.org).

**Sept. 12-13** — West Marine Fun Regatta for junior sailors. SCYC, [www.scyc.org](http://www.scyc.org).

**Sept. 14-19** — Folkboat Int'l Regatta. CYC, [www.cyc.org](http://www.cyc.org).

**Sept. 19-20** — Leukemia Cup Regatta, PHRF and one design racing to benefit the Leukemia and Lymphoma Society. Hosted by SFYC, featuring keynote speaker Al Gore. Info, [www.leukemiacup.org/SF](http://www.leukemiacup.org/SF).

### Summer Beer Can Regattas

**BALLENA BAY YC** — Friday Night Grillers: 8/7, 8/21, 9/4, 9/18, 10/2, 10/16, 10/30. Info, (510) 523-2292 or [race@bbyc.org](mailto:race@bbyc.org).

**BAY VIEW BOAT CLUB** — Monday Night Madness Fall: 8/3, 8/17, 8/31, 9/14, 9/21 (make-up). Peter McCool, (415) 864-4334 or [bayviewracing@sbcglobal.net](mailto:bayviewracing@sbcglobal.net).

**BENICIA YC** — Every Thursday night through 9/24. Mike Munn, (408) 671-1484 or [mmunn88@sbcglobal.net](mailto:mmunn88@sbcglobal.net).

**BERKELEY YC** — Every Friday night through 9/25. Bobbi Tosse, (925) 939-9885 or [bobbi\\_john@jfcbat.com](mailto:bobbi_john@jfcbat.com).

**CAL SAILING CLUB** — Year-round Sunday morning dinghy races, intraclub only, typically in Laser Bahias and JY15s. Email Gary and Alistair at [racing\\_chair@cal-sailing.org](mailto:racing_chair@cal-sailing.org).

**CORINTHIAN YC** — Every Friday night through 9/4. Donal Botkin, (415) 497-5411 or [racing@cyc.org](mailto:racing@cyc.org).

**COYOTE POINT YC** — Every Wednesday night through 10/28. Torin Knorr, (650) 863-2570 or [regatta@cpyc.com](mailto:regatta@cpyc.com).

**ENCINAL YC** — Friday Night Summer Twilight Series: 8/7, 8/21, 9/11, 9/25. Matthew Dean, (510) 406-0851 or [rearcommadore@encinal.org](mailto:rearcommadore@encinal.org).

**FOLSOM LAKE YC** — Every Wednesday night through 9/16. Steve Galeria, (916) 635-3911 or [www.flyc.org](http://www.flyc.org).

**GOLDEN GATE YC** — Friday nights: 8/14, 8/28. Mont McMillen, (209) 481-5158 or [ggycrace@deck@aol.com](mailto:ggycrace@deck@aol.com).

**ISLAND YC** — Friday Island Nights: 8/14, 8/28, 9/18. Info, (510) 521-7442 or [www.iyc.org](http://www.iyc.org).

**LAKE TAHOE WINDJAMMERS YC** — Every Wednesday night through 10/14. Mike Robinson, (530) 713-9080

**LAKE WASHINGTON SC** — Every Thursday night through 8/27. Roy Pitts, (530) 908-7160, [rpitts@ucdavis.edu](mailto:rpitts@ucdavis.edu) or [www.lwsailing.org](http://www.lwsailing.org).

**MONTEREY PENINSULA YC** — Sunset Series, every Wednesday night through 9/30. Ray Ward, (831) 659-2401 or [www.mpyc.org](http://www.mpyc.org).

**OAKLAND YC** — Wednesday Night Sweet 16 Series, every Wednesday through 9/16. Sheldon Haynie, (510) 368-5427 or [sheldonhaynie@gmail.com](mailto:sheldonhaynie@gmail.com).

**RICHMOND YC** — Wednesday nights: 8/5, 8/12, 8/19, 8/26, 9/2, 9/16, 9/30. Eric Arens, [ericarens@comcast.net](mailto:ericarens@comcast.net) or (510) 841-6022.

**ST. FRANCIS YC** — Wednesday Night Series: 8/5-8/26. Thursday Night Kiting Series through September. Friday Night Windsurfing Series through September. John Craig, (415) 563-6363 or [racingmgr@stfyc.com](mailto:racingmgr@stfyc.com).

**SANTA CRUZ YC** — Wet Wednesdays, every Wednesday night during Daylight Saving Time. Larry Weaver, (831) 423-8111 or [lweaver@cruzio.com](mailto:lweaver@cruzio.com).

**SAUSALITO YC** — Tuesday Night Summer Sunset Series: 8/11, 8/25, 9/8, 9/22. John Mount, (415) 509-8381 or [race@syconline.org](mailto:race@syconline.org).

**SEQUOIA YC** — Every Wednesday night through 10/7. Rich Butts, (650) 576-3990 or [rbutts@pacbell.net](mailto:rbutts@pacbell.net).

**SOUTH BEACH YC** — Friday Night Series: 8/7, 8/21, 8/28. Nancy DeMauro, (415) 409-1071 or [rearcommadore@](mailto:rearcommadore@)



NOW IN  
SAUSALITO

Hanse 

and

 Moody®







THE NEW  
**HANSE 400**

400\* 

320 350 370\* 430\* 470\* 540e 630e

\*epoxy option

Compare our pricing  
against the competition

-  Ground breaking interior design
-  Multiple layout options (Individual Cabin Concept)
-  Modern, award winning performance cruisers
-  Self-tacking jib engineered into the HanseYachts design
-  Epoxy hulls (option up to 54 ft)
-  Safe, comfortable, fast & easy to sail

**Hanse Yachts US**

**New office:**

Larry Mayne Yacht & Ship Brokerage  
310 Harbor Dr., Sausalito, CA  
(near West Marine)

[www.HanseNorCal.com](http://www.HanseNorCal.com)

Larry Mayne | 650-888-2324

George Higbie | 415-672-4123

John Saul | 415-332-6585

[hansemayne@aol.com](mailto:hansemayne@aol.com)

Larry Mayne Yacht & Ship Brokerage proudly announces our new sales office for Hanse, Moody and quality pre-owned vessels in Sausalito. Step up to the Hanse or Moody lines.



# Sailrite

## Ultrafeed LSZ-1 Sewing Machine



"We've made an anchor riding sail from your kit and repaired a sail cover. We get a lot accomplished with our machine. Thanks!"

*Barbara Melson*

Call for a **FREE** Catalog



[www.sailrite.com](http://www.sailrite.com)

800.348.2769 • 260.693.2242

# CALENDAR

*sbyc.org.*

**STOCKTON SC** — Every Wednesday night through 8/26. Phil Hendrix, (209) 476-1381 or *phil.hendrix@excite.com*.

**TAHOE YC** — Wednesday Night Summer Keelboat Series through 8/26. Fall Series: 9/2-9/23. Monday Night Summer Laser Series through 8/24. Darren Kramer, (530) 581-4700 or *www.tahoeyc.com*.

**TIBURON YC** — Every Friday night through 8/11. Gary Proctor, (415) 827-2622 or *www.tyc.org*.

**VALLEJO YC** — Every Wednesday night through 9/30. Gordon Smith, (530) 622-8761 or *fleetcaptainsail@vyc.org*.

Please send your calendar items by the 10th of the month to *calendar@latitude38.com*. If you're totally old-school, mail them to *Latitude 38* (Attn: Calendar), 15 Locust Avenue, Mill Valley, CA, 94941 or fax them to us at (415) 383-5816. But please, no phone-ins! Calendar listings are for marine-related events that either are free or don't cost much to attend. The Calendar is not meant to support commercial enterprises.

### August Weekend Tides

date/day	time/ht.	time/ht.	time/ht.	time/ht.
	LOW	HIGH	LOW	HIGH
8/01Sat	0335/0.1	1058/4.4	1502/3.2	2103/6.0
8/02Sun	0420/-0.1	1139/4.6	1554/3.1	2150/6.0
	HIGH	LOW	HIGH	LOW
8/08Sat	0106/5.6	0726/0.3	1420/5.2	1944/2.1
8/09Sun	0147/5.2	0755/0.7	1446/5.4	2027/1.9
	LOW	HIGH	LOW	HIGH
8/15Sat	0139/0.2	0918/4.0	1257/3.3	1921/6.3
8/16Sun	0242/-0.2	1014/4.4	1412/3.2	2026/6.6
	HIGH	LOW	HIGH	LOW
8/22Sat	0109/6.2	0714/0.1	1359/6.1	1944/0.9
8/23Sun	0204/5.7	0754/0.7	1436/6.2	2038/0.7
	LOW	HIGH	LOW	HIGH
8/29Sat	0205/0.6	0940/4.4	1354/3.3	1941/5.6
8/30Sun	0301/0.4	1024/4.6	1453/3.1	2040/5.6

### August Weekend Currents

date/day	slack	max	slack	max
8/01Sat	0140/3.7E	0545	0902/3.0F	
	1209	1507/1.3E	1727	2022/1.9F
	2255			
8/02Sun		0236/3.9E	0633	0949/3.2F
	1255	1547/1.5E	1816	2110/2.2F
	2344			
8/08Sat		0013/2.8F	0306	0612/4.2E
	0950	1247/3.4F	1602	1839/3.2E
	2202			
8/09Sun		0052/2.7F	0346	0650/3.9E
	1015	1318/3.2F	1628	1917/3.5E
	2243			
8/15Sat	0354	0657/2.6F	1027	1218/1.3E
	1511	1821/2.0F	2107	
8/16Sun		0043/4.3E	0459	0809/3.1F
	1131	1329/1.5E	1633	1930/2.3F
	2217			
8/22Sat		0005/4.0F	0306	0602/4.8E
	0938	1234/4.1F	1539	1827/4.4E
	2201			
8/23Sun		0055/3.9F	0401	0647/4.1E
	1018	1313/3.7F	1615	1911/4.4E
	2253			
8/29Sat	0415	0736/2.5F	1039	1334/1.0E
	1605	1855/1.6F	2129	
8/30Sun		0101/3.3E	0513	0831/2.7F
	1133	1437/1.3E	1704	1958/1.8F
	2229			

# FIRST STOP – MARINA VILLAGE



*Caliber 40*



*Hunter 50 CC*



*Catalina 445*



*Santa Cruz 37*



*J/122*



*Island Packet Estero*



*Jeanneau 30i*



*Ranger Tugs*

**OPEN BOAT WEEKEND  
AUGUST 8-9**



*Sabre Spirit*



*Beneteau 46*



*Alerion Express 28*

*If you're dreaming of a new boat, the first and only stop you need is at Marina Village.  
We have more sailboat dealers, brokers and boats in one location than anyone.  
Come visit.*

**Cruising Yachts**  
*Hunter · Jeanneau  
Caliber · Navigator  
(510) 749-9001*

**Farallone Yachts**  
*Catalina  
(510) 523-6730*

**Passage Yachts**  
*Beneteau · Island Packet  
Wauquiez · Alerion  
(510) 864-3000*

**Sail California**  
*J-Boats · Sabre  
Santa Cruz Yachts  
(510) 523-6730*

**BROKERS**  
*McGrath Yachts  
(510) 521-5020  
Orange Coast Yachts  
(510) 523-2628  
Richard Boland  
Yacht Sales  
(510) 521-6213*

- **Better Brokers**
- **Better Boats**
- **Better Service**

**MARINA VILLAGE**

*Much More than Just a Marina*

[www.marinavillageharbor.com](http://www.marinavillageharbor.com)

**(510) 521-0905**





# AIS Made Easy!

Latest, most cost-effective collision-avoidance solution

AIS (Automatic Identification System) receivers enable AIS-capable chart plotters and navigation software to see other vessels. AIS transponders allow other vessels to see you.

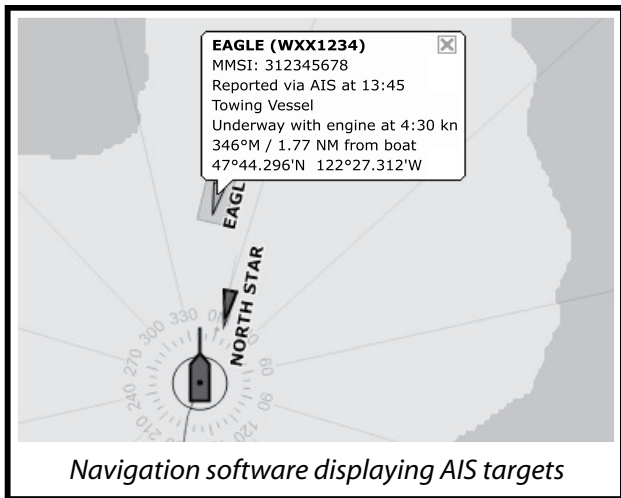

Navigation software displaying AIS targets

Milltech Marine offers complete, low-cost AIS solutions. Visit our web site for information on:

- AIS Receivers - featuring the Comar AIS-MULTI
- AIS Transponders - including Class B AIS
- Navigation Software
- Antennas, cables and other accessories



Order any product online and use coupon code "LAT38" to get free shipping in the U.S.

For more information contact:



(866) 606-6143  
www.MilltechMarine.com

## LETTERS

### NO TWINKIE DEFENSE HERE

I've been reading about the problem of unattended boats being anchored for long periods of time at Clipper Cove, and the problems they cause. I haven't read about any solutions, but I have one — based on my experience.

While anchored in a rather remote cove on the Bay, I was boarded by the Coast Guard for not having an anchor light. It's true, the cove was not a Special Anchorage, so I was required to show a light. It's also true that I hadn't displayed the required anchor ball during the day. Anyway, the Coast Guard searched my boat and I turned on my anchor light.

Little did I know that 13 months later I would receive a 13-page citation from Homeland Security. It started with saying that I was going to be fined \$6,500. It eventually was reduced to a \$100 fine and a warning. Yes, I know I had been wrong, and yes, I now always display either the ball or light as appropriate.

Clipper Cove is not classed as a Special Anchorage, which means that the anchoring balls are required during the day and anchor lights are required at night. Why isn't the Coast Guard doing its job enforcing the law there?

Hugo Landecker  
Alexander, Westsail 32  
San Rafael

Hugo — It's been our experience that there is a separate and unequal application of the laws on the waters of San Francisco Bay. If you've got a decent boat capable of navigation, all the laws apply to you. But if you've got a derelict that couldn't pass any navigation or environmental inspections, you're a sacred cow. We've seen the Marin County Sheriff and Coast Guard repeatedly engage in this kind of discrimination. We've asked both agencies to explain this odd behavior, but have got nothing but shuck and jive for our efforts. Of course, what is more American these days than rewarding bad behavior and punishing good behavior?

As for Homeland Security, we're naturally sympathetic to the concept, but honestly, what a farce! If anyone thinks Homeland Security can keep terrorists with backpack nukes out of the U.S., they've never cleared a boat back into the States

from Mexico. Despite all the money thrown at the notion of border security, the border is as porous as Swiss cheese.

We've often said that if taxpayers ever really knew how wildly the government wasted their money, there would be a revolution tomorrow instead of five to 10 years from now. That Homeland Security took over a



Sadly, our modern version doesn't seem to be any more effective than the original.

year to write a 13-page citation threatening you with a \$6,500 fine for your minor violation is just another perfect example of why such a revolution of the common man seems inevitable to us.

As for you, Hugo, we want to salute you for what is fast becoming the rarest of people in this country — somebody who admits that they did something wrong. You didn't blame it on society, a poor upbringing, drugs, alcohol or having eaten too many Twinkies. How refreshing.

# 316 Years of Crew Experience – and Counting.

**PAINT & FINISH**  
**TOPSIDE PAINTER**  
 Dave Shaw  
 24 years at Svendsen's

**PAINT & FINISH**  
**TOPSIDE PAINTER**  
 Chuck Wiltens  
 20 years at Svendsen's

**WOODWORKING**  
**WOODWORKER**  
 Dave Wilson  
 11 years at Svendsen's

**WOODWORKING**  
**WOODWORKER**  
 John Phillips  
 24 years at Svendsen's

**MECHANIC**  
**ENGINES**  
 Scott Koehler  
 2 years at Svendsen's

**MECHANIC**  
**ENGINES**  
 Stephen Enfield  
 1 year at Svendsen's

**MECHANIC**  
**ENGINES**  
 Rodney Baker  
 3 years at Svendsen's

**RIGGING SHOP**  
**RIG SHOP MANAGER**  
 Barrett Linn  
 2 years at Svendsen's

**RIGGING SHOP**  
**RIGGER**  
 Chris Tibbe  
 6 years at Svendsen's

**RIGGING SHOP**  
**RIGGER**  
 Brad Clerk  
 3 years at Svendsen's

**RIGGING SHOP**  
**RIGGER**  
 Kalin Georgiev  
 10 months at Svendsen's

**HAULOUT/LAUNCH**  
**TRAVELIFT**  
 Tim Grande  
 32 years at Svendsen's

**HAULOUT/LAUNCH**  
**TRAVELIFT**  
 Juan Zavala  
 13 years at Svendsen's

**YARD OFFICE**  
**MANAGER**  
 Ray Ronquillo  
 25 years at Svendsen's

**YARD OFFICE**  
**FOREMAN**  
 Adam Sadeq  
 4 years at Svendsen's

**BOAT YARD**  
**UNDERWATER GEAR**  
 Baudelio Solis  
 10 years at Svendsen's

**BOAT YARD**  
**EVERYTHING**  
 Adolfo Nuño  
 21 years at Svendsen's

**METAL SHOP**  
**SHOP MANAGER**  
 Chris Evanoff  
 18 years at Svendsen's

**METAL SHOP**  
**FABRICATOR**  
 Rodrigo Elias  
 11 years at Svendsen's

**METAL SHOP**  
**FABRICATOR**  
 Juan Coloriano  
 8 years at Svendsen's

**METAL SHOP**  
**FABRICATOR**  
 Jair Martinez  
 9 years at Svendsen's

**METAL SHOP**  
**POLISHER**  
 Chris Rode-Nieters  
 3 years at Svendsen's

**FIBERGLASS**  
**FIBERGLASS**  
 Bill Feucht  
 30 years at Svendsen's

**FIBERGLASS**  
**FIBERGLASS**  
 Juan Vasquez  
 12 years at Svendsen's

**BOTTOMS**  
**BOTTOM PAINTER**  
 Rosalio Contreras  
 7 years at Svendsen's

**BOTTOMS**  
**BOTTOM PAINTER**  
 Miguel Vasquez  
 3 years at Svendsen's

**FIBERGLASS**  
**FIBERGLASS**  
 Leo Espinoza  
 10 years at Svendsen's

**BOTTOMS**  
**BOTTOM PAINTER**  
 Abel Vasquez  
 3 years at Svendsen's



1851 Clement Avenue in the Alameda Marina • 510.522.2886 • svendsens.com



# Cool Tool



## Tahiti 7 x 50 Marine Binoculars

What makes a pair of marine binoculars great? We think they should be easy to use and easy on your eyes. They should be comfortable and secure in your hands, and rugged enough to withstand life aboard a wet, bouncing boat. And (this is important) they shouldn't wipe out your boating budget. Our Tahiti has incredibly sharp optics, a comfortable ergonomic shape, waterproof construction, tough rubber armor and even a built-in bearing compass and rangefinding reticle. And all for less than \$300! These really are superb binoculars at a practical price. No wonder we've sold thousands of pairs!

Model 2677755 **\$299.99**

 **West Marine®**

We have 17 stores in Northern California, including our Alameda Sailing Superstore!

Log onto [westmarine.com](http://westmarine.com) or call **1-800-BOATING** to find the store nearest you.

## LETTERS

### CLIPPER COVE SHOULD NOT BE LIMITED TO A DAY

This afternoon I picked up the July *Latitude* at Svendsens, and was interested to see several letters regarding anchoring permits for Clipper Cove. In the response to one letter, the *Latitude* editor suggested the following plan: No permits would be required Friday through Monday and online permits would be required Tuesday through Thursday. You later wrote "We're in favor of limited permitting as outlined above. Ms. Saez is considering it — along with other proposals."

"Considering it?" Oh really. The July *Latitude* went to press in late June, but on May 5, San Francisco Supervisor Chris Daly brought a proposal to the Board that would limit unpermitted stays to 24 hours. And the Board passed it. I wonder why Mirian didn't mention this *fait accompli* to *Latitude*.

In response to your June article about Clipper Cove, I wrote Ms. Saez suggesting unpermitted stays of up to one week, but never received any response. The boating community needs to exert pressure on San Francisco to allow unpermitted stays of a longer duration, but I'm not sure of the best way to try to get that done.

Martin Thomas  
Kokopelli, Sabre 34  
Alameda

*Martin — According to Director of Island Operations Mirian Saez, Supervisor Daly entered the policy — to limit unpermitted stays — for consideration but she says no time limit was specified and the details of the plan were not discussed. Keep in mind that TIDA proposed requiring permits for Clipper Cove to force out squatters, not to inconvenience the boating community. "This policy is meant to be helpful," Saez insists. "If it turns out to not be helpful, we'll change it as necessary."*

*Cynics may scoff and say we're naïve to believe a government official, but having personally met and spoken at length with Saez, we can confirm her passion for making Treasure Island — including Clipper Cove — a welcoming place for everyone to visit, not just a few cheapskates who don't want to pay slip fees. To that end, she's still encouraging Bay Area boaters to contact her at [mirian.saez@sfgov.org](mailto:mirian.saez@sfgov.org) with their suggestions for exactly how the permit process should work. "We'll be taking the comments before the Board of Supervisors sometime in September," she said, "and they'll help us put together the guidelines." And don't get your knickers in a twist if you don't hear back; she says no one has. "There were far too many to respond to each personally. But keep 'em coming!"*

### JUST ANOTHER BAND OF PIRATES

I'm curious to know under what legal authority the Treasure Island Development Authority has gained jurisdiction over Clipper Cove. Has the land/water officially been taken over by the City of San Francisco? And if so, is San Francisco now responsible for its clean up?

If you'll remember, last year my anchor line was cut by someone, which sent my vessel adrift. She was later taken in by the Coast Guard. Even after having been a victim of the unsavory sorts that frequented the cove, I'm strongly against yet another anchorage's being taken over by an even more insidious band of pirates.

At least Angel Island — due to the complete mismanagement of tax dollars and utter ineptitude of government — will soon fall. I'll personally accept that in trade.

Capt. Pugnacious  
Your Vessel if You're Not Careful

*Capt. Pug — TIDA has jurisdiction because the Navy des-*



## STRATIS: DEFINING THE FUTURE

**STRATIS.** The latest in advanced sail technology.

**Lighter.** Unique pre-preg fiber and film lamination process precisely controls the amount of adhesive in each **STRATIS** sail.

**More Durable.** Precision lamination means strength and effective shape-holding across the wind range, which adds up to durability.

Join the revolution! Contact your local Doyle loft.

### **Doyle San Francisco**

Bill Colombo & Rusty Canada  
2035 Clement Avenue  
Alameda, CA 94501

510-523-9411

[sanfrancisco@doylesails.com](mailto:sanfrancisco@doylesails.com)

Authorized Dealers for



[doylesails.com](http://doylesails.com)

BETTER ENGINEERED SAILS

800-94-DOYLE



# Puff Pieces



## West IV

Here are PFDs engineered to save sailors' lives. And we're happy to note that they already have! What makes them so effective is that they provide up to 35 lb. of positive buoyancy (like the bulkiest foam lifejackets), but they're compact and comfortable to wear. Which means that you're more likely to be wearing them when you need them.

We offer models with or without a built-in safety harness, and three different inflator styles. But no matter which model you choose, these are PFDs you can count on in an emergency. And that's not just "puffery."

**\$199.99 to \$299.99**

 **West Marine®**

We have 17 stores in Northern California, including our Alameda Sailing Superstore!

Log onto [westmarine.com](http://westmarine.com) or call **1-800-BOATING** to find the store nearest you.

## LETTERS

ignated the organization as official caretaker of the property until the transfer to the City of San Francisco is complete. "We hope that will happen within 12-15 months," Saez noted.

In heavily populated areas, such as most of coastal California, we think it's necessary for anchorages to be managed by some kind of authority. Where that's not the case, the anchorages tend to be expropriated by the few — often a lawless few — at the expense of everyone else. Hopefully, Clipper Cove will be lightly managed by a small and efficient government agency or private company for the maximum enjoyment of all.

### ↑↓ ANDERTON COULD STILL HAVE A CLAIM

I hope you'll forward the following information to John Anderton, as it may help him recoup some of his loss as a result of his Cabo Rico 38 *Sanderling's* being rammed by an unlit steel motor vessel off Eleuthera. I'd like to see him continue cruising, and I hope to meet him in an anchorage some day.

It seems that insurance companies — there are some exceptions — often assert reasons to deny a claim even if the grounds for the denial might not hold water legally. Anderton apparently assumed that his insurer would deny his claim because his boat was not being "properly crewed" due to the fact that he was singlehanded. However, he was awake and on deck, and he says he waved a flashlight at the oncoming 'destroyer' to alert its crew to his presence. Therefore, the lack of other people on board did not contribute to the cause of the collision. It appears that Anderton did a great job of controlling the damage.

In jurisdictions with which I'm familiar, the lack of a connection between the exclusion or asserted reason for the denial and the cause of the loss often negates the application of the exclusion or asserted basis for the denial. If Anderton's insurer denies his claim, I hope he challenges the denial. The insurer, of course, just hopes that he'll get discouraged and forget it.

If, in fact, the law is favorable to his claim and the insurer stonewalls him and refuses to listen to reason, then he may have a bad faith claim against the insurer. Bad faith claims are how we motivate insurers not to try to cheat us.

Ed LaBarre  
Currently Tucson, soon to be Sausalito

*Ed — A lot would depend, of course, on where John's insurance company is based. There are lots of not-very-consumer-friendly insurance companies and countries in the Caribbean. Nonetheless, we think you offer excellent advice — if the cause of a loss has nothing to do with a particular exclusion, a boatowner should not simply assume that the claim can be denied.*

### ↑↓ ROCKIN' & ROLLIN' IN THE ESTUARY

I have 30 years of sailing experience, but I'm new to the Oakland Estuary. I'd like to know something about allowable tug speeds and if the tugs are responsible for their wakes.

At 3:45 p.m. on June 19, the tug Z3 came into the Estuary from the northwest. I estimate that it was travelling between 12 and 14 knots, which created a substantial wake for us and our Columbia 28 to deal with.

The next morning we were sailing out the Estuary when I spotted a wall of white water that spanned the width of the Estuary inside of Buoy 8. The cause of it was the tug Z3, which I estimate to have been doing 15 to 19 knots. I started my Atomic 4 engine so we could take what I guessed to be a wave of six feet at a 45° angle, and braced for the E-ticket ride over it. Even though we were 20 yards from a docked container ship, I feared that the tug's wake would pin us against it. As



# MODERN SAILING SCHOOL & CLUB

Sausalito, CA [www.ModernSailing.com](http://www.ModernSailing.com) 800-995-1668

**Have you been thinking about sailing?**

the Second Annual

# Sail Fest

**Saturday, October 3rd**

**1 - 5pm**

at Modern Sailing School & Club in Sausalito



- ▲ **Free Sailboat Rides (11am - 5pm)**
- ▲ **LIVE Music and Food**
- ▲ **Local Vendors**
- ▲ **Boat Show**

**Everybody is welcome - Attendance is FREE!**

Call 415-331-8250 for more information.

## Advanced Certifications in Exotic Locations

### Belize Flotilla

**Nov. 29 - Dec. 9, 2009**

Our flotillas are an opportunity for you to practice your sailing skills in exotic waters with the support and social camaraderie of a group. Join John Connolly on his boat and get your Cruising Catamaran Certification (ASA 114).

\$2195 / berth  
\$3950 / cabin



Head Instructor  
John Connolly

### South Pacific

\$2700 / berth  
\$4995 / cabin



**Get OPM (ASA 108) certified on LEG 1.**

If you are looking for offshore experience, Leg 1 will deliver, as there is a 200 mile passage between Raiatea and the Tuomotus, which is home to the second largest atoll in the world: Rangiroa. Call us for details - see you there!

LEG 1: April 23 - May 1, 2010  
LEG 2: May 6 - 16, 2010  
LEG 3: May 20 - 30, 2010

**Leg 2 and 3  
SOLD OUT!**

## Get Your Captain's License



**Nov. 7 - Dec. 6**  
Work Friendly Schedule

**OUPV LICENSE - \$995**  
**100 TON LICENSE - \$1195**

Save yourself months of preparation time by letting Modern Sailing School & Club lead you through the Coast Guard licensing process. Our **GUARANTEED**, U.S. Coast Guard Approved course will prepare you for all elements of the exam, guide you through the application process, and conclude with on-site testing.

**Feb. 15 - 27, 2010**  
2 week intensive



## PREPARE TO TAKE THE HELM



# Functional Gear, Fantastic Value!



## Third Reef Foul Weather Gear

A perennial best-seller, our 5th generation Third Reef Foul Weather Gear is now better than ever. It's totally waterproof, breathable, built to last and packed with the kind of comfort features you'd expect to find only on much more expensive gear. Jackets and Bibs (Women's Drop Seat) in Men's and Women's sizes. For bashing around the Bay, or cruising along the coast, you won't find better gear at a better price. Available at all West Marine stores or online at [westmarine.com](http://westmarine.com).

Jackets **\$119.00**  
Bib Pants **\$99.00**

 **West Marine®**

We have 17 stores in Northern California, including our Alameda Sailing Superstore!

Log onto [westmarine.com](http://westmarine.com) or call **1-800-BOATING** to find the store nearest you.

## LETTERS

it turned out, the captain of the Z3 never slowed and the bow of my boat pitched 45° in the air.

After we made it over, I could hear the wake from the other side of the tug hitting the concrete seawall on the other side of the Estuary. It sounded like an endless series of shotgun blasts. We also watched an F-31 trimaran come clean out of the water going over the tug's wake, and were very concerned for an older woman who was kayaking.

What's the rule?

Chuck Kruskamp  
Harvest, Columbia 28  
Marina Village

Chuck — It's not as clear cut as you might hope, but creating an excessive wake for the conditions — i.e. when there are small boats in the area — could be considered the negligent operation of a vessel under the Inland Rules of the Road. For example,



**Wake up! If your wake causes damage to another boat or its crew, you might be liable for damages.**

in June of '05, a guy and his cousin were fishing in a 14-ft boat on the Cumberland River when a tug towing a barge full of coal passed by. The fishing boat was swamped and one man drowned. The wife of the dead man sued the Tennessee Valley Authority (TVA) and a district

court awarded her \$3.3 million. The award was knocked down to \$420,000 in the Sixth Circuit Court for technical reasons.

Fearing such lawsuits, most captains and tug companies try to be careful. A number of years ago there were several complaints about the way one captain drove his tug on the Estuary. The guy would flip the bird to anyone who complained about his wake. When the owner of the tug company found out, he apologized profusely in person and in print, and promised to discipline the captain.

As you may know, all ship movements in and around San Francisco Bay are closely tracked by Vessel Traffic Service (VTS) and AIS. No tug or other sizeable vessel can make a move without its identity, speed, heading and other information being broadcast to VTS and other mariners. So if you've got a serious problem with a tug wake, immediately get on the radio with the Coast Guard, which can contact VTS to see how fast the tug is going and if the wake is likely to be dangerous.

On the other hand, it's the responsibility of all who go out on the water to handle themselves and their boats with a reasonable amount of skill. We used to sail small boats in and out of the Estuary, and quickly learned how to handle even the biggest wakes. In fact, we secretly craved the biggest wakes, as they were best for little surfs when we were sailing home in the prevailing following winds.

### WE'RE A LAUGHING STOCK

I'm writing with regard to John and Gilly Foy's Kong anchor swivel breaking, as reported in the May issue. I'm glad the Foys didn't lose their boat, but I think the failure of the Kong was due to an installation error rather than a defect in the swivel itself. I hope that my letter can help other sailors avoid a similar experience.

The reason I'm saying it was an installation error is that the most highly stressed part of an anchor swivel is the pin

# Radio Check!



**M**Meet Howard Keiper, Certified Marine Electronics Technician at Berkeley Marine Center. With his sophisticated instruments, Howard can test your radios and antennas to ensure optimal output – something not always evident when doing an on-the-air check. Howard's long list of certifications make him one of the top technicians in the region.

**Ask us for your  
FREE RADIO CHECK WITH YOUR NEXT HAULOUT!**



## Lift capacity 35 tons

Sprayed Racing Bottoms  
Full Painting Service  
Fiberglass & Gelcoat Repairs  
Rigging Repairs & Installation  
Electrical Repairs & Installation  
Engine Service & Repowering  
Propeller Installation & Tuning  
Wood Hull Repairs & Caulking  
Teak & Non-Skid Deck Repairs

**Butler  
Rigging**

Now at Berkeley  
Marine Center

**Chandlery &  
Fuel Dock  
Open 7 Days**

Mon – Fri  
8 am to 5 pm  
Sat & Sun  
9 am to 5 pm



**BERKELEY  
MARINE CENTER**

**PETTIT**  
marine paint

**Sea Hawk**  
PREMIUM YACHT FINISHES

**In Berkeley Marina • 510-843-8195 • [www.berkeleymarine.com](http://www.berkeleymarine.com)**



# Artistic Forgeries



## Forged Shackles

When it comes to shackles, you shouldn't just accept a forgery, you should insist on it! Shackles have a tough job to do (usually holding expensive bits of your boat together), so it makes sense to buy the toughest, strongest, most reliable shackles made. Those would be the brilliant forgeries by Wichard.

These extraordinary shackles are created by drop forging 17.4 PH stainless steel, then painstakingly polishing them to a brilliant finish that defies the crevice corrosion which can cause lesser shackles to fail with catastrophic consequences.

If you want to skimp on something, go buy a forged painting. But don't skimp on something as important as a shackle. Insist on forged shackles by Wichard.



We have 17 stores in Northern California, including our Alameda Sailing Superstore!

Log onto [westmarine.com](http://westmarine.com) or call 1-800-BOATING to find the store nearest you.

## LETTERS

between the two halves of the swivel. That pin will generally be designed to take a straight line pull. But if the swivel is connected directly to the anchor, as the Foy's was, and



DON DURANT

**If you have a shackle, what's the point of the swivel?**

the wind then shifts or for some other reason the direction of pull changes, unless the anchor rolls and resets, the swivel pin will be subjected to a bending load that could easily cause it to snap. This is because the swivel can only hinge in a vertical plane when it is attached directly to the anchor. The correct way to set up an anchor swivel is to put a bow shackle on the anchor and then connect the swivel to the shackle. The shackle acts like a toggle to allow the swivel to orient itself in any direction so that the swivel pin is always subjected to a straight line pull.

If you don't think that the anchor attachment would be subjected to major side loads, then take a look at my second photo. This anchor came back from a boat that was anchored at Drake's Bay a couple of months ago. If the side loading on this anchor was big enough to bend its shank like that, think what it would have done to a little swivel pin that had only a small fraction of the cross sectional area of the anchor shank. This can happen to any anchor, but lightweight fluke type anchors like the one in the photo are especially prone to digging in and not moving when the direction of pull changes.

Setting up one's ground tackle correctly is some of the cheapest insurance that a cruiser can buy. When you think of what's at stake, it's silly to skimp to save a few bucks on a shackle. This is one place where the 'weakest link' isn't just a metaphor, it's literal.

P.S. I just came back from the Summer Sailstice event on Treasure Island. *Latitude's* John Arndt did a terrific job of organizing this event, and I think that he deserves big kudos for all that he is doing for the sailing community!

Jim Hancock  
School Director & General Manager, Club Nautique  
Alameda

Marine Engineer / USCG 50 Ton Master  
US SAILING Instructor & Instructor Trainer

*Jim — We understand what you're saying, but for a couple of reasons we don't completely agree with you. If you need*



DON DURANT

**If a bad load can bend a shank, think what it could do to a swivel pin.**

*to put a bow shackle between the anchor and the swivel for a "correct installation," why waste your money on the swivel? Looking at the first photo with your letter, it's a very nice set up, but what exactly does the swivel — which readers should know isn't a Kong brand — bring to the party? In addition, some other brand swivels — such as the Ultra Swivel by Quickline — can rotate up to 30 degrees in all directions,*

# The New Paradise Cay

**Come Join Us**  
[www.j22sf.com](http://www.j22sf.com)

**J  
22 Fleet**



One Day Regattas • Match Racing • Team Racing • Junior Sailing • BBQs  
Inexpensive Used Boats • Available to lend to prospective owners



[www.j22sf.com](http://www.j22sf.com) • email: [fun@j22sf.com](mailto:fun@j22sf.com)



# Huge Harken Winch Sale

Svendsen's has Harken winches at substantially reduced prices — **too low to advertise!**



While supplies last. Limited to stock on hand.



**SVENDSEN'S  
MARINE**

Located in the Alameda Marina, at 1851 Clement Avenue  
510.521.8454 | svendsensmarine.com

## LETTERS

thus all but eliminating the sideways bending loads that put exceptional stress on the Kong design. Finally, the Kong swivel has more parts than other brands — such as the one in your photo. The more parts, the more complications, and the more opportunities for failure.

Furthermore, if the Kong design and manufacture means the swivel is weakened by side loads and therefore needs a swivel, don't you think it's Kong's responsibility to make that point very clear to potential customers?

If somebody was going to day anchor in fair weather at Clipper Cove or in the middle of Newport Harbor, and always have their eye on the boat, we think the Kong swivel — if needed at all — might be a reasonable budget purchase. But for any kind of moderate to heavy use, and certainly for anchoring overnight or when the boat isn't going to be constantly monitored, we personally would never trust the Kong design. As you say, correct ground tackle is some of the cheapest insurance that you can buy.

Speaking of correct ground tackle, we'd be curious to know what size the anchor is in your second photo, and what boat it was being used with when it bent. Based on the size of the bar code sticker, it looks rather small. When it comes to the proper size anchor for a boat, we always thought Steve Dashew gave the best advice. "When people see the size of your anchor," he said, "they ought to laugh out loud." Our primary anchor on Profligate is a Fortress FX-125. Said to be good for boats up to 150 feet, it might be a bit of overkill, and it certainly cost more than the two smaller Fortress anchors we could have used. But we don't drag much, so we think it was worth the extra money. Besides, it's provided some people with a good laugh.

### ↑↓ PROPER LOGS ARE A GREAT REFERENCE

In response to *Latitude's* wondering if anybody kept a proper ship's log anymore, I kept a detailed operating log from the day I took possession of my *Quo Vadis* until the day I moved off her 3.5 years and many miles later. If I'm not mistaken, keeping such a log is a requirement of International Maritime Law, and is the captain's responsibility. Admittedly, this requirement is seldom enforced by any agency, and usually becomes an issue only in court or with an insurance company.

My ongoing recording of dates, times, places, and personnel also served as a framework and fact-checking reference when I wrote *The Years of Living Wet*, my book about my experience aboard my boat. I'll close by repeating the cover blurb: The years pass quickly.

John Huetter, former owner  
*Quo Vadis*, Prout 37  
San Francisco

Readers — You can buy John's book directly from his website at [www.johnhuetter.net](http://www.johnhuetter.net) or Amazon.com.

### ↑↓ THAT DEPRESSION RATED A SOFTLY SPOKEN 'SHIT'

Just a quick note in response to your *Lectronic Latitude* article of June 22 on the tropical storms off Mexico. You stated that Depression 1-E had only 30 knot winds and was "no big deal." I'm not sure what preceded the depression into Mazatlan, but around 10:30 a.m. on June 19 we got hit by a bunch of wind and rain. The wind in Marina Mazatlan was reported to be somewhere between 60 and 70 knots.

Most everyone had been watching the weather and was expecting the storm to hit on Saturday, and with wind in only the 35-knot range. Most of us had put off taking down tarps and sun shades, and were planning to do it Friday afternoon — well before the anticipated arrival of the storm. I was down



La Paz, Baja California Sur, Mexico

## DISCOVER THE FINEST MARINA IN BAJA WITHIN A LUXURIOUS RESORT SETTING.



Inner Marina



CostaBaja Beach Club



Marina Village



Las Colinas

## MARINA COSTABAJA

is located only minutes from downtown La Paz and offers the closest access in Baja to the World Heritage Site islands on the Sea of Cortez. Phase II neighborhoods are currently under construction, including Las Colinas Hillside Homes alongside the golf course and the luxurious VistaMar Residences and Casitas. Both afford homeowners sweeping water views and the opportunity to live with the marina and first-class resort amenities right in their own backyard.

The safe and protected double-basin marina features 250 slips from 30 to 200 feet, ready to accommodate vessels up to 220 feet. Built-in pump out stations, as well as TV and internet access are available at each dock, along with 24-hour security and a complete suite of TBC (Total Boat Care) services from the professional, customer satisfaction-focused staff.

Enjoy the Moorings Yacht Charters and the surrounding marina village, lined with colorful shops and restaurants, offering groceries, boat rentals and charter services for diving and fishing expeditions. Take advantage of the shuttle service to and from La Paz or access the 120-room resort hotel with its swimming pool, fitness room and restaurant.

Reserve your slip for winter now at Marina CostaBaja.

- Full Ownership Luxury Homes
  - Marina CostaBaja
- Pueblo Marinero (Marina Village)
  - CostaBaja Beach Club
  - Trail System
  - Espiritu Spa\*
- Gary Player Design Golf Course\*\*

\* future amenities  
\*\* spring 2010

Homes from the \$400s to over \$1.5 Million



Contact **Gabriel Ley** (Marina Manager) | info@costabajaresort.com | 011 52 (612) 121-6225 | www.marinacostabaja.com

VISTAMAR RESIDENCES





# HOGIN SAILS

Bring your sails by  
for a free evaluation.



- ★ Full Production/Service Loft
- ★ Repairs, Recuts, Roller-Furler Conversions
- ★ Strontrack, ATN, Dutchman, Nauteek SC200
- ★ Canvas Work
- ★ Call for Expert Advice

## 510.523.4388

Providing the Bay Area with  
Quality Sails and Service  
since 1978

Hogin Sail Makers  
1801-D Clement Ave.  
Alameda, CA 94501

Mon-Fri 8:30am to 5pm  
Saturday by appointment only

sales@hoginsails.com  
service@hoginsails.com  
www.hoginsails.com

## LETTERS

below reading with a large hatch open over the saloon table when it started to rain a little. No problem, it had been raining off and on for two days, so I just closed the hatch and went back to reading. A short time later the boat really started to move around in her slip, and I could hear the Shade Tree awning banging and popping more than normal. So I went up to see what was happening.

The wind was already starting to pick water up off the surface and blow it around. I could barely see across to the next dock south of us. It was about then that Chris, my wife, got back from town, and it looked as though she had swum back instead of taking the bus. Since she was already wet and I was quickly getting that way, we decided to get the shade down and secured on deck. I had the wind instruments on, and noted that the wind was blowing 42 knots while we were doing this.

The wind began to gust even more strongly, so after checking our lines we, along with a few of the remaining cruisers on Dock 6, started checking the docklines and sun covers on other boats. We needed to secure a number of covers and remove some of the canvas that we could not secure. During this time, the rain was blowing horizontally and it was like being sprayed with water from a 2.5-inch fire hose. Many dock boxes had their lids blown off, and these were flying around along with plexiglass windshields and assorted detritus from the boats. Ray of Mazatlan Yachts was struck in the face by one of the dock box lids, and suffered a laceration across the bridge of the nose. We also noticed a very definite lull followed by a drastic wind shift — almost like what you would expect in a hurricane, only over a very short time span.

By about 1 p.m., things calmed down and the rain slowed to a sprinkle. There were reports over the VHF from around the marina of wind speeds up to 70 knots, and two boats were reported to have blown off their cradles in the Singlar yard. We also noted that it looked as if a couple of boats in their slips had lost their headsails when they unfurled and flogged to death. There were reports from the condos around the marina of windows and doors being blown out, and exterior siding and roofing tiles being blown off. The marina and areas of the city were without power for a number of hours, and there were many trees uprooted and large signs blown down throughout Mazatlan.

So while the experience was stimulating and the rain cooled things down nicely, I think that this rated a little higher than a "no big deal" on the *Latitude* Wind Scale. Maybe a "Damn" or softly spoken "Shit". Just a thought.

Mike & Chris Brown  
Antipodes, Wauquiez Centurion 47  
Marina Mazatlan

*Mike and Chris — Let us be the first to apologize for what surely must have seemed like a casual dismissing of the very strong weather you and others were hit with. But we're a little confused, because it almost seems as though we're referring to two different weather events. We say this because the official weather track doesn't show Tropical Depression I-E reaching Mazatlan until June 20th — or at least 12 hours after you report it hitting Marina Mazatlan. And the official weather report has it never exceeding 30 knots — a far cry from the much stronger stuff that you and others clearly experienced. Probably the most likely explanation is that the tracks and wind speeds provided by the weather service just aren't that accurate.*

*For the record, Tropical Depression I-E was the latest-arriving tropical weather in the Eastern Pacific zone in recorded history. Yet before it even blew itself out two days later, it was*



THE  
**LEUKEMIA  
 CUP  
 REGATTA**

*The Leukemia & Lymphoma Society*

**September 19 & 20, 2009**  
**San Francisco Yacht Club**  
**Belvedere, CA**

**Raise a sail and help fight  
 leukemia, lymphoma  
 and myeloma**

Photo courtesy of Leslie Richter

- Event Dates:** Sat., Sept. 19 - Two races for One-Design classes organized by the St. Francis Yacht Club  
 Sun., Sept. 20 - One race for One-Design and PHRF divisions and Youth Regatta organized by The San Francisco Yacht Club
- Regatta Format:** PHRF with spinnaker & non-spinnaker divisions and one design class with six divisions
- VIP Dinner:** Saturday evening with special guest, former Vice President **Al Gore**
- Register:** Sign up today at [leukemicup.org/sf](http://leukemicup.org/sf)
- Questions:** Contact Caely Cusick at 415.625.1132 or [caely.cusick@lls.org](mailto:caely.cusick@lls.org)

**LOCAL SPONSORS**



**NATIONAL SPONSORS**





# IT'S TIME TO CRUISE DOWNWIND MARINE!

To Help Prepare for Blue Water Adventure  
**WE HAVE IT ALL**

**INFO – QUALITY PRODUCTS – SERVICE**

*The West Coast's  
most  
experienced  
cruising outfitter.*

**Digital Instruments  
Watermakers - Filters  
Life Rafts - Lighting  
Battery Charging Systems  
Plumbing and Ventilation  
Anchor Systems and more!**

Watch for our cruising seminars, scheduled for October–November, that bring out veteran cruisers, authors and dealer reps to share their knowledge on self-sufficient cruising life. A variety of topics will include Boat Outfitting and Maintenance, 12-Volt Energy Use and Troubleshooting, Emergency Preparedness, Galley Prep with Cooking Tips... and more! We are here to help you safely complete all your cruising plans.

**Buddy Boat Meetings  
with Coffee & Donuts  
Every Wednesday, 10 AM**

**Tune to Cruisers' Net  
Ch. 68 WHX369  
From 8:30 AM Weekdays**



## THREE STORES TO SERVE YOU

**All with Online Convenience!**



THE CRUISER'S CHANDLERY

[www.downwindmarine.com](http://www.downwindmarine.com)  
2804 Cañon Street  
San Diego  
(619) 224-2733  
(866) 289-0242



[www.sandiegomarine.com](http://www.sandiegomarine.com)  
2636 Shelter Island Drive  
San Diego  
(619) 223-7159  
(800) 336-SDMX  
Mexico 001-800-336-7369



[www.sailingsupply.com](http://www.sailingsupply.com)  
2822 Cañon Street  
San Diego  
(619) 225-9411  
(800) 532-3831

We are a great family of marine stores with even more service, websites, and resources to meet all of your boating needs.

## LETTERS

*joined by Hurricane Andres with winds to 65 knots, and Tropical Storm Two with 35 knots. No matter if you have a boat in Mexico or the Caribbean, or are just going to be sailing in those areas with friends, here's hoping that this hurricane season will be as gentle as the last!*

### ↑↓ **BILGE WATER OR BAY WATER?**

On June 6, a friend and I had occasion to motorsail by the ship *Grand Way*, which was tied up and loading scrap steel on the Oakland side of the Estuary. We observed and photographed water pouring out around the anchors both at midday and in the late evening when we returned. I was under the impression that pumping the bilges into the Bay was never allowed. Should I contact someone? I'm sure that they were pumping water to keep the boat on an even keel during loading of the scrap steel.

Jay Bietz  
Pygmalion, Westsail 32  
Alameda Marina

*Jay — If you see a vessel illegally pumping bilge water into the Bay, you should call the Coast Guard on VHF 16, and they will either direct your call to the proper department or take the matter in their own hands. That said, we think there are two reasons to suspect that you didn't see what you thought you saw: First, the captain of the ship would have to be an idiot to risk fines and the loss of his license by pumping bilge water in an area Coast Guard vessels pass frequently. Second, if you were designing a ship, would you have the bilge pump lines exit hundreds of feet away from the bilge at the bow and way high up by the anchors? Or would you have the exits near the bilge itself?*

*We're pretty sure that you observed was Bay water being used to clean the anchors. You'll very often see ships — and recreational boats — pumping water out from various thru-hulls, but it's unlikely that any of it was bilge water. Even many recreational sailboats recycle sea water for things like cooling the engine and refrigeration systems and running the watermaker.*

### ↑↓ **INNISFREE AND I HAVE BEEN SAILING SINCE '74**

I guess my Freya 39 *Innisfree*, which I purchased in '74, qualifies for the 'Over 30 Club'. Here's an outline of our history with the boat:

Shortly after purchasing *Innisfree*, my wife and I sailed her — without an engine — from San Diego to the Big Island and eventually to the Ala Wai Yacht Harbor in Honolulu. Four years later we set sail from the Ala Wai for the South Pacific, but were crippled 400 miles out by Hurricane Fico. By the grace of God and due to the integrity of the steel hull, we



COURTESY, INNISFREE

*'Innisfree' is a rare steel Freya 39.*

would survive to enjoy many other sails. But it did take jury rigging for us to make it back to Hilo for repairs and then back to the Ala Wai. Within a week of arriving in Honolulu, I set sail with *Innisfree* in the opposite direction, specifically to

Port Townsend, WA, and what would be our new home. For another four years or so we sailed all over the Puget Sound area and up into Canadian waters.

By the summer of '82, *Innisfree* and I were craving more

# EXPAND YOUR SKILLS WITH AN OCEAN OR COASTAL PASSAGE



## OFFSHORE SAIL TRAINING ABOARD 65' ALASKA EAGLE

*Learn what it takes* to make a major cruise under sail. Along with eight other crewmembers, you'll sail in all conditions, standing watches and steering as *Alaska Eagle* sails 180 to 240 miles a day. Our emphasis is on helping you build skills in an environment of fun and great sailing. Many who sail with us are planning voyages of their own. There is no better way to prepare.

### San Juan Island - San Francisco, CA

You will maneuver around traffic, navigate in diverse conditions, and study weather on this leg. A stop (or two) down the coast provides a chance to experience landfall, sometimes with a dramatic bar crossing.

Fee: \$2495 • Aug. 20 - Sept. 1, 2009

**HURRY!  
ONE SPOT  
LEFT!**

### San Francisco - Newport Beach, CA

The thrill of sailing under the Golden Gate Bridge is just the beginning. Stops at remote and popular anchorages make this a perfect introduction to coastal passage making.

Fee: \$1495 • Sept. 4-10, 2009

The School of  
**SAILING & SEAMANSHIP**  
| Orange Coast College



To learn more: [www.occsailing.com](http://www.occsailing.com)

To request a color catalog or specific info: **949-645-9412**

Or write: *Alaska Eagle* Voyages, 1801 W. Coast Hwy,  
Newport Beach, CA 92663



# TWIN RIVERS MARINE INSURANCE

AGENCY, INC.

*"Your Boat Insurance Specialists"*

7 Marina Plaza • Antioch, CA 94509

At The Antioch Marina

## Why Twin Rivers?

- Shop Your Renewal & \$ave ~ Flexible Survey Requirements
- Liveaboards • Mexican Liability
  - Agreed Value Policies
  - Broad Navigational Areas



Get a quick quote today at:  
[www.BoatInsuranceOnly.com](http://www.BoatInsuranceOnly.com)  
(800) 259-5701

Insurance made simple, affordable and effective.

### Representing...

 Global Marine

 CHUBB  
PERSONAL  
INSURANCE

 INTERNATIONAL  
MARINE  
UNDERWRITERS

 TRAVELERS  
Insurance brought to you

 MARKEL INSURANCE COMPANY

 ace seguros

 FOREMOST  
INSURANCE GROUP

 AMERICAN  
MODERN  
INSURANCE GROUP

 ace recreational  
marine insurance

 Safeco Insurance

LLOYD'S

Years of unbeatable experience to  
match your needs to the right product.

Worldwide Coverage

West Coast □ Mexico □ East Coast

Caribbean □ Pacific □ Atlantic

## LETTERS

sunshine, so we sailed to Southern California. Oxnard ended up being our homeport for what turned out to be years of California coastal cruising and one six-month trip to Mexico. I still sail *Innisfree* in these waters, often visiting Santa Cruz and Anacapa Islands, and occasionally Catalina.

Tony Raimondo  
*Innisfree*, Freya 39  
Oxnard

*Readers — The Freya 39 is one of the most famous Australian yacht designs ever, by virtue of the fact that the original wooden version won three consecutive Sydney to Hobart Races. Jim Gannon subsequently built about 40 of them out of fiberglass in Petaluma, including Contrary to Ordinary, which was Latitude's boat in Mexico in the early '80s.*

### ↑↓ I DID THE MATH

Reading the letters from boat owners who have owned their boats for more than 30 years, I decided to do the math, and discovered that I belong in the club. I've owned my O'Day 27 *Lady Ann* for 33 years. I've made a few interior and exterior modifications over the years because of wear and tear, but she's as sound as ever.

I've enjoyed doing two Ha-Ha's on other boats, and take joy in reading each issue of *Latitude*.

Bob Bauer  
*Lady Ann*, O'Day 27  
Alameda

### ↑↓ WE'RE VERY HAPPY WITH THE 3G CARD

I'd like to share our experience with wi-fi and data cards in Mexico. We came down with the 2008 Ha-Ha — which, by the way, was way too much fun! — and cruised as far south as Manzanillo before we headed up into the Sea. Our boat is currently on the hard in San Carlos, and we are in the States visiting for a few weeks before flying to Papeete to cruise with Dietmar and Suzanne Petutschnig aboard their Las Vegas-based Lagoon 440 *Carinthia*. Yep, life is tough!

By the way, you'll remember Dietmar and Suzanne as the ones who turned you on to the Amazon Kindle. Also parenthetically, our opportunity to cruise in French Polynesia with Dietmar and Suzanne is a result of the Ha-Ha.

But to the point: During our first months in Mexico we struggled with communication issues. Patty had cell coverage in most areas with her AT&T service, but it wasn't cheap. I had

cancelled my Verizon phone because they told me they didn't have service in Mexico. I ended up buying some Telmex phone cards, which were a pretty good value.

We both have Skype, which works well, but only if you have a very good internet connection. But we found that

Get one of these with a data card and set up your own floating internet cafe.

if others were using Skype on the same wi-fi system, it would slow stuff (like getting email) down to no better than dial-up. Out of consideration for others, we rarely used Skype, which was frustrating.

It wasn't until we got to La Paz and purchased a 3G card from Telcel that many of our issues were solved. Thanks to the Telcel data card, anywhere there was a cell tower nearby we



# THE FINEST SAILS BEGIN WITH THE BEST SAILCLOTH

Our patented woven Vectran® sailcloth performs like the laminates with the durability of Dacron®, especially in roller furling applications. In fact, Vectran® is lighter, lower stretch, and retains its shape over a longer life than any sailcloth we've ever offered to cruising sailors. That's because Hood Vectran® is woven, not laminated to Mylar® film. And you can be sure that each sail we roll out is built by hand, with the same care and craftsmanship that has been the Hood hallmark for 50 years. To discuss your sailcloth needs – whether our state-of-the-art Vectran® or our soft, tight-weave Dacron® – give us a call today.

**HOOD** Sails & Service

**HOOD** New Sails

**HOOD** Sail Repairs

**HOOD** Furling Conversions

**HOOD** Pickup & Delivery



SAILMAKERS

*Outbound Yachts  
New Outbound 52  
with Hood Vektron  
Vertical Full Batten  
In-Mast Furling  
Mainsail and 135%  
Vektron Genoa*

PHOTO COURTESY  
SWIFTSURE YACHTS

**HOOD SAILMAKERS 466 Coloma Street, Sausalito, CA 94965**

**Call Robin Sodaro (800) 883-7245 (415) 332-4104 Fax (415) 332-0943 hoodsails@aol.com**

**Visit our website for Special Online Discount Pricing... [www.hoodsailmakers.com](http://www.hoodsailmakers.com)**



# LETTERS

had a great internet connection. Obviously, there isn't service in the remote islands because there aren't any cell towers, but where there were towers, the connection was strong and very fast. We could do email, browse the net, download up to 3 gigs — no movies, but then we never did that anyway — and use our Skype without worrying that we were messing up the internet connection for others.

Our 3G card cost about \$150, and the service is about \$50/month. The good news is that you can pay for it on a month-to-month basis at any Telcel office. This is wonderful for people who don't spend the whole year in Mexico.

We have been very happy with the 3G card, as it has made life much nicer. It makes it easy for us to stay in touch with the kids, grandkids and our elderly parents. It's hard to imagine what it would be like to sail away and have no communication with home for months or years on end.

Sandy Smith

Faith, Morgan Out-Island 41  
Portland, OR

## ↑↓ GREAT SIGNALS AT TWO HARBORS

I'm writing in response to your request for information from people who work from their boats about what equipment they use. I work in the IT department for *Ticketmaster.com*, and for three years now have used Verizon wireless broadband to work from my Ericson 32, berthed in San Pedro. Because my personal account is three years old, I get unlimited data on that. My work account is newer, so I'm limited to 5 GB/month. These are my only sources of internet access.

While I get good access at my berth in San Pedro, I get an even better signal at Two Harbors, Catalina. In fact, it's faster than the free wireless at the Harbor Reef restaurant. I also use a Cradlepoint (*www.cradlepoint.com*) PHS-300 personal hotspot, which accepts the Verizon USB adapter and allows me to use up to 16 USB devices at once with the service. In other words, two computers access the internet at once. A very cool feature of this device is that it can work with any service that uses a USB adapter — including most services in Mexico and Central America. And, of course, you can use any wi-fi device with it — PSP, iPod, Xbox, PS3, webcams and anything else.

I have a Mac Mini I use as TV, radio, music player and navigation computer. My iPod touch runs iNavX, which connects over the wi-fi to the Mac Mini running MacENC or GPSNavX to get a network feed of the GPS signal. It also downloads BSB charts on-the-fly over the internet from NOAA and Navtech map servers. I can play PC and Xbox360 multiplayer games over the wireless connection, but I don't have the power to run the Xbox and LCD TV when away from shorepower.

However, the Verizon service is not quite fast enough for streaming TV services such as Netflix on-demand movies. It supports lower-quality video like YouTube without a problem. I'm looking to get a wi-fi-enabled digital camera so I can upload pictures in real-time to Facebook or a photo-sharing site.

I offer the following as great reference sites:

[www.3gstore.com](http://www.3gstore.com)

[www.evdoinfo.com](http://www.evdoinfo.com)

[www.evdomaps.com](http://www.evdomaps.com)

[www.evdoforums.com](http://www.evdoforums.com)

The 3GStore sells data plans, devices and a wi-fi router as bundles. They also run the other reference sites and a forum for users.

Mike Batchelor

Valinor, Ericson 32  
Cabrillo Marina, San Pedro

**ATTENTION CRUISERS! MEXICAN LIABILITY INSURANCE ONLINE**

**MARINERS**  
GENERAL INSURANCE GROUP

Now with six offices offering you local insurance service and global insurance coverage.

**SEATTLE**  
(800) 823-2798 • (206) 281-8144  
Fax (206) 281-8036

**NO. CALIFORNIA**  
(800) 853-6504 • (650) 373-0595  
Fax (650) 548-1585  
email: boomeins@aol.com  
Lic. # 0A99058

**L.A./ORANGE COUNTY**  
(800) 992-4443 • (949) 642-5174  
Fax (949) 642-0252  
Lic. # 0D36887

**SAN DIEGO**  
(800) 639-0002  
Fax (619) 226-6410  
Lic. # 0A96346

**BRADENTON, FLORIDA**  
(800) 914-9928  
Lic. # E051940

**New!**  
**PUERTO VALLARTA**  
(949) 274-4111

*Official Sponsor*  
**2009 BAJA HA-HA**

**ASK ABOUT OUR NEW RACING SAILBOAT PROGRAM!**

**It's a Mariner's Fact:**  
*Before heading out – check the weather, check the tides, and leave a route plan behind with friends and family.*

**www.marinersins.com**



# KEY WEST RACE WEEK 2010

Presented by Nautica  
January 18 – 22, 2010



The Florida Keys  
& Key West  
... come as you are

**Fantastic Venue  
World Class Competition  
Professional Race Management**



**J**oin racingsailors from across the country and around the world for the 23rd edition of North America's premier regatta. Premiere Racing's reputation for producing world class racing in this unbeatable venue continues with top-tier national and international competition for IRC, PHRF and One-Design classes. Race dates are January 18 – 22, 2010.

*"This truly is one of the greatest regattas in the world and to me it's the perfect winter break. It has steadily evolved over the years into an extremely high-level event in all respects."*

—Terry Hutchinson, 2008 Rolex Yachtsman of the Year



For invited classes, planning details and updates visit:  
**[www.Premiere-Racing.com](http://www.Premiere-Racing.com)**

**Premiere Racing, Inc.**

67B Front Street, Marblehead, MA 01945 USA

781-639-9545 • 781-639-9171 (fax)

Email: [KWinfo@Premiere-Racing.com](mailto:KWinfo@Premiere-Racing.com)



# WHALE POINT MARINE & HARDWARE CO.

**A FAMILY OWNED & OPERATED BUSINESS FOR THREE GENERATIONS**  
**ACE Hardware**  
 MARINE PARTS & ACCESSORIES, PLUS A COMPLETE HARDWARE STORE

Go to **WhalePointMarine.com** for additional discounts!

## LELAND Strobe Light

**NOW \$19<sup>99</sup>**

Small and compact strobe light, fits in ones pocket, with 3-mile visibility, waterproof and last for 30 hours. D Cell Battery not included.



## FALCON Air Horn

**NOW \$16<sup>99</sup>**



## GILL Deckhand Gloves

**FREE** with purchase of Gill Foulweather Gear Suite



Gill — present quality in sailing gear. Sizes: S, L & X. List \$21.99 • **Whale Pt. \$19<sup>99</sup>**

## SEADOG Winch Handle



9" aluminum, locking winch handle.

**NOW \$24<sup>99</sup>**

## FORCE 10 3 Burner Propane Stove

**FORCE 10**

Model 63351 3-burner

**Whale Pt \$1199<sup>00</sup>**

Model 63251: 2-burners **Whale Pt \$1099<sup>00</sup>**



## TROJAN & CENTENNIAL Batteries

MARINE DEEP-CYCLE BATTERIES

24TM • 85amp..... **NOW \$99<sup>99</sup>**

27TM • 105amp..... **NOW \$109<sup>99</sup>**

6 Volt..... **NOW \$159<sup>99</sup>**

8D • 12 Volt..... **NOW \$169<sup>99</sup>**

Other amp sizes available.

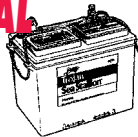

## COMPASSES Handheld



Iris 50  
List \$107.99  
**NOW \$59<sup>99</sup>**



Iris 100  
List \$199.99  
**NOW \$99<sup>99</sup>**

## FARIA Instruments



**\$24<sup>95</sup> & UP**

## LETTERS

Mike — Great report. Speaking of Two Harbors, we were all excited about getting our AT&T data card up and running out on Harbor Reef — our normal summer home — in order to work from Profligate. But while we got maximum bars for our iPhone, we got zip on our AT&T data card.

We couldn't figure it out, so we called AT&T technical assistance for help. After 15 minutes of listening to their endless ads for additional AT&T services that we'd never want, and without our ever being given any indication of when someone was going to answer our darn call, a not-very-knowledgeable person answered. When we asked her if the AT&T phone and data cards operate off the same antennas and therefore should bring us similar signals on both devices, she assured us they did and they would. After 10 more minutes of waiting, we were transferred to the laptop technical support, where the alleged expert had temporarily "forgotten" that Macs don't use the Windows operating system. That really inspired our confidence in AT&T. After another 10 minutes, we finally were transferred to someone who sounded as though he knew what he was talking about. "No, the antennas for data cards and phones are absolutely different, so in the same place your phone and data card might get a different quality signal." Wonderful. If we could have throttled the honcho at AT&T via our iPhone for his company's having wasted an hour of our time with misinformation, we surely would have.

When we went to Two Harbors a week later, we were informed that AT&T had been having problems out there. Sure enough, when we plugged our data card in, we got four bars on Harbor Reef — but still worse than dial-up service. We got the same four bars up at Emerald Bay. For what it's worth, Doña de Mallorca's Verizon gets full bars and quite good internet speed at both Two Harbors and Emerald Bay.

That said, in most places we've been — including the Harbor Reef restaurant at Two Harbors — the AT&T data card has been a little dynamo.

### TELCEL'S 3G DATA CARD ROCKS

The accompanying photo is of the Telcel 3G internet USB data card we bought in Mexico. The only bummer is that we didn't have it the entire time we were in Mexico. We bought



The Telcel 3G data card gets great reviews.

the data card in La Paz, and were able to get great internet on our boat there and as we motored out the channel. It also worked great at Muertos, off Barilles almost down to Frailes, off Cabo San Jose, Cabo San Pucas — oops, I mean Lucas — Todos Santos, Puerto Magdalena, Turtle Bay, on the inside of Cedros Island, south of San Quintin and at Isla San Martin and Ensenada. It even worked great for several days at the Police Dock in San Diego before it was shut off for roaming.

The card cost 1,400 pesos, 430 pesos for a month in advance and 350 pesos for a deposit. Supposedly, we can bring the unit back to a Telcel office to get our deposit back, but we'll probably just sell it to some southbound cruiser.

[As of the end of June, the exchange rate was 13.6 pesos to the dollar.]

Heather Stapleton Donnell  
Meerkat, Ocean 49 Catamaran  
Ventura

205 Cutting Blvd, Corner of 2nd, Richmond  
 510-233-1988 • FAX 233-1989  
 Mon-Sat: 8:30am - 5pm • Sun: 10am - 4pm • whalepoint@acehardware.com  
 Go to **WhalePointMarine.com** for additional discounts!

# COME VISIT COYOTE POINT MARINA:

*The Peninsula's Complete Recreational Destination!*



**Multihull  
side ties available  
up to 40 ft.**

## **BERTHING**

- Slips to 40' available
- 22' inside ties for \$85 per mo.
- Multihull side ties available
- Check out our rates!



## **FUEL DOCK & PUMP OUT**

- Open 7 days per week
- Gas and diesel available
- Check our prices
- Free pump outs



## **COYOTE POINT RECREATIONAL AREA – HOME TO:**

- Coyote Point Marina
- Poplar Creek Golf Course
- Coyote Point Park
- Captain's House Conference Center
- Beach, Picnic & BBQ Areas
- Coyote Point Yacht Club
- Dominic's Restaurant
- Magic Mountain Playground
- Coyote Point Museum
- Shoreline Trail

**COME FOR A VISIT – WE THINK YOU'LL STAY**

*Call us and mention this ad for a FREE One Night Guest Berth*

COYOTE POINT MARINA ~ 1900 Coyote Point Drive • San Mateo

**650.573.2594**



# MARINE EMPORIUM

At The Bridge

since 1968

## Yacht Sales



63' Chris Craft Connie, 1953  
\$180,000



40' Kayot Pontoon Houseboat, 1973  
\$16,900



30' Island Gypsy, 1982  
Fly Bridge Trawler. \$59,500



31' Flybridge Silverton, 1978  
\$12,000



27' Revelcraft, 1968  
\$4,500



21.7' Trophy, 2003  
\$22,500

- **FULL SERVICE BOAT YARD AND DRY DOCK:**  
Haulouts up to 60 tons, expert fiberglass and metal work, bottom paint, etc.
- **RUNNING GEAR and REFINISHING**
- **COMPLETE MARINE CHANDLERY**
- **PARTS and SERVICE**



5993 Bethel Island Road  
PO Box 520, Bethel Island, CA 94511  
**(925) 684-2330**  
[www.MarineEmporium.com](http://www.MarineEmporium.com)

## LETTERS

Readers — We visited Meerkat at the San Diego Police Dock before Telcel shut down their service, and saw that the Telcel data card rocked. As you'll read elsewhere this month and next, such data cards — which don't require any long service contracts in Mexico — are likely to stunt the cruiser use of wi-fi in



COURTESY MEERKAT

**Jim and Heather Donnell's Ocean 49 'Meerkat' at the Police Dock.**

Mexico. After all, who needs wi-fi if you can get reliable high speed internet access from the convenience of your boat at much greater distances than wi-fi, and at a reasonable price? Indeed, it's going to be interesting to see what effect data cards will have on cruiser SailMail/Winlink use in Mexico. These services would still be very valuable in areas where there are no cell phone towers, but where there are towers, data cards will often be no-brainers.

### ⇅ THE FILM'S AS GOOD AS THE BOOK

Have you seen *Around Cape Horn*, the 30-minute film, now on DVD, that Irving Johnson made of his 1929 voyage aboard the engineless 400-ft *Peking* sailing from Germany to Chile via Cape Horn? If you haven't, let me know, because I have an extra copy that needs a good home.

Lu Moody  
Los Alamitos Bay  
Long Beach

Lu — As we may have written in a recent issue, while in the port captain's office in St. Barth this winter, we stumbled across a copy of the small book Johnson wrote about that voyage. We weren't expecting much from *The Peking Battles Cape Horn*, but we were blown away by how well it was written, by what these brave/crazy sailors did, and how shockingly different the sailing life was back then. We can't recommend the book enough, as it's right up there with Joshua Slocum's great *Sailing Alone Around the World*. As for Johnson himself, the world is short a couple of billion people with his intelligence, bravery and character.

In the early 30s, Irving met a woman named Exy aboard Warwick Tompkins' famous pilot schooner *Wander Bird*, which was later berthed in Sausalito for many years. After getting married, Irving and his wife Exy did a total of seven wildly adventurous sail training circumnavigations with young men and women, and never had an incident. The Los Angeles Maritime Academy's twin 90-ft brigantines, which are used for non-profit youth sailing, are named the *Irving Johnson* and the *Exy Johnson* in honor of these two great sailing pioneers.

As for the *Peking*, she's on display at the South Street Seaport Museum in New York City. If you get a chance to visit her, imagine yourself standing atop her highest mast when the winds were blowing 75 knots and the seas were 30 feet. After all, that's what Johnson did — just to see if he could without falling off.

### ⇅ "I THINK THERE'S BEEN AN ERROR ON THE BILL"

Since you wrote about the costs of providing Coast Guard Search & Rescue services in the June issue, I thought you might be interested in a recent incident. After making only 150 miles in his third attempt to row from Cape Cod to France,

# Think Green,

1.

Register online for your FREE UPS shipping tag and 25% Savings Certificate, then send your old sail to the North Recycling Center.



2.

After registration, you will be issued a 25% Savings Certificate valid for purchase of a new North sail.

**25%  
SAVINGS  
CERTIFICATE**

issued upon registration and valid toward new North sail purchased by Aug. 31, 2009.

3.

Buy a new North sail by Aug. 31, 2009 and SAVE 25% OF THE PURCHASE PRICE!

\*North One-Design sails, Class Sail Development sails and North Sails Direct sails are excluded. Offer limited to boats 50 ft. LOA and smaller. Recycled sail must be received prior to shipment of the new purchased sail. Customer must take delivery of new sail prior to November 30, 2009. Other restrictions may apply.

Recycling isn't just for bottles and cans. Sails should be recycled, too, and North is going to make it worth your while to *think green and buy blue!* First, we'll pay UPS charges when you ship your old sail to the North Recycling Center. Then, we'll send you a savings certificate for 25% of the purchase price of a new North sail.\* To register for your free UPS shipping and Savings Certificate, visit [www.northsails.com](http://www.northsails.com) and click on the "Think Green, Buy Blue" icon. You'll help save the planet and save on North Sails, too!



*Better by Design*

**Sausalito** 415-339-3000

**San Rafael - Sail Care** 415-453-2142

**Channel Islands** 805-984-8100

**Marina Del Rey** 310-827-8888

**Long Beach** 562-795-5488

**Costa Mesa - Sail Care** 949-645-4660

**San Diego** 619-224-2424

[www.northsails.com](http://www.northsails.com)

# Buy Blue!

With your new North sail you'll receive a free North tote bag made from recycled sails by Sea Bags® of Maine. *Thanks for thinking green!*







**West Marine®  
Rigging Service**



# Rig Your Boat for Cruising!

**Complete Rigging Packages**

Standing Rigging • Running Rigging • Ground Tackle

**POWERLITE**  
PBO RIGGING

**ESE ROBLINE**  
WORLD CLASS YACHTING ROPES



**NEW ENGLAND ROPES**

**RONSTAN**

**SAMSON**

**Johnson**  
Marine Hardware

**HARKEN®**

**SCHAEFER  
MARINE**

**Hayn Marine**

**LEWMAR®**

**F FORESPAR®**

**facnor®**  
FURLING SYSTEMS

**Contact us for all of your Rigging Needs!**

**888-447-RIGG**

or visit our Onsite Rigging Locations in:

**Alameda, CA**

730 Buena Vista Ave.  
(510) 521-4865

**San Diego, CA**

1250 Rosecrans St.  
(619) 255-8844

**Seattle, WA**

1000 Mercer St.  
(206) 292-8663

**Annapolis, MD**

113 Hillsmere Dr.  
(410) 268-0129

**Ft. Lauderdale, FL**

2300 S. Federal Hwy.  
(954) 527-5540

**Rock Hill, SC**

860 Marine Dr.  
(803) 909-6280

## LETTERS

Frenchman Charlie Girad placed a sat phone call to the Coast Guard in Boston to report that he was "cold and didn't know what to do."

So just 10 days into his voyage, he was rescued by the U.S. Coast Guard. It reportedly cost us taxpayers \$80,000 to dispatch the Coast Guard jet and helicopter to retrieve Girad from his 21-ft custom rowboat.

Colin Dewey  
Turning Point, Ericson 29  
Encinal YC

Colin — It would be interesting to know how much of the \$80,000 were 'hard costs' already built into the Coast Guard's budget, and how much extra this rescue might have cost.

On the one hand, we think the U.S. and other countries need to provide rescue services around the world, but perhaps those who have to be rescued from extreme adventures should either have to post a bond or be presented with at least a part of the bill for their rescue. This would include entries in extreme events such as the Vendée Globe, when the margins of error for safety are so slim that in the last running only 11 of the 30 racers finished. After all, if one of these sailors needs to be rescued from the deep Southern Ocean, why should Aussie or Kiwi taxpayers have to take a big financial hit? If somebody wants to do extreme — especially if its already been done a number of times before — shouldn't he do it on his own nickel?

### PLEASE, SIR, MAY I HAVE ANOTHER?

I have an unusual request for my Nathan. After wearing his yellow Baja Ha-Ha hat non-stop for the last seven months and 7,000 nautical miles down the coast of Mexico and across the Pacific, it blew off and sank recently during a daysail on San Francisco Bay. He is more depressed about it than is normal



**Bill Vaccaro models the yellow Ha-Ha hat.**

for losing a hat. It's as though it was his badge of achievement or something. So I'm wondering, is there any chance you might have another yellow Ha-Ha hat hidden in the attic or stuck down behind a couch that we can buy?

Naomi Zell  
Hurulu, Islander 36  
Sausalito

Naomi — Unfortunately, the yellow Ha-Ha hats — new last year — went like hotcakes. The good news is that we'll have more of them by October 1, at which time you can buy another for your husband.

### WE'VE HAD TWO RIPPED OFF

We've had two inflatables stolen from our private slip at Alamitos Bay, which is a very upscale part of Long Beach. I suspect it was the work of local kids from affluent families who wanted to go joyriding.

Marty Goldsmith  
Sweet Bones, Eastbay 38  
Alamitos Bay

### MY DINGHY WAS STOLEN FROM AVALON

You asked about sailors who have gotten ripped off in California. A few years ago we had our dinghy stolen from Avalon Harbor while we were ashore. The thief took the dinghy somewhere offshore, removed the Mercury outboard, then set the dinghy adrift. It later turned up a few coves north of Avalon. I actually got more for the engine in the insurance

# SOUTH BEACH YACHT CLUB & BENICIA YACHT CLUB

*are proud to present the 21st Annual*

# JAZZ CUP

**Saturday, September 5, 2009**

*Best in Downwind Racing*

SAN FRANCISCO TO BENICIA

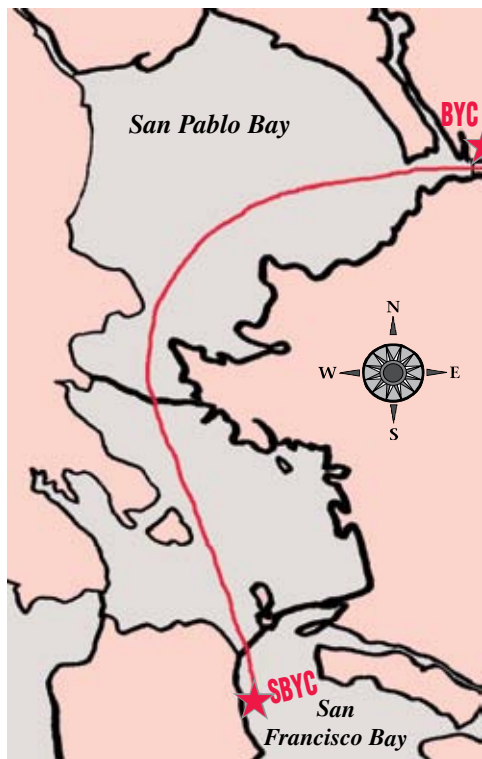

No-Host Pre-Race Dinner at  
SBYC on Friday, Sept. 4.

No-Host Post-Race Dinner and  
Party at Benicia Yacht Club,  
on Saturday, Sept. 5.

Trophies will be awarded for  
all divisions – including  
Jazz Cup Overall Winner!!

Non-Spinnaker Division  
Available

Jazz Cup Perpetual Trophy  
to be awarded between  
SBYC and BYC



Bill Erkelens' D-Class cat *Adrenaline* was First to Finish in 2008 and set a new course record!

*All Sailors Welcome!*

For Entry Forms and Sign-ups, go to [www.southbeachyachtclub.org](http://www.southbeachyachtclub.org)  
or call Roger Ladwig at **(650) 799-1445**



**One New Sail,  
One Bullet!**



The Merit 25 'Double Agent' takes a bullet.

We delivered a new sail and the results showed up instantly.

Call to upgrade your performance.



**NORTHERN CALIFORNIA**  
**(510) 523-3966**

Now in Grand Marina  
Stop by our new loft at 2021 Alaska Packer Place  
in Alameda and say hello.

Sylvain Barrielle · Synthia Petroka · Jason Crowson  
sanfrancisco@ukhalsey.com  
[www.ukhalsey.com](http://www.ukhalsey.com)

## LETTERS

settlement than I had paid for it in the first place.

Doug Thorne  
Tamara Lee Ann, Celestial 48  
San Francisco

*Readers — For the record, we know that Thorne has taken Tamara Lee Ann to Mexico at least twice.*

### ↑↓ THAT'S LIFE IN THE CITY

It's been a few years, but someone kicked in the hatchboards of my International Folkboat berthed at South Beach Harbor in San Francisco. They then apparently made themselves at home for a day or two, drank the beer in the cooler, and stole my waterproof ghetto blaster. The weird part of it is that my boat was way out at the end of one of the fingers, so whoever did it evidently passed loads of other boats to board, some quite derelict, before choosing mine. At least he had good taste in boats.

I ascribed the experience to City life. In the last 20 years, my house has been broken into twice, my office once, and my various cars more than a dozen times. In addition, I have had one car stolen twice, and eight bicycles — all of them locked at the time — stolen. Report the thefts to the San Francisco Police Department? I did make reports after the first bunch of thefts, but it soon became clear that the police weren't interested, so I stopped because it was extra aggravation.

I reckon San Francisco must have somehow been the patron saint of thieves.

Michael Connor (former owner)  
Skol, International Folkboat  
San Francisco

### ↑↓ "WOULD YOU LIKE TO GET SHOT?"

My boat was never boarded or ripped off in California, but I did have an incident in Massachusetts. I had a fixer-upper in the yard, and it was broken into multiple times, with thieves stealing six fenders and who knows what else. I finally discovered the two thieves one night about a month ago when I was sleeping aboard. The two teenagers had climbed aboard and were on their way down the companionway when I said, "Would you like to get shot?"

They must have left the boat head first, because they broke the ladder on the way down.

Gary Bickford  
Imram, Columbia 33  
Dighton, MA

### ↑↓ THE POOP ON TAKING PETS TO MEXICO

We're *Thee Amazing Grace*, entry #47 in this fall's Baja Ha-Ha, and we intend to take our two dogs. We only know that paperwork/documentation must be done within 30 days of our arrival in Mexico. We were hoping to find more specifics in the Ha-Ha literature, but there was nothing. Can you provide the essential information needed for bringing doggies into Mexico?

David Bloom  
*Thee Amazing Grace*, Vector 39  
Long Beach

*David — As a number of folks bring their dogs to Mexico each winter, you've clearly found a gap in our printed information. If you'll please excuse the terrible pun, here is the complete poop: Mexico is known to be very dog-and cat-friendly. The most you'll be asked for are a pet health certificate issued by a vet not more than 72 hours before the animal enters Mexico*

# MULTIHULLS



## PDQ 32 ALTAIR, 2000

A remarkable catamaran designed for family cruising. Bright, light and airy, the boat is fully outfitted with live-aboard convenience. You can cruise this boat in quiet comfort. The layout and design is well suited for a couple to handle easily. A great live-aboard or weekend getaway. Alameda slip available.



**SEAWIND 1000, 2001**  
Ready to cruise. \$189,000.



**CORSAIR SPRINT 750**  
2 starting at \$59,000.



**CORSAIR F-27, 1994**  
Go fast have fun. \$39,900.



**FISHER 37, 1979**  
\$82,500



**CORSAIR DASH 750**  
First one to land in the U.S.!

### Northern California



314 Tideway Dr., Alameda, CA 94501  
www.helmsyacht.com  
**(510) 865-2511**

# MULTIHULLS

# SEAWIND

since 1984



## NEW SEAWIND 1160

Seawind's brand new 38-ft sailing cat, the Seawind 1160, has just been launched and is proving to be an immediate success. The new Seawind 1160 combines some of the best features of the earlier Seawind 1000 and Seawind 1200 sailing catamarans. Winner of *Cruising World's* 2007 Boat of the Year.



## SEAWIND 1000 XL

The Seawind 1000 is Australia's most successful cruising catamaran, with the unique combined saloon and cockpit. This model has sailed all around the globe with many offshore passages successfully sailed including through the South Pacific, Hawaii and Alaska.

### Northern California



314 Tideway Dr., Alameda, CA 94501  
www.helmsyacht.com  
**(510) 865-2511**

### Southern California

#### West Coast Multihulls

1053 Rosecrans, San Diego, CA 92106  
www.westcoastmultihulls.com  
kurt@westcoastmultihulls.com  
**(619) 571-3513**



## LETTERS

and a current vaccination certificate. But you might not even be asked for those.

Not once during the previous 15 Ha-Ha's have we heard of anyone having trouble bringing their dog or cat across the border — and there have been plenty. "I don't think Mexico really cares too much," said Chris Frost, owner of Downwind Marine in San Diego. "The hardest part is getting the animal back across the border." Indeed, the U.S. is much more strict about checking documentation, so hold on to those papers for your return trip. Although not required, it's a good idea to make sure your pet has some form of ID, whether on its collar or in the form of an implanted microchip. And if you're planning to sail with Polly the Parrot or Jake the Snake, you have a lot more legwork in front of you.

For more info on sailing with your pets, check out Diana Jessie's *Cruising with Your Four-Footed Friends*, which gives practical advice for cruising with dogs and cats, and the recently released pet health manual *Where There is No Pet Doctor* by David W. LaVigne, DVM (both available on Amazon).

### ↑↓ FIRST DOGS, NOW CATS

The accompanying photo is of our cat Suen resting after 'tailing' the main sheet. It was taken while we were sailing at 3.9 knots on a beam reach between Catalina's Emerald Bay and Marina del Rey on June 22.



LINDA IMMER

"Trim for sun, please," says Suen.

Linda Immer &  
Harris Gabel  
*Always Lucky,*  
Baba 30  
Marina del Rey

### ↑↓ DOGS, CATS . . . AND NOW A BEAR!

When we returned to our home, *Bellavia*, after an extended absence abroad, we found our boat-guarding bear — perhaps a bit bored as a result of being left behind — had started reading a *Latitude* that was somehow left with him. No doubt he was making travel plans.



COURTESY BELLAVIA

Even teddy bears need inspiration.

Milton & Eva Tanner  
*Bellavia*, Passport 40  
Emery Cove

### ↑↓ \$50,000 TO TURN A LEVER

It's nice to read the attitude in *Latitude*. In the last issue you wondered what a drawbridge operator was paid. Last month the California Department of Transportation was taking applications for drawbridge operators in Sacramento, Solano, Los Angeles and San Joaquin counties. The starting salary was listed at "\$3,051-\$3,338/month." That didn't include the benefits, of course.

Jackie Philpott  
*Dura Mater*, Cal 20  
Berkeley Marina

Jackie — So with health, paid vacations, overtime and all that, we're probably talking \$50,000/year — not counting

# Electric Repower

- ▶ Amazing control while docking
- ▶ Direct replacement for Atomic-4
- ▶ Powers up to 33' and 13,000 lbs
- ▶ No fuel smell



Up to **100** mile range at 4 knots with the new PC1800 from Odyssey battery

Get an estimate today!

Contact:

 **SVENDSEN'S BOAT WORKS**  
510.521.8454

 **SolidNav.com**  
The First Alternative for Everyone 1.888.500.2117  
Local installers available. Contact us for details

**GARHAUER**

MARINE HARDWARE

*GREAT  
GEAR*

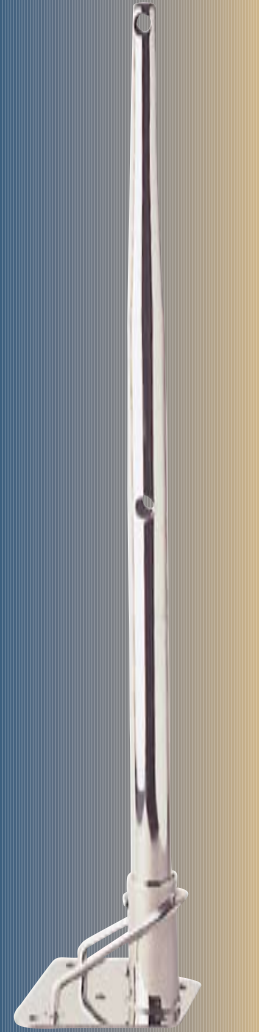

**Quality stanchions and gates from Garhauer**

**W**hether you are replacing one stanchion or upgrading your entire boat, we manufacture a complete line of stanchions, bases and gates.

- Stanchion tubes available in 3 different tip styles
- Stanchions and gates can be made removable or with fixed bases.



**GARHAUER**  
MARINE HARDWARE

1082 West Ninth Street,  
Upland, California 91786

Phone: (909) 985-9993  
FAX: (909) 946-3913

email: [garhauer@garhauermarine.com](mailto:garhauer@garhauermarine.com)  
<http://www.garhauermarine.com>



# SHAFT SHARK

**The best rope,  
line and debris  
cutter there is!**

Two piece unit

For both power and sail

**Now available for  
sail drive systems.**



747 Aquidneck Ave.  
Middletown, RI 02842

**401-847-7960**

Fax: 401-849-0631

sales@ab-marine.com

[www.ab-marine.com](http://www.ab-marine.com)



# Gori propeller

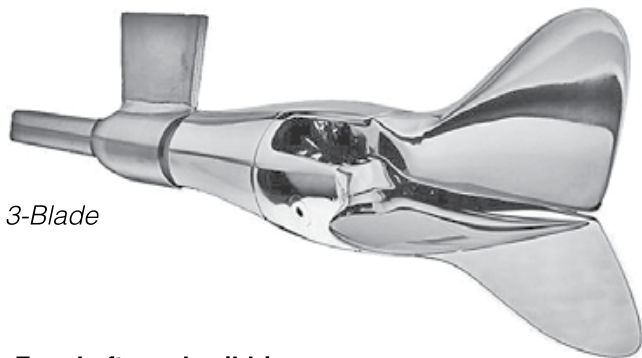

3-Blade

- For shafts and saildrives
- Both 2 & 3 blade available
- Lowest drag when sailing
- The champions choice



747 Aquidneck Ave.  
Middletown, RI 02842

**401-847-7960**

Fax: 401-849-0631

sales@ab-marine.com

[www.ab-marine.com](http://www.ab-marine.com)

**CALL US TODAY!**

**800-801-8922**

## LETTERS

money that will have to be set aside for the pension. And with government workers, the pension is often the huge thing. The Chronicle, for example, recently reported that Pete Nowicki, the 51-year-old retired fire chief of little Moraga, population 16,700, is knocking down \$241,000 a year as his pension. That's only \$660 a day, so we hope the poor guy is going to be able to make ends meet. The not-so-funny thing is that some other retired fire chiefs in Contra Costa County are getting \$50,000 a year more in pension than Nowicki.

Are we the only ones who think that all government operations — police, fire, education and courts — should be turned over to Costco?

### ↑↓ THE BURGEE ARRIVED!

We're excited to participate in the 'Sweet Sixteen' Ha-Ha starting in late October, so we were happy to recently receive our burgee in the mail.



LAURIE MICHEL

**Laurie and Michael are ready to Ha-Ha — how about you?**

Our journey will start in the second week of August, at which time we'll leave San Francisco Bay and visit family and friends as we head south. We will be hanging out at Two Harbors, Catalina, and will be displaying our burgee proudly while we wait for the Ha-Ha to

begin. Thank you to everyone at the Ha-Ha and *Latitude* for putting on the event.

Laurie & Michael Michel  
Laura, Bristol 41.1  
Nevada City

Laurie and Michael — Like you, we're excited, and we'll be spending much of our pre-Ha-Ha time at Two Harbors, getting accustomed to a more tranquil life.

By the way, everyone in the Ha-Ha should be thankful that we live on the West Coast, where historically it's been very easy to sail to the tropics. It's normally a much longer, harder and more challenging trip from anywhere on the Eastern Seaboard to the Caribbean.

### ↑↓ RECRUITING NEW FEMALE CREW FOR THE HA-HA

I've cruised Mexico for all of the last two winter seasons, but the only place my boat has been ripped off was at Stillwater Cove near Pebble Beach. My boat was one of several that were broken into and had all the liquor stolen. Stillwater Cove is also the only place where my dinghy was abused. I found it deflated and filled with sand. Fun!

The only thing that's happened to my dinghy in Mexico is that some Mexican soccer players carefully moved it a few yards down the beach at La Cruz so they could have a bigger soccer field.

I've got to get back to Mexico. The weather here in California, and all the chores, are killing me. I'm doing the Ha-Ha again this year, and am 'recruiting' new female crew.

David Addleman  
Eupsychia, Cal 36  
Monterey

### ↑↓ IT'S GREAT TO BE BACK IN THE U.S. BUT . . .

After spending 10 days doing a Baja Bash, we arrived off



# MARINA BAY YACHT HARBOR

*A Certified Clean Marina*

[www.MarinaBayYachtHarbor.com](http://www.MarinaBayYachtHarbor.com)

**(510) 236-1013**

1340 Marina Way South, Richmond, CA 94804



- A Sunnier, Warmer East Bay Marina
- Restaurant & Deli
- Berth to Bay in 15 Minutes
- 24-Hour Courtesy Patrol

- Deep Draft Harbor (race boat friendly)
- Nearby Boatyards, Chandleries,  
and Fuel



**Tradewinds Sailing School and Club ~ [www.tradewindssailing.com](http://www.tradewindssailing.com)**





**South Beach Harbor is a great way to experience San Francisco. Boats of all sizes are welcome in our protected deepwater harbor. Bring your boat to South Beach and enjoy all the attractions of the city.**



- Two guest docks for boats up to 125'**
- 20 guest berths up to 50'**
- Casual and fine dining nearby**
- Adjacent to AT&T Park**
- Easy access to transportation**
- 24 hour security**
- Free pump-out stations**



**For Reservations:**  
415.495.4911 (x0)  
fax: 415.512.1351  
sb.harbor@sfgov.org  
www.southbeachharbor.com

## LETTERS

Pt. Loma. We hailed the officials at the Police Dock over the VHF, and they told us where to go. Our next stop was Santa Barbara Marina, where it was the same deal. Ditto for Santa Cruz and our homeport of Sierra Point Marina in Brisbane.

While having lunch on our boat at Sierra Point, we stopped to think how different it was in California from Mexico. If we'd called for a slip in a marina in Mexico, when we reached the dock, we would have met by two to four smiling linehandlers, who, as soon as we'd gotten tied up, would have connected our water hose and electricity. And maybe somebody would have offered us some food or a homemade pie, and at the very least filled us in with regard to stores, the internet, restaurants, laundry facilities and transportation. And within 10 minutes, some eager workers would have come by and, at reasonable prices, have offered to wash our boat, clean the bottom or wash our mast.

For a lot of reasons, it's sure good to be back in the old United States — but where is the warm and fuzzy feeling we're used to getting when arriving at marinas in Mexico? We guess that we'll just have to head back south this winter. You wouldn't know of a group of boats that we could hang with on the way down from San Diego to Cabo? Say toward the end of October?

Wayne 'the Mango Man' Hendryx & Carol Baggerly  
Capricorn Cat, Hughes 45  
Brisbane

*Readers — There truly are many wonderful things about California and the United States, but as most people returning from a cruise to Mexico will tell you, while we Americans may have the most money, collectively we're not the warmest of people, nor do we rank among the happiest.*

*After our mother died, our dad kept saying he was going to take his van down to Mexico and do some exploring. Despite our encouragement, he never did, and as such, missed out on meeting many wonderful people and having great adventures. Our advice to those of you who are sick of the 'same-old, same-old' is to not fear the unknown.*

### ↑↓NOT A COMPLAINT, JUST A FACT

With regard to your recent *Lectionic* and *Latitude* items about San Diego and the noise caused by airplanes, maybe you should back off the military and the noise of their jets. After all, they were there before you were.

Capt. Paul Petraitis  
Espresso, CT-41 PH  
Seattle, WA

*Capt. — When we said that San Diego could accurately change its motto from America's Finest City to America's Noisiest City, we were stating a fact and making a joke, not complaining. We actually like the sound of the F-18s — or whatever they are — as we find them reminders of the sophisticated things modern man is capable of producing. After all, nothing in them existed even 100 years ago. Besides, you only hear them a couple of times a day. We find the sound of the commercial jet traffic, which is almost nonstop, more annoying. But as you point out, both Lindbergh Field and the North Island Naval Air Station were around first, so it's a little hard for anyone to complain.*

*By the way, while Profligate was hauled out in San Diego, we spent a bit of time kicking around the redeveloped downtown near Petco Park. The touristy Gas Lamp District is understandably a little cheesy, but overall, San Diego seems to have done a pretty good job. In fact, it feels a lot like the San*

Come visit us today!

# SOUTH BEACH SAILING CENTER

at the  
beautifully renovated Pier 40 in San Francisco

## CAL MARINE ELECTRONICS

ComNav®

### Autopilots

1420

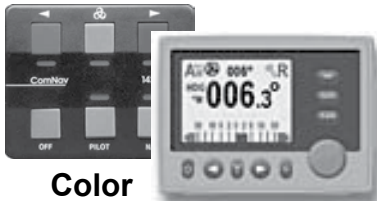

\$899\*

\$2999\*

Color  
Commander

\*Controller, processor,  
compass, rudder ref.

**+10% off install**

Extended 3 year warranty with installation!

**415-391-7550**

[www.calmarineelectronics.com](http://www.calmarineelectronics.com)

## Be Clean and Green



- Mobile Service:  
*We Deliver!*
- Washing
- Waxing
- Varnishing
- Interior Cleaning



### Westwind

Complete Yacht Care

*Serving the entire Bay Area  
for more than 20 years*

**(415) 661-2205**

Pier 40, South Beach on the Embarcadero • San Francisco

Call Toll Free **888-828-6789**

[westwinddetailing@sonic.net](mailto:westwinddetailing@sonic.net)

[www.boatdetailing.com](http://www.boatdetailing.com)



*Design, Fine Yacht Upholstery,  
Fabrication, Etc.*



YACHT: LIN MAR

**NORTH  
BEACH  
MARINE  
CANVAS**

**415.543.1887**

[nbmc@earthlink.net](mailto:nbmc@earthlink.net)

[www.northbeachmarinecanvas.com](http://www.northbeachmarinecanvas.com)

Pier 40, The Embarcadero  
South Beach Harbor, San Francisco

## South Beach Riggers

**Winning  
Technology for  
the Hot Race or  
the Casual Cruise**

- Expert advice, sales and splicing of Vectran, Spectra, Technora, and Dacron by our certified splicer
- Professional survey and tune for your rig
- Standing and running rigging replacement
- Fabrication and hydraulics
- More than 100,000 miles racing and cruising experience



**TWO LOCATIONS**

**399 Harbor Dr. • Clipper Marina • Sausalito • 415.331.3400**  
**Pier 40 • South Beach Harbor • San Francisco • 415.974.6063**

Adjacent to South Beach Harbor and AT&T Park • Close to dozens of fantastic restaurants and shops



❖ **ALAMEDA'S  
FINEST SLIPS  
AVAILABLE AT** ❖

**OPEN  
HOUSE  
in August**



*Home of*  
**ALAMEDA  
YACHT CLUB  
MEMBERSHIP  
DRIVE**

**Complimentary Lunch**

**Saturday, August 15  
11 am-5 pm**

Sheltered Alameda Location  
Competitive Rates

1535 Buena Vista Ave., Alameda, California  
**(510) 522-9080**

**For directions and rates go to:  
www.fortman.com**

## LETTERS

*Francisco waterfront — except that it's 20 degrees warmer and there aren't any homeless people.*

### ↑↓ **PIRACY PROFITABLE FOR INSURANCE COMPANIES**

I read your editorial response in the June issue expressing surprise that governments of the world allow piracy, such as that which happens off Somalia, to continue. I hate to be such a cynic, but piracy will not end near Somalia because it's so profitable — for maritime insurance companies. All insurance companies now assess a surcharge for commercial shipping that transits the area. The total income to the insurers for those surcharges has been more than \$30 million in the past year. The total payouts for ransoms, cost of negotiators and so forth? Less than \$1 million. These kinds of numbers would warm an actuary's heart, wouldn't you say?

Dean Koutzoukis  
Yorba Linda

*Dean — We're probably even more cynical than you are, but just because there hasn't been a major claim yet doesn't mean there won't be one in the future. After all, it's entirely possible that some pirates will sometime show they 'mean business' by destroying a tanker carrying \$100 million in oil. In that case, the insurance companies would be \$70 million in the red. Risk assessment is a tricky business. Whether it's more profitable in the long run than other endeavors — such as piracy — is unclear.*

### ↑↓ **TWENTY-SIX YEARS AGO IN THE LIGHTBUCKET**

A few years ago a guy — I can't remember who — gave me a great photo that shows 'old school' sailing. It was taken during the '83 Lightship Race, when it was blowing up to 46 knots, the Bonita Bar was breaking, and the waves were really big.



COURTESY STEVE BATES

**Old school sailing in the Gulf of the Farallones.**

I was crew aboard a Santa Cruz 27, and we were sailing with a single reef in the main and a #4 jib. After sailing through a breaking wave at Bonita, we rounded the Lightbucket, put up a #3, and still did 16 knots with a reef in the main! We didn't wear PFDs back then, but we did wear harnesses.

I must be getting nostalgic — it does seem that much of that 'old school' sailing was done in less-than-perfect conditions and, God knows, less-than-perfect boats. It's hard to explain to younger sailors.

Steve Bates  
Wind Blown Hare, Wylie Wabbit  
Richmond YC

*Steve — There certainly was some wild 'old school' sailing in the '70s and early '80s. We can remember when people used to race small boats — such as Cal 20s, Coronado 25s and Ranger 26s — in the Midget Ocean Racing Association's long distance races from San Francisco to San Diego and even Ensenada. Even for those who weren't on drugs — and some of the crews were — it was a mystical experience when the wind got over 30 knots and the seas started to break.*

*But we hope you're not disparaging the SC 27, a design*

# Your Home Port for Service & Refit



From yachts to commercial vessels, our 88 Ton Travelift, full-service yard, on-site naval architect, and upcoming yacht center makes us the only home port you need.

## **Full Service Boatyard:**

- Complete Propeller Shop
- Electrical Repair & Installation
- LPU Painting
- Complete Machine Shop
- Shipwrights – Caulking & Carpentry
- Complete Chandlery
- Gas, Diesel & Stern Drive Repair
- Mast & Rigging Repair
- Sandblasting & Epoxy coatings
- Fiberglass & GelCoat Repairs
- 5-Acre Repair Facility
- Insurance Work Welcome

## **New On-Site Performance Rigging by GC Marine Services**

Your Authorized Sales & Service Source For **VOLVO PENTA** 



Reserve Your Haulout Today: 1-800-900-6646 • New Management • [www.baymarineboatworks.com](http://www.baymarineboatworks.com)

Learn More About Our Authorized Dealer and Repair Services: [www.baymarineboatworks.com/authdealer.htm](http://www.baymarineboatworks.com/authdealer.htm)

310 West Cutting Blvd. • Pt. Richmond, CA • Fax: 510-237-2253 **GC Marine Services: 415-533-2915**



# BLUE WATER YACHT INSURANCE

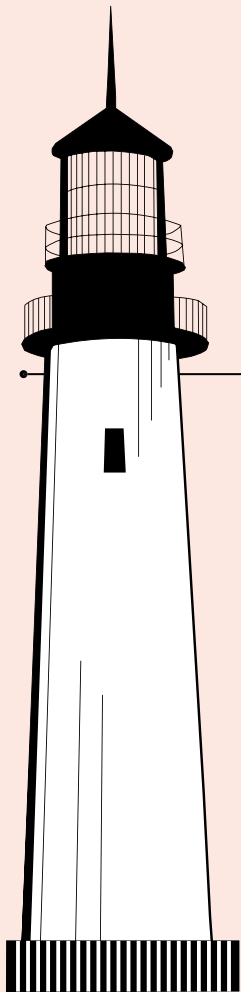

Blue Water Yacht Insurance covers more active cruising boats than any other marine agency in the Western Hemisphere, and is the leading innovator of insurance products for the offshore sailor.

## Our Insurance Programs Provide:

- Crew of two anywhere
- Worldwide Navigation
- Hawaii
- Caribbean
- South Pacific
- Mexico
- Charter Boats
- Multihulls
- Liveaboards
- Racing Boats

## Quality Rated Insurance Companies

Boats aged 1 to 40 years • "Agreed Value"  
"All Risks" • "New for Old" replacement partial losses  
Hulls valued \$50,000 to \$2,500,000

## Worldwide Health Insurance

International and USA health insurance plans  
at affordable prices.



BLUE WATER  
INSURANCE  
JUPITER, FLORIDA • USA

Call Toll Free  
**(866) 463-0167**  
Fax: (866) 795-3707  
sales@bluewaterinsurance.com

Quote requests  
Visit our website

[www.bluewaterinsurance.com](http://www.bluewaterinsurance.com)

## LETTERS

that won at least one particularly windy MORA Long Distance Race, and that Norton Smith used to win the first Singlehanded TransPac.

While 'old school' sailors had a lot of balls and were fine sailors, we don't think they can touch today's top young sailors, who have benefitted from so much better knowledge, training and experience.

### ↑↓**AW SHUCKS!**

I seldom actually have time to read a whole issue of *Latitude* 38. But I was a bit under the weather on a recent Sunday, and started to read the May issue. I loved it! I read it cover to cover, and thought it was a great mix of information and entertainment. Thanks to you and the whole gang for a very pleasant bit of 'brain-candy'!

Deborah Atherton  
Pier 39 Marina  
San Francisco

*Deborah — It's very hard work putting each issue together because our staff really cares and really tries hard. It's nice to know that you and others appreciate it.*

### ↑↓**YOU SHOULD BE A PROCTOLOGIST**

I've been reading *Latitude* since the beginning. Between *Latitude* and *Vanity Fair*, it's always a long wait between issues. That said, I just wanted to compliment the *Latitude* editor's skill at retorts. No issue of *Latitude* is a real issue unless some misguided armchair powerboater pipes up about something he knows nothing about and writes to *Latitude* about it. I think these are the same voids who leave inane, mean and downright hateful messages on comments about newspaper stories and blogs they find "disquieting."

My point? The *Latitude* editor should really be a doctor. Specifically a proctologist — because no one rips them a new asshole like you do! I love reading your responses. They are right to the fuckin' point! Touché! En garde!

Peter Kissam  
Marine Electronics  
Newport Beach

*Peter — Geez, we're just trying to be helpful, not mean.*

### ↑↓**ROSE STILL WELCOMES CRUISERS TO NUKU HIVA**

It's been a long time since I've been in contact with *Latitude*, but I wanted to check in to let you know I am still here at



ROSE CORSER

*The view from the restaurant from the new He'e Tai Inn on Nuku Hiva.*

Taiohae Bay, Nuku Hiva, Marquesas Islands. There have been many changes in the bay over the years — and even in just the last few months — things such as the much greater availability of fresh food, and construction in the valley. I'll send you complete information before next year's cruisers start heading here.

As you probably remember, for 21 years I was the owner of Keikahanui Inn, and hosted a six-days-a-week happy hour for yachties during the January through August season. Nine years ago I took on partners, and the Keikahanui Inn became



# Ullman Sails

*Changes in Latitudes*  
=  
*Changes in Attitudes*

Don't miss the party! The Baja Ha-Ha starts before you leave the dock!

Make the most of your trip by having your sails professionally inspected and serviced.

Call us about  
our special  
**BAJA HA-HA**  
discounts!



**CONTACT AN ULLMAN LOFT OR REP FOR SERVICE AND SALES**

**Nine Lofts/Dealers to service your sailing needs down the Coast between Seattle and San Diego:**

**Newport Beach**

(714) 432-1860  
2710 S. Croddy Way  
Santa Ana, CA 92704  
Dave Ullman  
Bruce Cooper  
Steve Beck  
Erik Shampain  
John Bennett

**San Diego**

(619) 226-1133  
2805 Canon St.  
San Diego, CA 92106  
Chuck Skewes  
Tom Niebergall  
Jim Clinton

**Long Beach**

(562) 598-9441  
6400 Marina Drive #9  
Long Beach, CA  
90803  
Bryan Dair  
Steve Beck  
(562) 243-9710

**Marina del Rey/  
King Harbor**

Mike George  
(310) 645-0196  
Steve Beck  
(562) 243-9710  
**Sacramento**  
Wade Behling  
(916) 804-5682

**Ventura**

(805) 644-9579  
3639 E. Harbor Blvd.  
#111  
Ventura, CA 93001  
Gary Swenson  
Deke Klatt

**Santa Barbara**

Ken Kieding  
(805) 965-4538  
Gary Swenson  
(805) 644-9579

**Santa Cruz**

Brent Ruhne  
Ruhne Racing  
(831) 295-8290 mobile

**Seattle**

(206) 234-3737  
2370 Fairview Ave. E  
Seattle, WA 98102  
Chris Winnard  
Jeff Carson  
Jon Thompson  
John Leitzinger



Visit our website: [www.ullmansails.com](http://www.ullmansails.com)

## 2009 OUTBOARD CLEARANCE\*



- Best prices of the year!
- Quiet, 4-stroke technology
- Unsurpassed fuel economy
- Transistorized pointless ignition
- Ideal for sailboats, small tenders



POWERED BY

**HONDA  
MARINE**



© 2009 American Honda Motor Co., Inc.

Always wear a personal flotation device while boating and read your owner's manual.  
5-year warranty standard on all new Honda outboard engines purchased.  
Check with participating dealers for complete details.

\*All makes and models. Limited to inventory in stock. 2010 models arriving soon.

**Outboard Motor Shop**  
Where the professionals shop!

(formerly Seapower Marine)

**(510) 533-9290**

[www.outboardmotorshop.com](http://www.outboardmotorshop.com)

333 Kennedy St., Oakland, CA 94606 • Fax 510-533-3374

**WOODEN BOAT 33 FESTIVAL**

**WORKING WATERFRONT**

SEPTEMBER 11, 12, 13, 2009  
PORT TOWNSEND, WASHINGTON  
POINT HUDSON MARINA ~ FOR TICKETS & INFORMATION:  
**WWW.WOODENBOAT.ORG**





C. SHERMAN JOHNSON CO. INC.  
**Johnson**  
*Marine Hardware*

# KEEPING YOU CONNECTED FOR 50 YEARS!

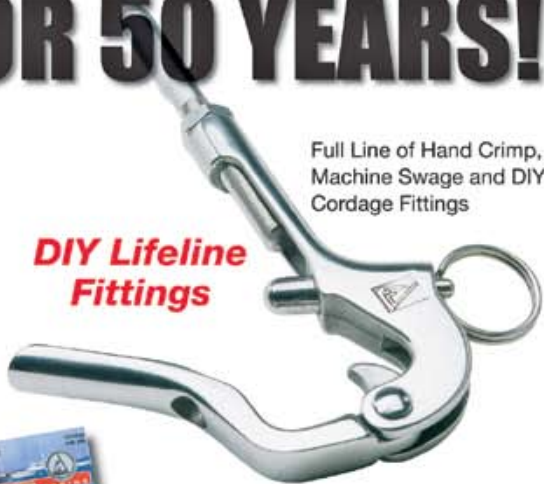

Full Line of Hand Crimp,  
 Machine Swage and DIY  
 Cordage Fittings

**DIY Lifeline  
 Fittings**



**Unique  
 Accessories**

Grab 'n Go™ Hook

**Rigging  
 Hardware**



Calibrated  
 Turnbuckle



C. Sherman Johnson Co., Inc.  
 East Haddam, CT  
 1-860-873-8697

[www.csjohnson.com](http://www.csjohnson.com)

## LETTERS

the Keikahanui Nuku Hiva Pearl Lodge — one of several in a chain. Two years ago I sold my stock in the hotel. I'm now in the process of building an eight-room hotel with waterfront restaurant beside the road that continues up to the Keikahanui Inn. My new place will be called He'e Tai Inn — Marquesan for 'from the sea' — and I intend to make it the yacht club of Taiohae Bay. The restaurant, which is finished but not yet officially open, will feature cultural programs such as traditional



ROSE CORSER

**Rose Corser, a long-time friend of cruisers, at her museum at Taiohae Bay.**

Marquesan dancing, roast pig buffets, and so forth. These cultural activities have been missing since I stopped running the Keikahanui.

It was only by meeting some cruisers in my museum/boutique that I learned that something called the Pacific Puddle Jump, with 60 or so participants, arrived in the Marquesas this year, and that *Latitude* is a sponsor. I hope you'll keep me informed, as I'll be happy to help out in any way that I can.

By the way, I still actively handle mail for cruisers. In this age of email, it's mostly urgent packages containing parts for boats, many of which are still at sea. For anyone needing to send packages via FedEx or DHL, make sure they are addressed to Yacht Name (fill in blank), c/o Rose Corser, Taiohae, Nuku Hiva, Marquesas. Be sure to write 'Yacht Replacement Parts — Yacht in Transit' on both the package and the invoice. To clear these packages through customs, I need a copy of the captain's passport, ship's document, and the clearance by the gendarmerie on entry. Many cruising guides include the above information, but add the name Keikahanui Inn, which no longer exists. This has complicated some clearances, so use my name only.

Looking forward again to hosting the 'happy hours' with the fascinating variety of persons from all over the world. As our previous sign indicated — a place to enjoy good food and drinks, and listen to 'tall tales.'

Rose Corser, Hotel He'e Tai Inn  
 Museum Boutique Enana  
 Taiohae, Nuku Hiva 98742, Marquesas, French Polynesia  
 Tel: 689-920382 Satellite phone: 689-735312  
[marquesasrose@gmail.com](mailto:marquesasrose@gmail.com) or [rose.corser@mail.pf](mailto:rose.corser@mail.pf)

*Readers — We've never met Rose, but from the late '70s on, she and her Keikahanui Inn were the friendly home away from home for yachts that had just crossed the puddle. This bond was particularly strong back in the days before the internet and email, when Nuku Hiva was effectively a very remote place, and Rose was one of the few sources of information and aid. We're sure many old-time cruisers will smile to learn that Rose is still welcoming cruisers in the Marquesas.*

*Like Rose, a lot of people are curious about the relation between Latitude 38 and the Pacific Puddle Jump. The way we see it, Latitude is the 'custodian' of the event for each year's new group of cruisers, who are the real 'owners'. Latitude spends quite a bit of money each year to promote the event,*

# Yacht owners can trust **PACIFIC CREST CANVAS\*** for the best in design, service and quality.

- **Offshore Dodger™**

Welded aft handrail  
Bolt-on side handrails  
Lexan windshields

- **Baja Awning™**

Lightweight and waterproof  
Durable and easy to launch  
Multiple side screen configurations

## *Our Sailor Stimulus: Still the Highest Quality Products at the Best Prices*



*Pete Fuller, a professional Bay Pilot with good taste in both fine sailing yachts and offshore dodgers!*

- **Coastal Dodger™**

Affordable designs  
Same high quality materials  
Same superior workmanship

- **Cruiser's Awning™**

Easy setup off your dodger  
Flies with no bulky frame  
Comes with shade screens

Open Monday-Friday 8:00-4:00  
Saturday by appointment  
**(510) 521-1938**



2021 Alaska Packer Place  
Alameda, CA 94501  
Grand Marina

*\*Former owner at Pacific Coast Canvas*



North Winds Canvas  
7911 NE 33rd Dr. #390  
Portland, OR 97211  
503-282-4282

**Stay cool in...**



Relax on your boat under this airy and lightweight shade. This simple and elegant design creates a whole new room in your cockpit, with no permanent fittings to install.

**www.shop.nwcanvas.com**

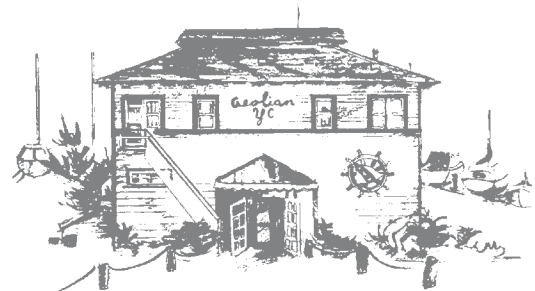

The **Aeolian Yacht Club** is pleased to host the U.S. Coast Guard Auxiliary 'Boating Safety' class, open to the Bay Area boating community.

**When:** Saturday, August 22, 2009

**Time:** Registration begins at 8:00 a.m.  
Class from 9:00 a.m. to 5:00 p.m.

**Cost:** \$35 for materials, lunch and snacks  
or \$25 for materials only.

**Registration Deadline:** August 12, 2009  
**Registration is limited to 30, so sign up early!**

**Contact:** Sherri Armijo at (510) 523-2586  
or email [aeolianyc@aol.com](mailto:aeolianyc@aol.com) to sign up!

**Aeolian Yacht Club**  
980 Fernside Boulevard, Alameda, CA 94501





## NEW EDITION!

### CHARLIE'S MEXICO

### Including BAJA

Major revision in 2009

- Over 90 pages updated or added including:
- The simplest way to obtain a Temporary Import Permit
- Glossary of over 200 mechanical terms in Spanish
- Index of all marinas and boatyards
- Expanded coverage of La Paz marinas and services
- Location and contact information for dry storage yards
- Annexo 1, a form to avoid duties on replacement parts

Available at marine stores and online at [www.charliescharts.com](http://www.charliescharts.com)

## LETTERS

*but as there is no entry fee, so we derive no revenue from it. Brilliant business model, isn't it?*

### ↑↓OUR BOATS HAVE HAD AN "ARK-LIKE ESSENCE" SINCE

*Latitude* asked about readers' experiences with the Quake of '89. I was an incorrigible workaholic in the tech industry at the time, and my rigid 'work hard, play hard' mentality translated into 60+ hours Monday through Friday, and — thank God — a little sailing on Saturday and Sundays. On October 17, I attended an all day offsite department meeting in Los Gatos. It ended much earlier than scheduled, at around 2 p.m. Nine hundred and ninety nine times out of 1,000, I would have beelined it back to the office. For some reason — perhaps it was



COURTESY KIAPA

'Kiapa', Pete and Susan's latest ark, as seen at San Simeon anchorage.

the nice weather, perhaps it was the fact that there were a number of sailors in the department — I decided to head up to the City for an afternoon sail with a couple friends. We kept our boat at South Beach Marina at the time, and after a quick stop for

some ice, beer and snacks, we were all ready to go at around 4 p.m. After untying the dock lines, we sailed north under the Bay Bridge toward the center of the Bay.

Two things happened simultaneously at 5:04 p.m., when we were 200 yards from the Ferry Building heading north-west. One, thousands upon thousands of birds, all around the horizon, took flight for no apparent reason. It was like something out of a creepy Alfred Hitchcock movie. Two, we felt a light jarring — sort of as though we'd run aground on a flat, sandy bottom.

At first, we didn't know what to make of it. But things slowly came into focus. I think the first thing we noticed was that the clock tower on the Ferry Building had been damaged. Soon, we saw smoke from fires burning along the Embarcadero, then fires on the Oakland side of the Bay, then finally big plumes of smoke coming over the hills to the west from the fires in the Marina District.

We carried a boombox with a radio for tunes. I jumped belowdecks to grab it, but in my haste managed to drop it. The batteries fell out and rolled to all corners of the boat. Rather than put it back together, I grabbed our little battery-powered portable TV instead and turned it on. All we got were 'test patterns' on all the channels. For a second, we thought it was the end of the world. The last thing we noticed was what was happening on the Bay Bridge. The traffic hadn't been moving for a few minutes, and then finally we saw a huge mass of people running westbound across the bridge toward the City. That image was just like the panic scene from a Godzilla movie.

After some time, the television came back on, and we were riveted by the news. My wife had gone to a training session in Oakland, so having heard about the collapse of parts of the upper deck of the Nimitz freeway, I had all kinds of worst case scenarios running through my mind. Our kids were in the South Bay at soccer practice, unsupervised. The initial news reports were, thankfully, much worse than the ultimate reality. We heard that all freeways were closed and that nobody could leave the City.

We returned to South Beach Harbor to wait for news and

## CAPTAIN'S COURSES

Classroom classes in 15 cities and now Online!



## Captain's License

U.S. Coast Guard approved courses and testing. Approved for Veterans.

### Classroom or Online?

We believe the interactions and structure of a classroom provide the best training experience. Even so, for some students attending a scheduled course just isn't possible. There is a solution.

### We now offer courses Online!

Whether you choose traditional classroom or the new online courses, rest assured we'll hold to the same high standards we've maintained for over thirty years.

### Our next San Rafael class begins Oct. 19th

Check our website schedule for other locations and courses.

## MARITIME INSTITUTE

To enroll or for more info: [www.MaritimeInstitute.com](http://www.MaritimeInstitute.com) or CALL TOLL FREE 888-262-8020

# LOCH LOMOND MARINA

**MOVE-IN  
SPECIAL:  
FIRST MONTH  
FREE!**

**Completely Rebuilt Marina • Gas & Diesel Fuel Dock  
Free Pump Out Station • Modern Launch Ramp  
Guest Slips Available • Marine Mechanical Boat Repair  
Arena Marine Supply Store • Loch Lomond Market**

**110 Loch Lomond Drive, San Rafael, CA 94901**

**Phone: (415) 454-7228 • Fax: (415) 454-6154**

**www.lochlomondmarina.com**

**Harbor Master – Pat Lopez • pat@lochlomondmarina.com**



**"What did he just say?"  
Last Call  
MARINE RECORDING SERVICE**

**only \$109.<sup>95</sup>**



- Repeats last transmission from your VHF radio with one push of the button
- RCA jack / 12-volt DC
- Visit [www.LastCallMarine.com](http://www.LastCallMarine.com) for Web demo and to order yours today

**Chosen by Washington State Ferries  
for use in its entire fleet**

**Special Introductory Offer:  
Buy one, get one FREE!**

**www.LastCallMarine.com**

**Made in the USA!**



## Got Shade?

- Ingenious, self-supporting awning system, attaches to lifelines
- Tall enough to walk under at cabin, no limbo
- Bombproof construction, easily sustains 25 knots
- Sets up in 10 minutes, stows complete in its own 10" x 36" bag
- 10 standard sizes fit any boat, catamarans too
- Prices from \$300.00 to \$700.00

Visit: [www.intheshd.com](http://www.intheshd.com)

**ShadeTree**  
888-684-3743  
[shadetre@gulftel.com](mailto:shadetre@gulftel.com)

**shadetre**  
Relax Under A ShadeTree



## 31% OF BOATS AREN'T INSURED

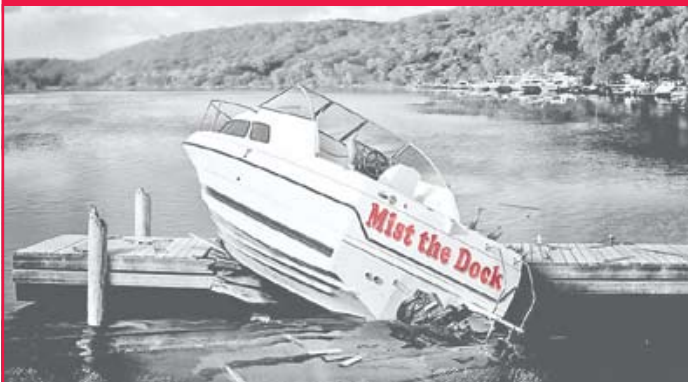

I can help make sure you don't get stuck with 100% of the cost. For less than \$1 a day\*, Allstate Boatowners Insurance can cover things like injury, theft and damage to your boat – or someone else's. Don't wait until it's too late. Call me today.

**ALAN D. QUAN**  
Insurance Agent  
(800) 792-9530

AlanQuan@allstate.com  
CA Lic: 0745657



\*Based on 2006 countrywide average gross premium for boatowners insurance. Your actual premium will vary based on state and value of boat. Subject to availability and qualifications. Allstate Indemnity Company, Northbrook, IL. © 2009 Allstate Insurance Company

## LETTERS

phone connections. All of us aboard were incredibly concerned about our families and friends. Yet there was an almost creepy irony that, there we were, safely on a boat in the marina, with plenty of power, pretty good communications (TV, VHF, sideband, etc), and plenty of food and fresh water. If only we could beam our families on board.

Since that day, our sailboats — later a Farr 44, a Santa Cruz 52, and now our M&M 52 catmaran — have always had an Ark-like essence for me. And we'll never forget that afternoon sail.

Pete & Susan Wolcott  
Route du Vent (in '89)  
Currently Kiapa, Morrelli & Melvin 52  
Kapa'a, HI

### ↑↓SHE WORKS HARD FOR THE MONEY

I am writing to express my eye-rolling disappointment in the Liz Clark piece — with the overly dramatic title “An SOS from Liz Clark on Swell” — in the May 11 edition of *Lectronic Latitude*. At first I was worried there had been an accident or that Liz was in other serious trouble. As it turns out, this was not a true SOS; Ms. Clark is simply in need of money. Who isn't in need of money these days? I completely understand that Ms. Clark needs the money to repair her boat so she may continue her sailing and surfing adventure, but considering the economic climate back here in 'Reality World', it strikes me as odd that a person capable of getting the initial funding and multiple sponsorships at the journey's onset, would now feel it's appropriate to ask for donations from the general public.

And if she has, as you wrote, “made the transition from a relatively novice sailor to a courageous and competent adventurer, never shying away from the hard work that's needed to be done,” it seems to me she should consider getting a job in one of the fabulous locales she's been privileged to visit, or even back home, to earn the \$5,000 she feels she needs.

In reading some of her blog entries, I find it hard to believe that a person with the stamina and courage to sail alone to the South Pacific and the determination to conquer the surf at Teahupo'o would ask working people for money while she spends her days exploring, sailing, and surfing in exotic ports. I find this more than a little offensive, considering I work hard for my money so no one else has to foot the bill for my fun.

Perhaps the generous souls who are considering sending money to Liz Clark should instead send their contribution to Bismarck Dinius — someone who is truly in need of help!

Kathe Hashimoto  
Seahound, Cal 27 T2  
Sausalito

*Kathe — You're not the only one who feels the way you do, but we think you're overly grouchy about it. As for your complaint that you were worried Liz had been in an accident — please, you can't seriously believe that she would call for urgent help via the online edition of a sailing magazine!*

*In addition, it's not as though Liz was asking for donations from the “general public.” Over the last three years, she's written many interesting and well-received pieces for Latitude and other publications, and we think she rightly felt that some readers might be happy to pitch in a little to help her out. She received over \$1,400, and has expressed her sincere gratitude to all those who contributed.*

*What we can't figure out is if you've got something against everyone who receives money from others to go sailing — which as we mentioned last month, would include Robin Lee Graham,*

## Get Connected!

a complete solution for global phone & email



### Iridium engineered for your installation

- Cradle with data connection
- High gain antenna
- Privacy handset
- Coax selection
- Connectors

#### Software and Service

- Data compression
- Email
- Weather + GRIB
- Position reporting
- SailBlogs / Yotreps

**AirMail**  
Version 3.4.034

**SailMail**  
no longer just for SSB

**Farallon Electronics**

Sausalito, CA since 1989 www.farallon.us 415 331 1924

# Emeryville Marina

ON THE BAY

When you call Emeryville Marina Home...  
...call this your backyard!

Free Wi-Fi  
and Video  
Surveillance

Slips from 20-65 ft  
Full Amenities - including  
Fuel Dock & Pumpout Station

(510) 654-3716

[www.emeryvillemarina.com](http://www.emeryvillemarina.com)

MARINAS  
International

New Member  
Showers and  
Laundry Facilities  
Now Open!

**NEW SLIPS!**

Available Fall/Winter 2009  
Now taking reservations  
for 40' to 60'

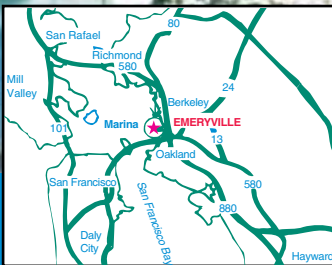

## SWISS TECH SPECIALTY SAILING GEAR

Designed and tested for world-wide cruising and rigorous seamanship challenges à la Baja Ha-Ha



### MAST LIFT Our Signature Product!

- 10-to-1 winch hoist for safe and easy mast climbing, easy MOB maneuvers, and other hoist tasks
- Top-of-the-mast safety harness & bosun's chair

See us at the  
Annapolis Boat  
Show

### The Authentic Self-Retracting Anchor Buoy



Mooring  
Safety Lock

### Mooring Gear

Seamanship products for catching mooring buoys, bullards and mooring posts with self-releasing mechanisms

Your purchases will trigger a 5% increase to Swiss Tech America's regular sale-to-sale contribution to Make-a-Wish Foundation.

Please see our Flash animated product descriptions at:

[www.swisstech-america.com](http://www.swisstech-america.com)

(408) 505-SAIL (7245)

WELL CARED FOR SPECIAL

\$33/FT

BOTTOM JOB!\*

Only at Nelson's Marine

If you take good care of your boat,  
we'll take good care of you.

See our best boat brokerage listings at:  
[www.nelsonyachts.net](http://www.nelsonyachts.net)

**Nelson's Marine**

[www.nelsonsmarine.com](http://www.nelsonsmarine.com)

1500 FERRY POINT, ALAMEDA, CA 94501

(510) 814-1858 • FAX (510) 769-0815

\*Price upon approval for clean, well-maintained boats.



ELECTRICAL SHOP NOW OPEN - COME BY



## Sausalito Marine

Electrical Shop "The Project Place"

300 Harbor Drive Sausalito, CA 94965 - (415) 332-9030

LARGEST SELECTION OF **BLUE SEA SYSTEMS** PRODUCTS ON THE BAY & AT THE BEST PRICE



Sausalito Marine is the Bay Area's first ever Full Service Marine Electrical Chandlery. Referred to as "The Project Place", we want you to come in and tell us about your project.

www.sausalitomarine.com - info@sausalitomarine.com

## McDERMOTT COSTA

insurance brokers - est. 1938

### Commercial Operations

- COMMERCIAL POLICIES  
Marinas, Yards, Yacht Clubs, Brokers, Shipwrights

### Pleasure Yachting

- YACHT & BOAT POLICIES  
Offshore, Coastal, Inland and Liveaboards



Lic. #OB21939

Bill Fowler

McDERMOTT COSTA INSURANCE  
(925) 606-6606 Fax (510) 357-3230  
bfowler@mcdermottcosta.com



## LETTERS

Tania Aebi, Zac Sunderland, Bruce Schwab and about a million racing sailors — or if you just have a problem with Liz? And if it's the latter, is it because she's young? A woman? Or because she often appears to be having fun?

**RESPONSE HIJACK ALERT!** Editor LaDonna Bubak stepping in here to point out that not everyone at Latitude agrees with the boss man — and praise Ra that he's got a good sense of humor about it.

Kathe clearly respects Liz Clark's gumption, and at the very least follows her adventures online, if not in the magazine. To suggest she has "a problem" with Liz because she's "young" or "a woman" is not just silly, it's downright offensive — especially if you've ever laid eyes on Kathe (to do so, check out page 98 of this issue).

And The Wanderer's suggestion that Liz Clark's request for money in any way resembles that of a professional racer's quest for sponsorship is apples, well, and watermelons. Liz's solicitation is more like the guy at a rest stop begging for gas money. Liz, as well as the others he mentions, obviously received donations to fund their dream trips — and good on 'em! But the others — who were all out to break records, by the way — somehow secured their funding without asking me for a dime.

For the record, I think Liz is extremely courageous for following her dream and heading off into the great blue on her own. But the next time she needs a few extra bucks to continue her vacation, maybe she should just get a job.

### WE'RE DEFINITELY DOING DELTA DOO DAH DEUX

Nancy and I want to give our heartfelt thanks to everyone at Latitude but especially LaDonna Bubak, Christine Weaver,



LATITUDE / LADONNA

and John Arndt for organizing and running the Delta Doo Dah. The week we spent on the Delta as part of the Doo Dah was one of the best vacations we've ever had.

After sailing on the Bay for 38 years, we needed you guys to kick us in the ass to get on up the river. Now we're kicking ourselves in the ass for not having done it sooner. We're already organizing another trip up there in the fall but, if that doesn't work out, certainly next year with all of our friends who also need to be kicked in the ass to get on up the river. Doo Dah II — we're there!

Gary & Nancy Ryan  
'iliahale, Hanse 34  
Greenbrae

Readers — You can get all the dirt on the Doo Dah starting on page 98. While next year's dates haven't been confirmed, it seems a foregone conclusion that Delta Doo Dah Deux is a go.

In a typical month, we receive a tremendous volume of letters. So if yours hasn't appeared, don't give up hope.

We welcome all letters that are of interest to sailors. Please include your name, your boat's name, hailing port, and, if possible, a way to contact you for clarifications.

By far the best way to send letters is to email them to richard@latitude38.com. You can also mail them to 15 Locust, Mill Valley, CA, 94941, or fax them to (415) 383-5816.

# BERKELEY MARINA



**Centrally located off Hwy. 80 at University Ave. • Fast Access to the Central Bay • Fuel Dock • Marine Center with 35 Ton Lift Capacity • Launch Ramp • Waterfront Hotel • Restaurants • Adventure Playground • 17 Acre Off-leash Dog Park • Picnic Sites • Deli and More...**



**CITY OF BERKELEY**  
PARKS RECREATION AND WATERFRONT

**Berkeley Marina Office**

**201 University Ave. • 510-981-6740**

Visit our website at: [www.ci.berkeley.ca.us/marina](http://www.ci.berkeley.ca.us/marina)

## frigoboat®

**Keel Cooling System**

- No Pump
- No Fan
- No Noise



Arguably the world's most efficient, dependable refrigeration. The keel cooler and super efficient compressor make for a quiet, highly efficient 12V refrigeration system.



## SWEDISH MARINE

1150 BRICKYARD COVE RD., SUITE B6  
PT. RICHMOND, CA 94801 (510) 234-9566



**Service of the Month**

## POLISHING

A buffed boat not only looks great, but will hold its shine and value for longer!

*Call for a buff!*

**ADDITIONAL SERVICES**

**Bilge Cleaning • Detailing • Maintenance  
Washdown • Carpet & Cushion Cleaning**

**Fully Insured & Marina Approved**

**Serving the Bay Area Since 1986**

**Call now for a Free Estimate**

**510 428-2522 or 415 457-6300**

**[www.seashine.net](http://www.seashine.net)**



# SIGHTINGS

## more america's cup drama

As any design rule in any competitive arena matures, performance gains become more a result of refinement and less a result of radical departures in concept, and that's exactly what happened over the last couple America's Cups.

But when you blow the design parameters as wide open as the impending Deed of Gift match for the 33rd America's Cup has, the question of concept suddenly becomes quite relevant. As last month's launching of Alinghi's answer — *Alinghi 5* — to the Golden Gate YC's challenge has shown, there is little consensus between the two teams as to what is more suited for the match: a trimaran — as has so far been shown to be BMW Oracle's choice — or a catamaran — as Alinghi have chosen. What they share is that they're both absolute

continued on outside column of next sightings page

## the final hawks

Alonso Machain, the last of five people convicted in connection with the murders of Newport Beach-based cruisers Tom and Jackie Hawks, was quietly sentenced to 20 years in California state prison on June 15. Machain, the key witness in previous trials, pleaded guilty and struck a plea agreement with prosecutors, which the Hawks family supported.

On November 15, 2004, Tom and Jackie Hawks took Machain, Skylar Deleon and John Kennedy, posing as buyers, on a sea trial aboard their 55-ft trawler

**Get along, little DOGie — 'Alinghi's Deed of Gift match multihull will make for interesting A-Cup viewing.**



PHOTOS CARLO BORLENGHI / ALINGHI



## killer sentenced

*Well Deserved.* At sea, the men subdued the Hawkses, forced them to sign financial and legal documents, tied them to an anchor and threw them overboard.

Deleon's then-wife, Jennifer Henderson, was sentenced in 2006 to life without parole for assisting in the plot. Deleon and Kennedy were both sentenced to death last year. A fifth defendant, Myron Gardner, pleaded guilty to putting Deleon in touch with Kennedy. He was sentenced to a year and is now free.

— *ladonna*

## a-cup — cont'd

monsters.

*Alinghi 5* turned out to be a 90-ft catamaran, the result of more than 100,000 man hours in design and build. A development of Ernesto Bertarelli's 41-ft Lake Geneva day racer *Le Black*, *Alinghi 5* sports some unusual features for a catamaran. First, the pair of diagonal beams that emanate from the area of the mast step and run to the rear crossbeam to counteract the bending loads created by the running backstays. Then there's the complex web of dolphin-striker, cables and rods that stiffen the entire package both torsionally and longitudinally.

One feature recently caused a return visit to the New York courts over a dust-up about  
continued on outside column of next page





# SIGHTINGS

## a-cup — cont'd

whether the boat's use of an engine to power her sailing systems violates the deed's provision that the event be sailed under the host club's rules, which — at the time of BMW Oracle's challenge — didn't include a waiver of the ISAF rules that govern such items, but have since been modified to do so. As of this writing, Alinghi's use of stored power looks as if it will be permitted. If you ask us, this is a little unfortunate. We're used to seeing advertisements from sailmakers, gear manufacturers and composite materials makers touting the use of their products by Cup teams. We don't know who built the engine or what type of fuel it uses, but can you imagine an ad from Yanmar, Mercruiser or Cummins spouting off about how their internal combus-

continued on outside column of next sightings page

## mad dogs and

Two British adventurers will be departing Inuvik, in Northwest Canada, on July 24 (as this issue goes to press) bound for Pond Inlet on Baffin Bay in the Eastern Canadian Arctic. They plan to make the 1,700-mile west-east traverse of the infamous Northwest Passage in a 17.5-ft open boat. Ken Oliver, 41, and Tony Lancashire, 35, are both career Royal Marines whose avocation is boating. The boat they'll be sailing and rowing is a specially modified Norseboat 17.5, a gaff-



*Looking good (clockwise from below) — Taking a dip aboard 'Naniloa'; 'Cheryl L.' rides the wave; "Reef? I don't need no stinkin' reef!"; the crew of 'Jelly Bean' have sweet smiles; the 'Irish Eyes' have it.*

PHOTOS PETER LYONS / LYONSMAGING.COM



## englishmen

rigged catboat built by Norseboat, Inc., of Nova Scotia. The boat has an enclosed bow, but that will be full of stores. "We can get out of the weather to sleep but not in a closed space," says Oliver. "There is room for one of us at a time to sleep in the bow of the boat under a canvas cover. When the weather precludes our sailing or rowing, if we can land safely, we will put up our tent." For more, see their website at [www.arcticmariner.org](http://www.arcticmariner.org).

— jr



## a-cup — cont'd

tion engine won the America's Cup? That would be a little strange.

In the meantime, we'll be waiting for what will likely be one of the coolest America's Cups ever, in some of the most radical boats ever designed. And we'll also be curious to see if the big black trimaran BMW Oracle has been sailing off San Diego is the boat they end up taking to the match. There's been plenty of speculation that they have another one in progress. Only time will tell.

Max Ebb takes a closer and more edified look at the cat vs. tri question this month, starting on page 122.

—rob

## sausality yacht brokers arrested

Robert 'Clay' Prescott, 65, and his wife, Teresa, 49, were arrested at the Sausalito offices of their yacht brokerage, Anchorage Brokers & Consultants (aka ABC Yachts) on July 16 and taken to the Marin County Jail. According to Deputy D.A. Linda Wong, Clay was charged with eight counts of embezzlement, three counts of writing bad checks, and two counts of embezzling from an elder or dependent adult. Teresa was charged with eight similar counts. In plain English, the Mill Valley residents have been charged with, among other things, selling boats for clients, but then not giving the clients the money due them at the end of the transaction. According to the Sausalito Police, victims claim losses estimated between \$250,000 and \$270,000. Bail was set at \$500,000 for each defendant. A deputy public defender asked that Teresa be released or at least have her bail reduced because the couple have a 17-year-old daughter. The request was denied. On July 24, she made bail but Clay was still in custody.

Authorities say they've found five victims of ABC Yachts to date, but it's unclear when the alleged criminal activity began. One Southern California customer of ABC Yachts told us that ABC sold his Sceptre 41, and the new owner, a Canadian, sent ABC Yachts a check for \$160,000 on February 25. The seller should have received a check for \$144,000 from the ABC trust account in a matter of days. Instead, the seller told us, Clay kept putting him off, promising he'd send the money shortly. On April 1, Teresa allegedly signed a check for the full amount and sent it to the seller. The much-relieved seller quickly deposited it in his checking account. On April 3 he got the bad news — the check was no good. Who knows, maybe it had only been an April Fool's Day joke.

When the seller reached Clay by phone, Prescott reportedly told him, "I'm really sorry, times are tough. We took your money." When asked where the money had gone, Prescott reportedly said, "We spent it," adding that he hoped to pay the man back over time. Indeed, on April 10, ABC sent a good check for \$5,000 to the seller. Unfortunately, that was just 3.5% of what he was supposed to receive.

On April 4, a day or so after the seller learned the first check had bounced, he called the Sausalito Police Department. "If there is one hero in this case," says the seller, "it's Sausalito Officer Sean Smagalski. Within one hour of receiving a copy of the bad check, he was in his car looking for the Prescotts. It was he who got the Marin County D.A. involved. It was he who got the Department of Boating & Waterways involved. It was he who found out there were at least four other victims, who inexplicably didn't report not getting paid for their boats. It was Officer Smagalski who put together a 700-page file on the case."

Nonetheless, it's at this point that the legal system and the state completely failed the consumer. For one thing, the state agency that regulates yacht brokers requires that a broker carry a bond worth just \$15,000 — a rather trifling sum for businesses that may hold hundreds of thousands of dollars in their trust accounts at one time, wouldn't you agree? Secondly, for a period of more than 3.5 months, neither DBW nor the Marin County D.A. did anything to close down ABC Yachts or

continued on outside column of next sightings page



# SIGHTINGS

## abc yachts — cont'd

warn consumers that they were under investigation. DBW told us that if a consumer called and specifically asked about ABC Yachts, they would be able to say only that a complaint had been filed. True, it's not quite as bad as the state taking three to five years to get around to investigating whether rogue nurses killed their patients, but we find such a delay to be unacceptable. Indeed, it's our understanding that there were additional victims after the Marin County D.A. and DBW had been made aware of the case.

After we heard of the allegations against the Prescotts and ABC

Yachts, we at *Latitude* were put into a difficult position. The last thing we wanted was to run another ad for ABC if we believed that it might lead to other customers losing their money. But with DBW and Marin County unwilling to say anything other than that they were "investigating" the situation, and with both of them allowing the Prescotts and ABC to continue operating their business, we felt our hands were tied.



LATITUDE / LADONNA

**The owners of ABC Yachts on Sausalito's Gate 5 Road are accused of taking clients' money.**

After all, without any confirmation from official agencies, we had no evidence that the seller's accusations were actually true. We believed the seller we talked to, but we had no proof. When we talked to Clay about it, he said the buyer would be paid, possibly through a payment schedule, and that it was all being taken care of. He said that if ABC was closed down, the seller would certainly never get his money. Sounds like a curious bit of extortion, doesn't it? For his part, the seller asked us to let ABC continue to run ads, saying that it was his only hope that he might see more of his money. In any event, all we felt we could do was write a *Sightings* piece about how to buy a boat, and suggest that, given the times, perhaps a trust account, separate from the broker's trust account, should be set up for boat transactions.

In June, with ABC behind in payments to *Latitude* for their ads, we pulled the plug on the company for the July issue. Clay called asking how he could get back in. We asked him to explain what had gone on. He admitted that he'd spent all the money he'd gotten for the seller's boat, and it was just plain gone. We were furious on behalf of his clients and the marine industry, and let him know it in no uncertain terms. We demanded to know what had happened to the money. When he said that it went to things like three months of house payments and business expenses, we confronted him with the fact that the numbers still didn't add up. Where the hell was the other \$100,000? Clay would only say that it was gone.

If the criminal allegations are true, the Prescotts' behavior is inexplicable to us on two counts. First, how can you just take \$145,000 or so that belongs to somebody else? We're not naïve enough to think that people don't do it. We just don't understand how they can. Second, if your business is going down the tubes, isn't it obvious that bankruptcy is a preferable option to being arrested on felony charges, and facing huge legal bills and perhaps long terms in jail? The one thing you can say about the Prescotts is that they worked their asses off for years, and continued to work as hard as they could in a very tough business environment. But you have to wonder, when they had to put on their blue jail outfits for the first time, if they realized they'd

continued on outside column of next sightings page

## ala wai harbor

On June 5, just a little over a month before the first TransPac boats were slated to arrive, Hawaii Governor Linda Lingle dedicated three new floating docks at the Ala Wai Small Boat Harbor in Honolulu. For years we've been railing against the state's apparent inability to properly manage what should be a cash cow — ridiculously low-cost slips in a fantastic location — and now they've finally stepped up.

After 30 years of neglect, much of the marina's slips were either unusable, condemned or just plain gone. Lingle's 2006 promise to turn the Ala Wai into the state's "flagship recreational harbor"



## gets a facelift

was met with understandable skepticism. But somehow she did it. With the replacement of G dock last year, and now B, C and D docks, 248 slips are finally back in service at a cost of about \$5.3 million. The 40 remaining condemned slips are scheduled to be replaced later this year.

Now, if the state would just increase slip fees from the ludicrously low \$5.25 per foot to current market levels — and put that money back into the maintenance and improvement of the marina — the Ala Wai could become a world-class yachting destination.

— *ladonna*

## abc yachts — cont'd

made some poor choices.

Despite having done business with the Prescotts for many years, we find it very difficult to drum up much sympathy given the crimes they're accused of committing. Maybe it's because we're cold-hearted. Or maybe it's because we know that damage done by such alleged crimes tends to have a broad ripple effect. On the day we last spoke with the Southern California seller by phone, he told us that he and his wife, now suddenly out nearly \$145,000, were forced to put their home up for sale. The couple's 10- and 8-year-old daughters were distraught, unable to comprehend how they could lose their home when their parents hadn't done anything wrong. The seller's wife can't sleep at night, as the loss has put strains on both the husband and wife's small businesses. All this for something that never should have happened, either to the seller or other alleged victims — or to the Prescotts.

— *richard*



*The Ala Wai Small Boat Harbor's docks looked like this (above) last July. They were replaced by new floating modular docks in time for arriving TransPac boats last month.*



# SIGHTINGS

## **sir foxy?**

Neophyte entrepreneurs could learn a valuable lesson from irreverent Caribbean crooner Foxy Callwood. Ever since opening his thatch-roofed beach bar on the tiny British Virgin island of Jost Van Dyke in the late '60s, he has been on site to greet and entertain visiting sailors day after day, year after year. That dependable consistency has made his Tamarind Bar and Restaurant a must-see destination for virtually every visitor to this idyllic British territory, which has long been the most popular yacht chartering destination in the world.

From extremely humble beginnings, Foxy, now 71, and his long-suffering Australian wife, Tessa, have slowly expanded their waterside operation to include a top-rated restaurant, a micro-brewery, a boutique, and an expansive concert venue for special events — such as

continued on outside column of next sightings page

## **cuauhtemoc scores**

Mexico may not have the most powerful military in the world, but they seem to make up for their lack of firepower with fantastic style. Having a soft spot in our hearts for tall ships, we couldn't resist the temptation to witness the arrival of the magnificent 270-ft tall ship *Cuauhtemoc* as she entered the Bay July 13 under sunny skies with festive Mexican music blasting from her loudspeakers and nearly 100 cadets straddling her yardarms. With a San Francisco fireboat ushering her in like a floating fountain,



SPREAD: STEVE LAPKIN / WWW.H2OMARK.COM; INSET: JIM CASEY



## 10 for style

the globetrotting barque sailed in with her full complement of 23 sails drawing on a light morning breeze.

Prior to crossing the North Pacific to make her landfall here, *Cuauhtemoc* spent the previous six months touring Asian ports in her dual mission as goodwill ambassador and Naval cadet training vessel. The voyage commemorated the trading route between Mexico and Asia, called Nao of China, that's been followed for more than 400 years.

continued in middle column of next sightings page



Spread, the 'Wicked' crew were all business in their quest for the top slot in the Trans Tahoe Regatta, while the crew of 'Pleiades' (inset) were a little more playful. Read all about the action in Race Sheet.



## foxy — cont'd

their notorious New Year's Eve mega-parties. In recent years they've funneled a portion of their profits into the Jost Van Dyke Preservation Society, a nonprofit they helped create that's focused on preserving the island's environment and cultural history. A key project is the construction of 32-ft Tortola sloops, modeled after the hand-hewn sailing craft used by BV islanders in generations past, and built today partially by school-age kids.

Those philanthropic efforts, and Foxy's undeniable contributions to the success of BVI tourism, have earned him a completely unexpected honor. Earlier this year, he went to England to be inducted into the prestigious Order of the British Empire by none other than Queen Elizabeth II. Don't worry, we don't have to call him Sir Foxy as the MBE is a few notches below knighthood. While his contributions certainly deserve acknowledgement, the title seems a wee bit ironic, because if we know anyone who shuns formality, it's Foxy. In fact, we're reminded of one of his classic lines: "Yacht club? Yeah, I'm a member of a yacht club, the MOFYC. (My Own F\_ \_king Yacht Club.)"

No matter how nice the Royals were to our old friend, we're absolutely certain he didn't linger long in the British Isles. Why? Because he has to wear shoes there!

— andy



LATITUDE ARCHIVES

Foxy's bawdy ballads and politically incorrect humor have made him a legend.

## high time for the ha-ha

If there is one thing we've learned in life, it's that you don't want to fight the seasons. So while we're just entering the prime time for sailing in both Northern and Southern California, it's less than three months until the days grow short and the air chilly. For those sailors not tied down by obligations, there's a one-word answer to the question of what to do with your boat at the end of October. It's called the Ha-Ha, the 750-mile cruisers' rally from San Diego to Cabo San Lucas, with R&R stops at Turtle Bay and Bahia Santa Maria.

The Ha-Ha is the gateway to a winter of cruising or commuter cruising in Mexico, where the sailing generally is easy, the air and water are warm, and the locals and other cruisers are super-friendly. With the exchange rate greater than 13-to-1, the dollar can be made to go a long way in Mexico. What about the narco gangs and swine flu? Tell someone who cruised Mexico last year that you're worried about such threats and they're likely to burst into uncontrollable laughter.

As of June 22, the Ha-Ha had received a total of 122 entries for this fall's event. We're expecting another 30 to 50 more by the September 10 deadline. It's a typical Ha-Ha fleet, meaning there are boats representing every segment of the sailing world. So far there are 23 boats under 34 feet in length, the smallest being *Little Lara*, Jay Bowden's Pacific Seacraft Dana 24 from Santa Barbara.

A total of 18 boats longer than 50 feet have signed up, the biggest being *Odysseus*, a Maxi 97 owned by two-time Ha-Ha vet William Hogarty of the Bay Area. Even the Over 50-ft Class runs the whole gamut of boats. Many are full-on cruisers, such as the CT 54s *Teal Sea* and *Chrokeva*, owned by Craig Schroeder of Long Beach and Mark Pitts of San Diego respectively. Then there are the more performance-oriented over-50-footers, including William Piper's *J/160 Pipe Dream* all the way from Miami, Jim and Diana Freeland's *Santa Cruz 52 Prufrock* from Oahu, and Bob Callaway's *MacGregor 65PH Braveheart* from Pleasant Harbor, WA.

There are 11 multihulls so far. Although Paul Marston's Corsair 31 *Sally Lightfoot* from Ventura is one of the smaller multihulls, we

continued on outside column of next sightings page



# SIGHTINGS

## ha-ha — cont'd.

know this veteran racer will be battling all the big boats for line honors. But forget the extremes; the overwhelming number of entries are racer/cruisers in the 36- to 47-ft range, with Catalina having made 13 of them. We haven't calculated the average age of the boats entered, but in years past it's been about 15 to 17 years. The sailboats built in Southern California and Taiwan in the '60s and '70s have proven to be very durable, so there will be some classic plastics pushing 40 years of age.

There are lots of reasons to enter the Ha-Ha. The discounts on goods and services in California and Mexico more than make up for the entry fee, which at just \$350 is unusually low for such a rally. There is the bountiful bag full of swag each boat gets. In addition, there are the benefits of the daily professional weather forecasts, the roll calls, and 'safety in numbers'. But if you ask the returnees — and there will be lots of them this year — what they like most about the Ha-Ha is the people they meet. Do one Ha-Ha and you can end up with friends and sailing opportunities to last you a lifetime.

The Ha-Ha is open to boats that were designed, built, and have been maintained for open-ocean sailing. There must be at least two crew with overnight sailing and navigation experience. And don't kid yourself — while the downwind sail to the Cape is usually a relatively easy one, you always have to be ready for whatever the Pacific might want to dish out.

For information on how to enter, and to see a current list of entries, visit [www.baja-haha.com](http://www.baja-haha.com). To get on the Crew List, hit the 'Crew List' button at [www.latitude38.com](http://www.latitude38.com).

We're totally into the concept of the endless summer, so *Latitude's* 63-ft cat *Profligate* will be the mothership for the 13th year, with the publisher of *Latitude* serving as the Grand Poobah, *Latitude* Managing Editor 'Banjo' Andy Turpin serving as the Assistant Poobah, and Doña 'Don't Mess With Me' de Mallorca as the Head of Security.

God knows there's been enough gloom recently, so if you're not into whining, we hope you can join us for some hot sailing fun under the Mexican winter sun.

— richard

## mob mentality

People fall off boats all the time, especially racing boats. Most are recovered quickly with little more lost than a few places in the standings. But not always. For most of the sailing demographic, MOB — 'man overboard' — is one of the most dreaded scenarios, right up there with fire or sinking. We have run many articles over the years detailing the tragic consequences of some of those incidents; occasional articles about near-miraculous rescues; and countless 'how to' articles about the best ways recover overboard crew.

We were surprised to realize recently that in all that coverage, we have given only tacit attention to the other end of the MOB pole — the person who was actually in the water. So now we want to do that, and we need your help. We're asking anyone who's ever fallen off a boat (and obviously lived to tell the tale) to write a short summary of what the experience was like. At some point in the future, we'll compile the accounts into a feature. To 'prime the pump,' so to speak, here are quickie summaries of the top three most fantastic overboard stories involving sailboats and West Coast sailors that we've come across in the last 30 years or so. (Plus the added bonus of a particularly

continued on outside column of next sightings page

## cuauhtemoc

*Cuauhtemoc* was built in Bilbao, Spain, in 1982, the last of several sisterships, including Colombia's *Gloria*, Ecuador's *Guayas*, and Venezuela's *Simon Bolivar*. Since being commissioned, she has logged more than 400,000 sea miles visiting ports throughout the world. The gleaming white ship was named for the last Aztec emperor, who was imprisoned and

*If you've got a fear of heights, the Mexican Navy is not for you. The 'Port Salute' (spread) is one of the grandest traditions among cadet training vessels. It's a test of both bravery and balance.*



LATITUDE / RICHARD



*The Ha-Ha is a heckuva good way to lose the gloom.*

## — cont'd

eventually executed by the conquistador Hernán Cortes in 1525.

While berthed at San Francisco's Pier 27, the 'Class A' vessel was toured by more than 20,000 tall ship enthusiasts of all generations. She was the first international tall ship to call on the Bay in several years.

— andy

## mob — cont'd

fantastic non-yacht incident.) Please note that yours doesn't have to be anywhere near this amazing to be part of our roundup.

• In the 1951 TransPac, the 73-ft cutter *L'Apache* was 800-some miles from Honolulu in 20 knots of breeze when she took a roll and crewman Ted Sierks went overboard. He was not wearing a lifejacket. The crew, led by sailing master Peggy Slater, threw two liferings over, one of which the fully-clothed Sierks grabbed. But by the time they got the sails down, started the engine and reversed course, 10 to 15

continued on outside column of next sightings page

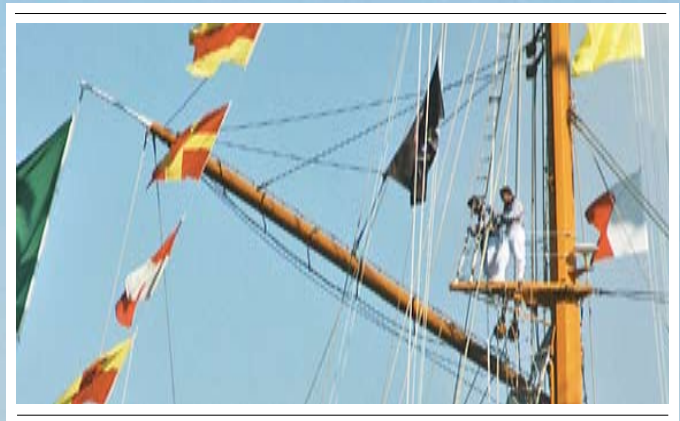



# SIGHTINGS

## mob — cont'd

minutes had passed, and they couldn't find him. What ensued was perhaps the longest and most intense search in TransPac history, joined by not only a half-dozen other TransPac boats, but a B-17 out of Hickam Field and five Destroyer Escorts. Sierks was finally located just before dusk the next day, having spent 29 hours in the water.

• In the early '60s, Slater herself famously fell off her Kettenburg 38 *Valentine* in the Molokai Channel. She was singlehanded to Hawaii and had gone forward to change a headsail during a squall when the incident occurred. Though she remained attached to the boat via jacklines and a harness, she was pinned against the side of the boat by the sail and

continued on outside column of next sightings page

## dinius trial

On July 17, supporters of Bismarck Dinius took a collective breath of relief when Lake County District Attorney Jon E. Hopkins announced in an open letter posted to the county's website that he would drop the ridiculous vehicular manslaughter charges against Dinius. But that breath turned into a groan of frustration as they finished reading the bizarre letter.

The letter, posted in the middle of jury



PHOTOS COURTESY MEERKAT

## to continue

selection for Dinius' trial, maintains that Lynn Thornton's 2006 death was caused by "drunken sailors." Dinius happened to be sitting at the tiller of a sailboat drifting along in zephyrs on Clear Lake when it was rammed at an estimated 40-50 mph by a speedboat driven by Russell Perdock, the #2 man at the Sheriff's Office.

For reasons not adequately explained in the letter, Hopkins said he would dis-

continued in middle column of next sightings page



**We were motorsailing our Ventura-based Ocean 49 catamaran 'Meerkat' into Banderas Bay when this humpback whale surfaced on our starboard side. My husband Jim had to turn the boat to stay clear of this big boy. We think he may have been trying to keep us away from a couple of mating whales, as he began herding us — we ended turning 180 degrees! He slapped his tail for about 10 minutes while we just floated there, then swam behind us and began breaching. What a show!**  
— heather stapleton donnell



## mob — cont'd

unable to get back aboard. She was in the water for 11 hours before being spotted by another boat and rescued. She later commented, "I believe I'm the only person to sail to Hawaii underwater."

• In 1993, Bill Forrest was motoring across Bahia Culebra in Costa Rica. The Bay Area sailor was alone aboard his Capo 30 *California Girl*. It was a hot morning, so he stripped off his shorts and started a bucket shower to cool off. But when he leaned against the lifelines to get a second bucket, the lifeline broke and he went into the water. He could not get ahold of the slippery boat as it went by, but managed to get a hand on a trolling line he'd rigged — only to have it slip through his grasp and have the hook impale his hand. Being towed behind the boat nearly drowned him, but he managed to be the big one that got away, eventually breaking the line. Then, treading water, he watched his boat slowly motor over the horizon and disappear. He was 68 years old, naked, bleeding and 12 miles offshore. Incredibly, Forrest managed to swim to land, coming ashore on a rocky beach in the wee hours of the following morning. It took another week of working his way south along the rugged coast before he was found.

• Bonus MOB — In July 1908, in heavy going in the North Atlantic, Seaman James Wilkinson was washed off the deck of the battleship *USS Minnesota* by a huge wave. A few minutes later, another big wave deposited him — unharmed — on the deck of the *USS Vermont*.

You swimmers out there, please include as many details as you can — year, boat, boatspeed, conditions, etc. We'd also like to know what you were wearing (particularly whether you were wearing a life-jacket or not), what was going through your mind, how long it took to get rescued, and what actions the crew took to make it happen. We'd also like to know if and how the incident might have changed your life, and your sailing attitude or those of your rescuers. Address all incidents to [ladonna@latitude38.com](mailto:ladonna@latitude38.com), subject line 'MOB'. We'd really like to make this a meaningful exercise, so the more responses the better. If you know someone with a good story who is too shy or computer-challenged to write themselves, either 'interview' them and send along their story, or give us their contact information and we'll call them ourselves. Photos are encouraged.

We will send *Latitude 38* T-shirts to all respondents whose stories are used in the article.

— jr

## gore to speak at leukemia cup

The San Francisco Leukemia Cup Regatta is just three years old, yet it's the highest grossing event in a series of 38 Leukemia Cups that run across the country. From its inception, the San Francisco edition, hosted by San Francisco YC, has been recognized as the top earner in this series of fundraisers for the Leukemia & Lymphoma Society, with last September's contributions topping more than \$663,000 — \$371,000 more than the next highest grossing regatta. Of course, competition shouldn't be the primary goal when fundraising, but we are talking about racers here — and the end result is more money for a great cause.

Belvedere's Tom Perkins has been a strong supporter of the regatta, and last year brought his magnificent 289-ft *Maltese Falcon* to the Bay, as well as inviting News Corp Chairman Rupert Murdoch to be the keynote speaker at Saturday's sold-out VIP dinner. One might think that would be a hard act to follow, but Perkins has once again raised the bar by securing yet another world-class keynote speaker for this year's event: Former Vice President Al Gore.



**Ex-Veep Al Gore will speak at the Leukemia Cup.**

continued on outside column of next sightings page



# SIGHTINGS

## gore — cont'd

Since leaving political office, Gore has been outspoken on environmental issues, writing two bestsellers — *Earth in the Balance* and *An Inconvenient Truth* — and was later the subject of an Oscar-winning documentary. He also won the 2007 Nobel Peace Prize for his work. Event organizers understandably expect that his September 19 talk — to which only those who donate or raise more than \$1,000 are invited — will be a sell-out.

For more on this year's event, to be held September 19-20, go to [www.leukemicup.org/sf](http://www.leukemicup.org/sf).

— ladonna

## can your schooner come out to play?

When you consider all the racing that happens on San Francisco Bay it's a real shame that in recent decades only the annual Master Mariners Regatta has featured big wooden classics. That's precisely why a handful of vintage schooner owners decided last year to stage an annual event of their own called The Great San Francisco Schooner Race.

After a very successful first run last summer, the event will be even bigger and better this year. Slated for Saturday, August 29, and sponsored by Belvedere's San Francisco YC, the three-day schedule includes a Friday night skippers' reception at the club, followed by a ship parade up Raccoon Strait at 11 a.m. Saturday, followed by a pursuit race at noon, starting off the Knox buoy. There'll be a post-race no-host barbecue on the clubhouse deck afterwards with live music. And the awards ceremony will feature both perpetual and 'keeper' trophies — plus free beer! Those schooner owners who raft up at the club overnight can look forward to a hearty 'Schooner Breakfast' Sunday morning.

A vast assortment of the region's finest classic beauties are expected to attend including *Santana*, *Brigadoon*, *Yankee*, *Ka'iulani*, *Seaward*, *Maramel*, *Aldebaran*, *Elizabeth Muir*, *Wanderer II*, *Contesa*, *Stardust*, *Goldstar*, *Regulas*, *Wanderer*, *Jakatan* and others. Start times will be based on the race committee's 'non-protestable' handicap system, with staggered starts based on ratings. (See [www.sfy.c.org](http://www.sfy.c.org) after August 21 for complete handicap and course details.)

It sounds like a whole lot of fun to us — and a photographer's dream. See you out there.

— andy

## short sightings

**POINT SAN PABLO** — The funky facilities and quirky ambience of Point San Pablo Yacht Harbor may be a thing of the past if a rumored sale to Chevron goes through. The big oil company, whose refineries surround the harbor on three sides, has reportedly expressed interest in buying the harbor, which is currently home to a few dozen residents and about 200 boats, many of them abandoned. If the deal goes through, the word is that Chevron intends to level the buildings, remove the docks, clean up the 27 acres — and close it off to the public as a security measure. This from the folks who for years ran those TV spots that touted, "Do people care this much? People do." Residents of Point San Pablo Yacht Harbor have formed a nonprofit organization to purchase the harbor themselves and maintain what an *SFGate.com* piece called its 'dilapidated charm.' The City of Richmond has ponied up \$6,000 to help pay for an appraisal, and the East Bay Regional

continued on outside column of next sightings page

## dinius

miss the manslaughter charge but continue with the prosecution of the felony BUI "causing bodily injury or death." That charge still lays the fault of Thornton's death solely at the feet of Dinius and could earn him three years in prison.

Hopkins also maintains that he can't prosecute Perdock because he can't prove how fast he was going. Really? Perdock himself has admitted to going 40 mph, and witnesses on shore put his speed higher. Beyond the admission of his speed, it seems to us that forensic scientists should have an easy time of estimating that piece of evidence.

In a hearing on July 21, Victor Haltom, Dinius' attorney, filed a motion alleging



Above, 'Santana' and 'Elizabeth Muir' battled it out in last year's inaugural Great San Francisco Schooner Race. Spread, 'Aldebaran' will be back this month for a repeat performance.

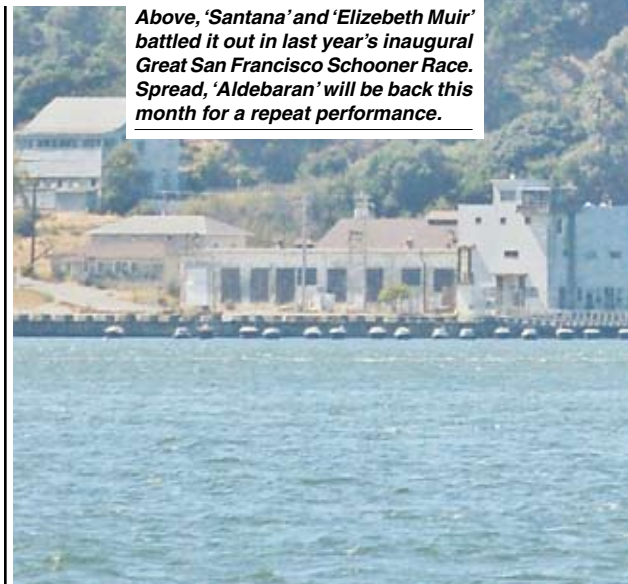

## — cont'd

prosecutorial misconduct for posting the letter online during jury selection. The judge in the case, while admonishing the D.A. for issuing the letter, did not find any misconduct on Hopkins' part. The trial is slated to begin July 28.

In the meantime, Dinius' legal bills are stacking up. You can now contribute to his defense fund through Paypal — his ID is [bismarckdinius@comcast.net](mailto:bismarckdinius@comcast.net) — or by sending checks made out to Bismarck Dinius, with "Bismarck Dinius Defense Fund" in the memo section, to Sierra Central Credit Union, Attn: Brian Foxworthy, Branch Manager, 306 N. Sunrise Ave., Roseville, CA 95661.

— ladonna

## shorts — cont'd

Park District has given \$10,000 to amend the 2004 Point San Pablo Open Space Study to include preservation of the harbor. One of the claims to fame of the harbor, located a mile east of Point San Pablo (the point just past the East Brother Lighthouse), is that it was used as one of the sets for the 1955 John Wayne movie *Blood Alley*. For years, the remains of an old steamer and other vessels sunk for the movie were visible off the harbor entrance.

**SAN FRANCISCO** — On July 17, John Cota, the pilot of the 901-ft *Cosco Busan* that sideswiped the Bay Bridge in '07, was sentenced to 10 months in federal prison, the maximum allowed under his plea agreement. Cota, 61, pleaded guilty in March to negligently causing the discharge of 53,000 gallons of oil into the Bay and to violating the Migratory Bird Treaty Act by causing the deaths of thousands of birds. Fleet Management Ltd., which owns the ship, is slated to go on trial in September on charges of negligently causing the spill and destroying evidence.

— jr & ladonna



PHOTOS LATITUDE / ANDY



# TRANSPAC 2009

There's never a guarantee that a race will produce a definitive story; some are just nondescript. They're neither the slowest, nor the fastest, the biggest, nor the smallest. But every once in awhile, an edition comes along that's destined to forever hold a place in the race's lore.

The 45th TransPac staked a place in the latter category. Not only did it produce a new elapsed time to beat — Neville Crichton's R/P 100 *Alfa Romeo* absolutely obliterated the previous record — but it also produced a new doublehanded record — Philippe Kahn and Mark Christensen took 2.5 days off the old one — and the first clean sweep in 16 years.

John Kilroy Jr.'s TP 52 *Samba Pa Ti* covered the 2,225-mile course in a mind-blowing 7d, 8h, 17m, 11s to win the 'Barn Door' trophy for the naturally aspirated boat — i.e. not using powered sailing systems or moveable ballast — with the shortest elapsed time, the overall corrected time win and the Division 1 win.

"I remember in the old days sailing the race as a kid," Kilroy said. "We used to think that if you could finish in nine days, that was incredible, and everybody had the dream that someday eight would be possible . . . It's funny to think that a 52-ft boat is the third boat to arrive in Hawaii."

In the 2007 edition, *Samba* was locked in a tight race across the Pacific with the kids on *Morning Light*. This year, they sailed the first six days of the race

stretch.

"We didn't have a strategy with regard to *Flash* so much as to just be efficient in the way we sailed," Kilroy said. "We tried to minimize our moves and we knew we had to be patient in the first half of the race because she was optimized for it, and we weren't."

*Samba*, with its more reaching-oriented hull form, was sailing in TP 52 mode, minus the internal ballast. As a result, she weighed almost 1.5 tons less than *Flash*, while retaining her oversized IRC kites.

"The configuration they chose to race in is particularly suited to the first half of the race," Kilroy said. "We chose to go with more of a downwind mode. As the race wore on, we knew we'd be able to pull away."

"I look at any victory as a team victory," Kilroy said of his team, which included navigator Nick White, Bob Wylie, Robbie Naismith, Justin Ferris, Mikey Joubert, longtime boat captain Eric Arndt and watch captain Stu Bannatyne — who in addition to being fresh off winning the Volvo Ocean Race aboard *Ericsson 4*, had put together the crew for *Alfa Romeo*. "We've all sailed together as a team, for a long time. These are all seriously good sailors. We're all really good friends and we all know each other's capabilities."

That continuity was probably the one thing *Flash* lacked. A late-starting project, the boat was

configured with a heavier bulb, deeper keel fin and square-top main, not just for TransPac, but for an inshore series of races in the coming year.

The crew, which included Paul Cayard, his son Danny and daughter Allie, Jay Crum and his son Joe, Will Paxton, Hogan Beatie, Paul Allen, Skip McCormack and Akin,

was plenty long on talent but short on time together. Yet Akin was nonetheless pleased with *Flash*'s second overall, second in Division 1 and having one of the top-10 fastest elapsed times for a



**Chip Megeath's 'Criminal Mischief' blasts by the Diamond Head buoy.**

conventionally-ballasted monohull in the race.

"I never imagined that we'd have been in striking distance for so long, or that we'd do this well," Akin said.

Overall winner of the '06 Pacific Cup aboard his SC 52 *Lightning* with *Flash* project manager Jeff Thorpe — who navigated Chip Megeath's Division 3-winning R/P 45 *Criminal Mischief* this year — Akin may have been pleased with both the TP 52 and his crew's performance, but the difference in accommodations was a little less appealing.

"I spent the race looking for a creature comfort," he joked. "Not creature comforts, just a creature comfort."

Another key difference between the two efforts was crew numbers. In 2007 *Samba* sailed with 10, the same number that *Flash* sailed with this year. But this time *Samba* sailed with only eight.

"It basically boils down to how many people you need to jibe the boat," Bannatyne said. "With the bowsprit instead



**John Kilroy Jr.'s (left) 'Samba Pa Ti' sailed to a clean sweep, winning the Barn Door for the fastest elapsed time for a conventionally-ballasted boat, plus division and overall wins with the help of Watch Captain Stu Bannatyne.**

in lock-step with another TP 52, Tom Akin's Bay Area-based *Flash*. Although *Samba* led *Flash* boat-for-boat the entire way, the latter held a corrected-time lead of about two hours during that six-day



# — THE FAST AND THE FURIOUS

ALL PHOTOS LATITUDE / ROB UNLESS NOTED



rig to a new TransPac record of 5d, 14h, 36m, 20s. To put that in perspective, the existing record, set by Hasso Platner's MaxZ 86 *Morning Glory* in 2005 was just over a day slower! Although 2005 was not a very fast year — the write-up in *Latitude* said, "Imagine if there had actually been any wind" — we never expected to see *Alfa* break the record by such a large margin. In fact, the boat's time was so fast, there was a chance up until very late in their race, that *Alfa* could also break the multihull record set in 1999 by Bruno Peyron's *Commodore Explorer* at 5d, 9h, 14m, 36m, 20s.

For *Alfa* and the rest of the June 5 starters, the weather could have been better, but not by much.

"The race had the nice property that it never had a slow day," Honey said. In fact, *Alfa* set a new daily-run record on the race's second day, surpassing *Morning Glory's* 2005 mark of 393 miles, by an additional seven miles. And they didn't stop there, posting a string of 400-420-431-391-mile days. Compared to Divisions 3-7 which had all started with the high squarely in their path, the big boats had a much more direct course.

of the pole, eight is pretty much all you need."

**W**hen asked at what point he first thought *Alfa Romeo* had a chance at setting a new elapsed-time record for

TransPac, navigator Stan Honey, who's sailed the race 15 times, said, "About three days before the race started."

The crowd that had assembled at Waikiki YC for *Alfa's* post-race press conference just laughed.

But knowing even just a fraction of the content of Honey's sailing resume means you know how many records the guy has broken, and we don't doubt him.

After all, he had just navigated the silver-hulled sliver with the 145-ft tall

***Peter Tong's 'OEX' crew sailed the SC 70 hard enough to do this to their vang ram.***





# TRANSPAC 2009

"It wasn't a particularly northerly race," Honey said. "Relative to the earlier starters it was, but relative to history it was kind of medium. We crossed 130°W at 28°N and I've crossed it as far north as 30°N before."

In addition to Honey and Crichton, the *Alfa* crew was like a who's who of the professional sailing world. In addition to three-time Olympic Gold Medallist Ben Ainslie, there were a handful of the guys, including Dave Endean and Tony Mutter — with whom Honey had won the Volvo Ocean Race in 2005-2006 aboard *ABN-AMRO 1* — who had just finished winning this year's Volvo aboard *Ericsson 4* before jumping on a plane to make the start.

"Compared to a Volvo, the TransPac is a walk in the park," Honey said. "It's got to be one of the most pleasant races in the world. It's one of the few races in sailing where you enjoy it *during* the race, as opposed to most races where you enjoy having *done* it. It's definitely not a Hobart or a Fastnet, where you're thinking, 'Why am I here?'"

It was the second TransPac for Crichton. His first came in the dreadfully slow 1979 race, when it took his two-tonner *Aun I Mara* 14 days to make the crossing. This time around, he went to work trying to get some of the other big maxis to come play too. We asked the now-Australia-based Kiwi — who had previously spent nine years living in Hawaii — if there were any other super maxis interested in the race.

"There was interest," he said. "When we originally got them to change the rules to allow the 100-footers with powered sailing systems in the race, Bob Oatley [the Australian who's near-sistership *Wild Oats XI*, has won four- consecutive



SHARON GREEN / WWW.ULTIMATESAILING.COM

**Tom Holthus' J/145 'Bad Pak' smokin' toward a sunrise finish off Diamond Head.**

couple other people's minds. The circuit for these boats is really in the Med. But it's one of the great races. We thought we'd like to win it. It looks good on the resume."

**E**lsewhere in Division 1, Philippe Kahn and Mark Christensen smashed

in only 7d, 18h, 38m, 35s. But it wasn't without some serious issues. Just before the start, the electrical system that cants the boat's keel and raises and lowers its daggerboards malfunctioned. In the 50 minutes they had left to go before the start, they were able to get it going again, but that wouldn't be the last they'd hear from it.

After six days of fast and wet sailing, their seventh day began with a series of 30-knot squalls and lots of fast and wet sailing. At 5 p.m. on June 12, they lost all electrical power.



**Kenny Cooper borrows some of John Shampain's hair for a Shampain-like beard. Jack Taylor (red hat) and the rest of 'Horizon' gang won Div. 5; right, Erik Shampain and Tim Fuller won Div. 6.**

line honors in the Rolex Sydney-Hobart Race] was going to come, but he changed his mind. I think the economy changed a

the existing doublehanded race record by over 2.5 days. They sailed Kahn's Open 50 *Pegasus 50* to Diamond Head





# — THE FAST AND THE FURIOUS



"There was a smell of an electrical fire, so we got the extinguishers out," Kahn reported on his blog. "Nothing worse than a fire on a boat."

They continued to sail at full throttle toward Honolulu and began troubleshooting to find the source of the problem.

In the meantime, their navigation

**So 'Flash' — (clockwise from top left) Hogan Beatie, Paul Cayard, Danny Cayard, Joe Crum, Will Paxton, Paul Allen, Jay Crum, Skip McCormack, Tom Akin and Allie Cayard.**



**Alejandro Perez Calzada, here with daughter Ana, used the race as a leg of his 'round-the-world' campaign to hit all the great ocean races.**

and communication options were dwindling.

"One emergency sat phone working," Kahn wrote. "Sailing fast. Using the Braille method!"

All night, *Pegasus* continued hammering along through the squalls and the darkness. By midnight they were down to flashlights, the analog compass and Kahn's iPhone with its MotionX-GPS application — that he wrote — to get them to Honolulu.

Finally, at about 2 a.m., the pair were able to partially charge the batteries with a temporary fix. They continued to hand steer, and managed to gain just enough power throughout the final day to cant the keel through three more jibes to finish the race.

After such a harrowing ordeal, we'd think that maybe you'd want to take a couple days off. Not Kahn — he was out for a 505 session off Diamond Head the following evening, training for the class' Worlds which are coming up this month on the Bay.

**B**ack in 1993, John DeLaura's SC 70 *Silver Bullet* was the last boat to sail to a clean sweep in the race.

This year, the boat was back, this time as *OEX* in the hands of Peter Tong, who'd

campaign a different SC 70 known as *Orient Express* back in the sleds' heyday.

And this year, the class was back also — with eight of what are some of the race's most iconic boats comprising Division 2 — after a diaspora that saw them spread out across the country in the mid- to late-90s.

"I'm crazy about the boat," said Tong after sailing in his fifth TransPac following a 12-year hiatus. Many of his crew, which included navigator Joe Buck, Bobby Frazier, Pete Frazier, Randy Smith, Gary Weisman, Doug McLean, Chuck Clay, John Sangmeister, Jib Kelly, and Jim McLeod, have sailed with him for years.

"Our crew was a lot of good, old friends," he said. "The boat is really tranquil. There's no yelling and screaming. Everybody worked hard, and on every watch change. Good information got passed on to the next shift. We knew it was close and just had the attitude that every second counted."

Tong said that past experience has taught him some important lessons about the final section of the course.

"I've done this thing a few times and it seemed like the guy to the north of us always had the leverage at the end," he said. "So we made the decision to not let anybody get leverage to the north of us in the last 600 miles."

The strategy paid off, as *OEX* vaulted into the lead, despite bending its hydraulic vang ram. When the rest of the class finished, Tong's boat had won the division by just over an hour. Perhaps most importantly, no one could legitimately complain about the ratings, thanks to





# TRANSPAC 2009

the work of US Sailing's rating office.

"US Sailing came to us and said, 'We know you're going to race together and that there are questions about the certificates. We're willing to fly out to the West Coast and remeasure all the participants,'" Tong said. "They charged a nominal flat fee, brought in two measurers and a certified scale, and organized a crane. This is the first time since the IOR days that we're racing against each other under their supervised measurements. No one can dispute any of the data."

As the IOR faded away in the early '90s, and the race's rating limit was bumped ever higher, many of the boats were modified in various ways, and, until this race, much of the rating work was performance-based.

"I would still like to sail boat-for-boat," Tong said. "But we've got what we've got now."

Still, Tong expressed his enthusiasm for the class' revival on the West Coast.

"The old cast of characters got reshuffled," he said. "But where in the world can you find something that was really good 20-something years ago, and bring it all back?"



Alfa's Murray Spence, Stan Honey and Neville Crichton.

After their July 2 start, Chip Megeath's Tiburon-based R/P 45 *Criminal Mischief* dove south immediately, making only 166 miles down the course in the first 24 hours of its race.

"We started rationing on the second day," said the Criminals' 'consigliere' Joe Penrod. "We didn't really start eating until we got into the breeze."

Navigator Thorpe from the Quantum San Francisco loft guided the 'Criminals' — Penrod, Cameron Biehl, Morgan Gutnekunst, Campbell Rivers, Robin Jeffers, Pat Whitmarsh and Ty Reed — down as far south as the latitude of Mag Bay before finally hanging a right and hooking into the pressure.

Meanwhile, their competition, namely Bob and Rob Barton's Bay Area-based Andrews 56 *Cipango*, was sailing a more direct route, well to the north, and making good time.

"You have no idea how stressful that was," Thorpe said. "I knew the high wasn't going to dissipate, but those guys still had wind."

But the southerly

route, for all its heartburn, allowed the 'Criminals' to put up some phenomenal days. On Day 5, they made 293 miles. They followed that up on Day 6 with a run of 315 miles. The next day they put up 313 miles. The day after that, they put up 330.

"I don't think any 45-ft boat has ever put together a string of days like that," Megeath said.

It might have been fun, but even on what the sailors called a "driver's boat," it wasn't without some casualties — namely both the boat's laptops.

"I had to navigate the last two days with a handheld GPS and a paper chart," Thorpe said.

Having beaten *Cipango* by some 15 hours on corrected time, Megeath and Thorpe extended their streak of division wins in Hawaii races to three straight after winning the SC 52 division with the chartered *Kokopelli* in 2007 and winning their division with *Criminal Mischief* in the '08 Pacific Cup.

Megeath, who's known to his young crew as "Dr. Megadeath," said that he's not done with the race or the boat.

"The boat has a way of finding its own way through the waves," a fired-up Megeath said. "You basically maintain the angle of heel, and God and the waves do the rest. I'll be doing this as long as I physically can."

TransPac rookie Tom Holthus and his J/145 *Bad Pak* came out on top at the very end of the race in a division that saw four of its eight boats lead at various



SHARON GREEN / WWW.ULTIMATESAILING.COM



SHARON GREEN / WWW.ULTIMATESAILING.COM

# — THE FAST AND THE FURIOUS



Philippe Kahn and Mark Christensen shaved over 2.5 days off the doublehanded record.

points. In fact, Division 4 was so tight that the next five boats finished within 1.5 hours of each other on corrected time.

"I gotta give the credit to our navigator," Holthus said of Scott Lowry. "We jibed north two days out. He said that that's where we'd have a better angle for the finish."

The move dropped them to third place temporarily.

"As the skipper, I was wondering, 'Man, is this the right thing to do?'" he said. "But I bit my tongue. I didn't want to give him any doubt. He called a great race."

While many boats had breakages of various sorts during the race, according to Holthus, many of *Bad Pak's* happened before the race even started.

"We had to rebuild the rudder and sort some computer issues before we even left," he said.

Nonetheless, the boat was ready to go the distance.

"We were pushing the boat to the limit," Holthus said. "The crew did a great job sailing the boat and we were fortunate in that everything went the way we wanted it to."

As tough a call as their jab north was, it was made even more so because one of the frontrunners, Tom Garnier's *J/125 Reinrag2* was the defending overall winner.

"*Reinrag2* is a really well-sailed boat," Holthus said. "Between the crew work, navigation, boat preparation and condi-

## DIVISION 1 (Started July 5)

1	1	<i>Samba Pa Ti</i>	TP 52	John Kilroy Jr.	176:17:11	127:52:20
2	2	<i>Flash</i>	TP 52	Tom Akin	182:42:40	129:22:22
10	3	<i>Valkyrie</i>	TP 52	Andy Rasdal	201:01:13	146:15:33
11	4	<i>Medicine Man</i>	Andrews 63	Bob Lane	182:03:09	148:12:17
12	5	<i>Akela</i>	R/P 78	Bill Turpin	179:58:10	150:00:52
13	6	<i>Cazador</i>	TP 52	Ernie Pennell	207:06:23	150:27:27
15	7	<i>Pegasus 50</i>	Open 50	Philippe Kahn	186:38:35	153:38:35
16	8	<i>Alfa Romeo</i>	R/P 100	Neville Crichton	134:36:20	155:41:13
18	9	<i>Magnitude 80</i>	Andrews 80	Doug Baker	160:17:41	157:38:48

## DIVISION 2 (Started July 5)

3	1	<i>OEX</i>	SC 70	Peter Tong	187:23:22	132:30:34
4	2	<i>Grand Illusion</i>	SC 70	James McDowell	197:11:00	133:24:43
5	3	<i>Pyewacket</i>	SC 70	Roy Pat Disney	194:13:11	135:26:08
6	4	<i>Alchemy</i>	Andrews 68	Per Peterson	199:00:45	138:44:21
7	5	<i>Mirage</i>	SC 70	Scott Abrams	202:35:41	141:22:58
8	6	<i>Ragtime</i>	Spencer 65	Chris Welsh	210:19:34	141:42:16
9	7	<i>Holua</i>	SC 70	Brack Duker	204:57:02	144:30:05
14	8	<i>Westerly</i>	SC 70	Thomas Hogan	212:37:23	151:30:55

## DIVISION 3 (Started July 2)

17	1	<i>Criminal Mischief</i>	R/P 45	Chip Megeath	224:40:00	156:37:46
27	2	<i>Cipango</i>	Andrews 56	Bob & Rob Barton	256:41:37	171:59:21
28	3	<i>Bengal 7</i>	Ohashi 46	Dr. Yoshihiko Murase	246:47:00	172:07:59
31	4	<i>Wasabi</i>	Farr 46	Jorge Ripstein	262:17:41	179:08:52
35	5	<i>Leglus</i>	Ohashi 52	Norikazu Hatsukano	263:19:49	190:12:29
36	6	<i>Free Range Chicken</i>	Perry 59	Bruce Anderson	280:01:10	195:07:51

## DIVISION 4 (Started July 2)

19	1	<i>Bad Pak</i>	J/145	Tom Holthus	260:14:24	166:11:12
21	2	<i>Reinrag2</i>	J/125	Tom Garnier	259:22:26	169:35:41
22	3	<i>Tachyon III</i>	SC 52	Kazumasa Nishioka	257:33:24	170:09:58
23	4	<i>Relentless 52</i>	SC 52	Viggo Torbensen	258:35:38	170:27:35
24	5	<i>Ruahatu</i>	Concordia 47	Ricardo Brockmann	262:07:07	170:49:42
25	6	<i>Hula</i>	SC 52	Maury Myers	259:24:02	171:06:40
30	7	<i>Artemis</i>	Andrews 53	Louis Bianco	270:20:45	176:07:33
33	8	<i>Paranoia</i>	SC 52	Rick von Heydenreich	274:23:47	180:00:43

## DIVISION 5 (Started July 2)

20	1	<i>Horizon</i>	SC 50	Jack Taylor	263:15:02	169:21:36
26	2	<i>Allure</i>	SC 50	William McClure	263:13:57	171:33:02
29	3	<i>Mighty Tongaroa</i>	SC 50	Gordon Leon	271:35:29	175:14:58
32	4	<i>Passion</i>	SC 50	Steve Hastings	268:08:13	179:16:03
34	5	<i>Roy's Chasch Mer</i>	SC 50	Gib Black	283:21:56	186:38:51

## DIVISION 6 (Started June 29)

37	1	<i>Relentless</i>	1D 35	Tim Fuller	320:16:50	206:40:36
39	2	<i>Bloodhound</i>	Hobie 33	Reed Bernhard	364:52:13	226:42:43
40	3	<i>Narrow Escape</i>	Fast 40	Doug Backhouse	344:47:01	229:31:11
42	4	<i>Addiction</i>	J/35	Linsdsey Austin	393:07:04	239:53:17
rd.		<i>J/World</i>	J/120	Wayne Zittel	Retired	

## DIVISION 7 (Started June 29)

38	1	<i>Charisma</i>	S&S 57	Alejandro Perez Calzada	340:31:56	221:36:29
41	2	<i>Between The Sheets</i>	Jeanneau 50	Ross Pearlman	360:52:06	232:48:20
43	3	<i>Far Niente</i>	Catalina 42	Patrick Hearne	406:07:09	250:31:11
44	4	<i>Hassle</i>	Catalina 38	Larry Malmberg	427:26:39	254:48:18
45	5	<i>Lynx</i>	Tallship 78	Jeffrey Woods	418:49:52	292:04:20
rd.		<i>Silent Running</i>	Jeanneau 45	Bruce Orisek	Retired	

tions — the swell was never big enough to really let the SC 52s surf — we were really fortunate."

A division win has got to be gratifying, and even more so if you do it in style. *Bad Pak* and her crew, which included Charles Jenkins, Tom Deere, Ryan Castro, Andrew O'Dwyer, Brian Johnson and Jimmy Richardson, finished the race just after sunrise.

"It was gorgeous," Holthus said. "The sun was just coming up as we were going past Diamond Head. We couldn't have timed the finish better."

Division 5, the division of the SC 50s, featured five of the boats, including hull number one — Gib Black's *Roy's Chasch Mer*. But it was Jack Taylor and his crew on *Horizon* that dug the furthest south in the opening days of the race. When the pressure finally filled and they turned the corner for Hawaii, the Dana Point-based boat hooked into an epic battle with William McClure's *Allure*.

"I love going offshore," Taylor said. This is his third TransPac with the boat



# TRANSPAC 2009

and he's also sailed it in a Vic-Maui. Somewhere in between he's managed to squeeze in Mexican races, including a division win in this year's Cabo race.

From the get-go, *Horizon's* southerly position put them down in the skeds.

"*Allure* was 60 to 70 miles north of us at the most," Taylor said. "They gained 25 miles on us one day."

"It was a little hard coming up to the crew every morning for the first couple days," said navigator John Shampain. "But we did the same thing two years ago, so they were pretty used to it. If you want to see your name in bright lights, you go north to begin with. But history says that if you're winning on day one or two, you don't win the race. I don't know if it's ever worked out for me to go north."

"Days four through seven were good days," Shampain added. "If we weren't picking up miles, we were picking up position."

As the two boats sailed down the Molokai Channel within spitting distance of each other, they pushed and pushed with *Allure* finishing just a minute and



**Richmond YC and PYSF product Chris Trezzo sailed his first T-Pac on 'Free Range Chicken.'**

five seconds ahead. Because the 1,000-lb. lighter *Allure* owed *Horizon* some two hours on corrected time, Taylor and his crew, which also included Kenny Cooper, John Taylor, Gene Batalia, Clancy

Salway, Tom O'Keefe and Scott Taylor, took the division win.

**T**im Fuller and Erik Shampain — son of *Horizon* navigator John — won Division 6 in Fuller's 1D 35 *Relentless* by more than 20 hours — doublehanded — having sailed the farthest south of any boat. The duo sailed as far south as the latitude of La Paz before making a right turn.

"We knew we had to be there," Fuller said. "At that point it was just a matter of pushing the boat."

"Being quicker than the guys in our class was an advantage," Shampain said. "It let us get south and into the pressure sooner."

This was the pair's second doublehanded effort at the race; their first came in 2007 aboard Fuller's old J/100 *Brilliant*.

"Now that we've done this twice, we've got the routine down pretty well," Fuller said, laughing. "I steer the boat and Erik does everything else."

"Every maneuver is a sequence of

## ELLIOTT / PATTISON SAILMAKERS

### Because your sail matters!



**Antrim 40 "XL" - 1st in Class Crewed Farallones**  
**949 645-6697**

LA Harbor Area:  
 Steve Dair 310 619-7245

Marina Del Rey:  
 Doug Johnstone  
 310 528-2146

Oceanside: Lee Pryor  
 760 529-0062

Photo by:  
 Charlie Bergstedt



**We have a passion for building sails. Call us about your next set.**

**870 Production Place**  
 (949) 645-6697

**Newport Beach, CA 92663**

## HI PERFORMANCE LIGHTING FOR THE OPEN SEAS

**Brighter Than Conventional Lighting**  
**Performance In Excess of 50,000 Hours**



9 - 36VDC  
 Built-in Dimmer  
 White & Red in one  
 Only 3/4 inch thick  
 NEMA 4



**UPGRADE YOUR BOATS INTERIOR LIGHTING SYSTEM!**

New GEN 5 full spectrum LED fixtures offers beautiful rich light that rivals halogens in both output and CRI.

**LUNASEA**  
**LIGHTING**



1.800.272.0170 www.lunasea.com



# — THE FAST AND THE FURIOUS

events that goes bang-bang-bang," Shampain said. "As long as you stick to the sequence, everything goes pretty smoothly."

According to Fuller, they didn't do anything to make the boat easier to sail, with their only concession to boathandling being a huge set of ears on the tiller.

"The intention was to optimize speed, not make it easier to sail doublehanded," Fuller said.

To that end they added bigger, asymmetrical, kites, a bowsprit and a square-top main — Fuller said they weren't using most of the main the whole way down the Molokai Channel.

"We took our 4A kite down to check halyard wear, took the drop a little too casually, shrimped it and poked a hole in it," Fuller said. "A squall came in from behind us and it was a melee trying to even get the kite back aboard at that point. We didn't repair it. We just put the 2A up. Only God was going to take that sail down. . . It was pretty wild in the channel."

Fuller — who's been sailing this race

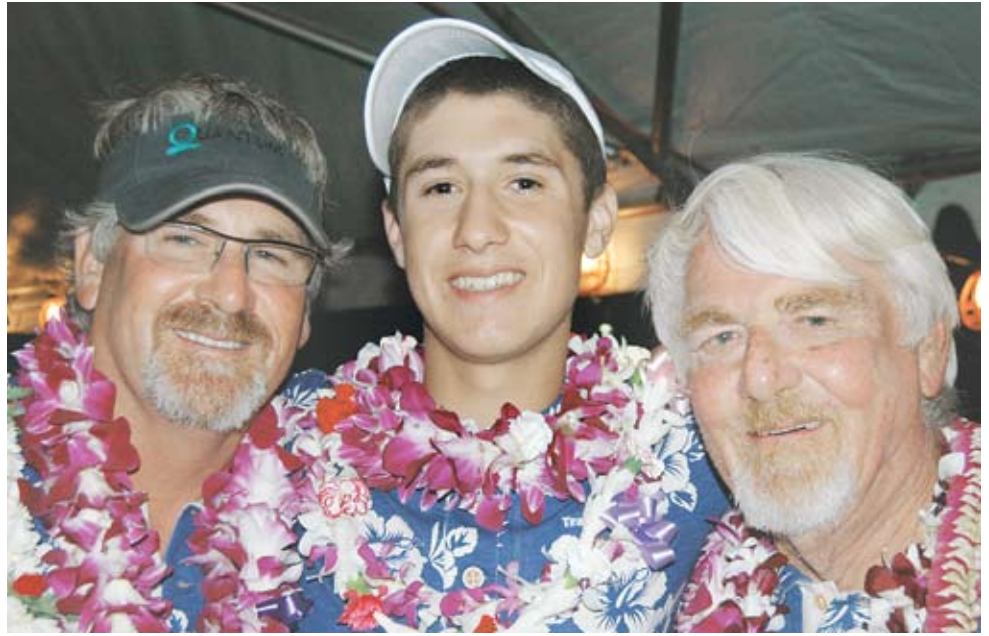

since the early 80s on everything from one-tonners to sleds — said this was his last doublehanded effort but a good one to go out on, having finished second in the doublehanded subdivision to Pega-

**Three generations of Bartons: Rob, Ted and Bob took second in Div. 3 on 'Cipango.'**

sus.

"We didn't know each other at all before the last one, but we've obviously gotten to know each other well since," Fuller said. "The benefit for me is that



"The World Leader in  
Outfitting Performance Sailors."

BLOG

THE RACK

SEARCH

Apparel

Line

Hardware

One Design Parts

Accessories

Team Gear



www.APSLTD.com

800.729.9767



# TRANSPAC 2009

Erik is just a great sailor and also goofy enough to make it fun the whole time." "Goofy is fast," Shampain said.

It's tough to argue with that when you win your division by such a large margin.

In Division 7, Alejandro Perez de Calzada had an impressive string of event flags flying from the headstay of his S&S 57 *Charisma*. With the boat having already sailed the 2006 Middle Sea Race and 2007 Fastnet Race, the Transpac was just one leg of a wrong-way circumnavigation that will see *Charisma* sail some of the world's great ocean races.

Lacking the ability to plane, they stayed fairly far north between their competition and the Islands, using their waterline to gradually grind away from the rest of the division, which featured only displacement boats, including the 78-ft tallship *Lynx*.

So where to next? The race's fleet of 47 boats was really impressive given



**'Criminals' Cameron Biehl, Morgan Gutenkunst and Ty Reed couldn't wait for their first beer.**

the current state of the economy. Could there be more 100-footer efforts in the offing?

"It's a little perilous to hang the future of the race on appealing to the super high-end grand-prix 100-footers," Said Stan Honey. "TransPac is one of the most prestigious and oldest ocean races in the

world, but it's not really on that circuit. I think it's great that Neville took a run at it. But he tried hard and wasn't able to get the other 100-ft maxis to come. So I think TransPac needs to pay attention to its roots, and in particular continue to run a first-class event. If they do that, it doesn't matter what happens to the economy — in another 100 years it will still be around."

— **latitude**/rg

## Own a dock on San Francisco Bay! Perfect Location - Great Investment

**40' monthly rent \$342** (Just dredged)

**EMERY COVE**  
YACHT HARBOR

**BUY A SLIP** – Save money & earn equity! Save 1/3 of your rental cost. Enjoy big tax savings as a slip owner. Emery Cove Yacht Harbor is the only marina on the Bay with FEE SIMPLE (not a grounds lease) dockminium ownership.

**OR RENT A SLIP** – 35-60' slips, rates from \$8.55 to \$9.55.

**MARINA GUARD®** – cutting edge electrical ground fault monitoring system.

Michael Wiest Yacht Sales  
& Emeryville Yacht Club  
on premises

Certified CLEAN MARINA

**CALL FOR A MARKETING PACKAGE • 510-428-0505**  
3300 Powell Street, Emeryville, CA 94608 • [www.emerycove.com](http://www.emerycove.com) • Email: [info@emerycove.com](mailto:info@emerycove.com)



## Ballenger Spar Systems, Inc.

Custom Racing and Cruising Spars  
Expert Design and Consultation

- Carbon and Aluminum spars
- Rod and wire rigging
- Hi-tech and conventional halyards
- Spar kits, extrusion
- Repair and modification
- Custom fabrication, waterjet and CNC
- Hardware, sheaves, spreaders
- Bay Area pick-up and delivery
- *Discounts* on halyards, standing rigging, deck hardware, furlers, Navtec integral cylinders
- 35 years experience!

Call about Carbon Spars.  
Masts • Booms • Poles

[www.ballengerspars.com](http://www.ballengerspars.com)

831/763-1196

831/763-1198 (fax)

## TransPac Victories

Congratulations to stellar performances  
by Hansen Rigging customers!

*Samba Pa Ti* 1st, Div. 1, 1st in Fleet  
*Flash* 2nd, Div. 1, 2nd in Fleet  
*Criminal Mischief* 1st, Div. 3, 2nd to Finish



CRIMINAL MISCHIEF



Dynex Dux Ultra High Performance  
Ropes with Alpha Rope V-Skin Cover  
*No Stretch! / No Burn!*

# HANSEN RIGGING

2307 Blanding Ave., Alameda  
(510) 521-7027

[hansenrig@sbcglobal.net](mailto:hansenrig@sbcglobal.net)

[www.hansenrigging.com](http://www.hansenrigging.com)

**REPAIR  
REPAIR  
REPAIR**

**ROOSTER SAILS  
A REPAIR LOFT**

**NOW AT  
GRAND  
MARINA**

**YOUR ROLLER  
FURLER UV COVER  
SPECIALIST**

**ROOSTER SAILS**

2021 Alaska Packer Place, Box 18, Alameda  
**(510) 523-1977**

[www.roostersails.com](http://www.roostersails.com) • [rui@roostersails.com](mailto:rui@roostersails.com)

Open M-Th 9-6 • Fri 9-5 • Sat by appt.

Owned and Operated by Rui Luis • Experienced Sail Repair and Fabrication

**NOW OFFERING NEW CRUISING SAILS!**

SAIL REPAIR SPECIALISTS • COMPETITIVE RATES • RECUTS • CONVERSIONS





# DELTA DOO DAH

Visions of heat waves and water fights bumped those of dancing sugar plums clean out of our heads last December when we came up with the idea for a new week-long rally from the Bay to the Delta. Over a few bottles of wine at our company Christmas party, the details were hashed out and the Delta Doo Dah was born.

Originally, the plan was to have organized events at different locations every night in an effort to cover as many of the Delta's 1,000 miles of waterway as possible. But that rather ambitious concept was quickly scrapped in favor of one that was as laid back as the region itself: A kick-off dinner, a BBQ, and a final party, with a few free days thrown in to explore or simply laze about. The entry fee was kept low — a very reasonable \$49 — and would include a burgee, T-shirt and swag bag. To keep this first year manageable while the bugs were worked out, the entry list was limited to 30 boats.

We were sure that Bay sailors would embrace the event but we had no idea the response would be so tremendous. Within two days of our announcing the Doo Dah in *'Lectronic Latitude*, all 30 spots had been filled and a waiting list was started. Now the pressure was on to host a truly kick-ass affair!

On Friday, June 26, Doo Dah'ers descended on Richmond YC — some by boat, others by car — to check in, claim their swag, grab some grub from the galley, and get to know each other. The fleet set off the next morning to ride what was supposed to have been the start of a flood tide. Unfortunately, a slight — heh hem — miscalculation by the rally committee meant most of the fleet bucked the end of the ebb before a favorable current caught up with them.

"I've been coming up to the Delta for years," said Doo Dah'er Doug Thorne, who sailed with his wife Tamara and kids Taylor, 16, and Max, 12, aboard their San Francisco-based *Celestial 48 Tamara Lee Ann*. "I always try to calculate the current carefully but only get it right about half the time."



**Taylor and Tamara Thorne enjoyed some deep daughter-mom talks.**

It was slow going for those who tried to sail in the day's light breeze, so they were spared the bombing blitz faster



ALL PHOTOS LATITUDE / DOODETTE LADONNA UNLESS NOTED

boats received when they reached Benicia, homeport to Ruben and Robbie Gabriel's Newport 30 *Windsome Wench*. "We waited for everyone to show up, then yelled 'Welcome to Benicia' and pelted them with water balloons," laughed Robbie. "We only got a few glares."

"It actually felt great," claimed fellow organizer Christine 'Doodette' Weaver, who caught one to the neck.

The majority of the fleet ended up in Antioch Marina Saturday night, with

the rest scattered between Benicia and Middle Slough. "Instead of playing on the internet that night," said Tamara Thorne, "my teenage daughter sat on deck with me. We looked at the stars and had an actual conversation."

Everyone knew Sunday was going to be a scorcher when the thermometer read 80° at 8 a.m. In Middle Slough, where 10 Doo Dah boats had anchored, the morning was spent cooling off in the water. By the time all the stragglers meandered into Antioch Marina for the afternoon BBQ, the thermometer was



# — A FIRST TIME FOR EVERYTHING



JAY HICKMAN

JAY HICKMAN

**Doin' the Dah** — Top row (l to r): Kathe Hashimoto of 'Tamara' strikes a pose — just before getting blasted by a water cannon; Patti Boucher of 'Carlos' won't let a couple boat bites get her down; 'Bucket Boy' Aaron Dunlap is a real crack-up; Robert Walker is keeping his Traveller 32 'Grace' at Bethel Island for the summer; 'Kalona's crew Chris Almuquist was a force to be reckoned with when armed. 2nd row: Jay Hickman's crew Maceo went walkabout for 24 hours in Richmond, delaying 'Moor'ea's departure; a couple dozen Doo Dah'ers cooled off in Antioch with a sunset cruise and wine tasting; why 'Broken Rudder Slough' got its name. 3rd row: Scurvy pirates Rich, Leslie, Greig, Ari, Robert, Chris and Pat prepare to defend 'Doggone'; Queen Lucie Mewes will be next year's official morning net controller; Peter Yates shuttled the fleet to the beach party aboard his ex-Army bridge erector; the Brown Family led the way in atomic yellow Doo Dah T-shirts on their Beneteau 393 'Oxygen'.



reading triple digits, and everyone was swimming between boats or hiding out in the air conditioned bathrooms.

"In a way, you're all lucky," one marina tenant insisted. "A cold wind usually howls through here." He was last spotted running from a balloon-wielding mob.

The BBQ, hosted by the marina, featured melt-in-your-mouth tri-tips, chicken, potluck dishes, and the rockin' sounds of the Romano Marchetti Orchestra, brought in by Twin Rivers Marine Insurance. Though everyone had a great time, the party was a bittersweet occa-

sion, as it also marked the retirement of well-respected Harbormaster John Cruger-Hansen.

The day was topped off by a sunset cruise aboard Delta Discovery Cruise's *Island Serenade*. Heather and Steve Ingram — who hope to join the event next year aboard their Ranger 33 — welcomed a couple dozen Doo Dah'ers aboard with snacks, a generous wine tasting courtesy of Carvalho Winery and, of course, air conditioning.

"I can't believe more people didn't come," said Kathe Hashimoto of the Sausalito-based OL 33 *Tamara*. "This is really the perfect way to end the day."

Those who weren't too impaired by the previous night's wine tasting — and post-wine tasting nightcaps — left Monday morning for the next rendezvous point: The Rusty Porthole on Bethel Island.

**B**ethel resident Peter Yates contacted us early in the planning process to offer the restaurant's docks, as well as



# DELTA DOO DAH

those of neighbor Boyd's Harbor, as an official stop. Yates, who keeps his Wylie 34 *Coyote* at Boyd's, volunteered to not only coordinate fitting all the boats into the tiny basins, but also to arrange some fun activities for the fleet. When asked which harbor he was affiliated with, he replied "Neither. I'm friends with the owners and just think it'd be fun."

Doo Dah boats began trickling in just after lunch, and continued into the late afternoon. Yates managed to shoehorn 25 boats into the two basins. "We've had more boats in here," Yates said, "but never this many big boats — and never this many sailboats. The locals have been coming down all day to take pictures."

After the majority of boats were settled, Yates then shuttled folks to a nearby beach, where he'd arranged shade, cold drinks, snacks and an assortment of water toys — including three PWCs and a Hobie 16 borrowed from neighbors. "Peter is just amazing," effused Patti Boucher of the Santana 22 *Carlos*. "Our boys had such a great time!"

Everyone else apparently did too, as evidenced by the nearly \$300 collected during a hat-passing at dinner. Yates was humbled by the gesture. "I just wanted to throw a good party," he said.

Those who arrived later in the day, or simply chose to stay behind, enjoyed a lazy afternoon — until Official Doo Dah Troublemaker Robbie Gabriel declared war with a gigantic water cannon. Chaos ensued, with every remaining Doo Dah'er getting into the action. Some attacked from the water while others retaliated from the relative safety of their boats.

Aaron Dunlap — who flew down from his home near Seattle to sail aboard his Sausalito-based Valiant 32 *Feolena* — took the 'more is better' approach and grabbed a bucket.

Regardless of where they spent their afternoon, the fleet met up again at the Rusty Porthole for dinner. Owner Belinda Bittner's staff expertly handled the 70 or so crazies that descended on the restaurant like locusts. After the crowd was sated, the party moved to the deck — where Yates had set up some amps — and rocked the night away. Ok, no one made it past 11 p.m.



**Robbie 'Troublemaker' Gabriel.**

Belinda Bittner's staff expertly handled the 70 or so crazies that descended on the restaurant like locusts. After the crowd was sated, the party moved to the deck — where Yates had set up some amps — and rocked the night away. Ok, no one made it past 11 p.m.

**T**uesday was the first of three so-



LATITUDE / DODETTE CHRISTINE

LATITUDE / 'DOO' JOHN A.

called 'free' days — a time for folks to split off on their own for a little exploration. Several Doo Dah'ers spent the morning consulting charts and grilling Yates on the best routes to take to their chosen destinations.

One by one, the fleet peeled off, some heading to the Meadows, some to Venice Island, some to Georgiana Slough. About one-third of the fleet made their way to Little Mandeville Island, where they tucked into a shallow horseshoe bend

off Connection Slough that was later dubbed 'Broken Rudder Slough'.

The sweltering heat and lack of wind caused most boats to quickly rig tarps and bug screens. After those chores were complete, though, it was play time. For some, play time meant kicking back with a book and a refreshing beverage. For others, it meant a little light air dinghy sailing. For Valencio and Tino Grygier





KATHE HASHIMOTO



LATITUDE / 'DOOD' JOHN A.



RUBEN & ROBBIE GABRIEL



**Doin' the Dah** — Top row (l to r): A total of 22 Doo Dah'ers crammed onto 30-ft 'Windsome Wench' for cocktails; Adam Correa of 'Tamara' gets the hang of skurfing; (top) Peter 'Our Hero' Yates; (bottom) 'Volaré's Elani Casero, 9, snuggles up to Zebulon; smooth sailing — ok, motoring; whoopin' it up at the Hoopla. 2nd row: Sophia & Jeffrey Anderson-Lee of the Coronado 34 'Galadriel' know how important shade is; Jane, Emily, Hannah, Maddie & Cate show the boys how it's done; Wayne & Karen Edney of the Bristol Channel Cutter 'Odyssey', their crew Lisa Parr, and Gary & Nancy Ryan of the Hanse 34 'Iliohale' decide on their next stop. 3rd row: Tino (flying) and Valencio's boat 'Carlos' earned the nickname 'Surf & Turf' (a Tuna towing an *El Toro*); Mary Lovely of the Cal 40 'Green Buffalo' was thrilled her prize matched her outfit; 'Moondance' basks in the hot Delta sun; the epic water battle at Broken Rudder Slough will go down in the annals of Doo Dah history.



JAY HICKMAN

(ages 13 and 12) of *Carlos*, play time was water time. It didn't take long for them to engage nearby boats in a water battle.

"We were a little worried that there weren't any other kids in 'Broken Rudder Slough,'" said dad Jan Grygier. "But the adults here act like kids, so it's turned out well."

In the meantime, the wind picked up enough that the sailing became inter-

esting — a little too interesting for one sailor. "I was just scooting along," he said, "when suddenly the boat lurched and half the rudder popped up beside me." A replacement rudder made of scrap plywood — hand-delivered by Peter Yates the next day — also snapped, earning the cove its nickname.

Rumors began circulating through the anchorage on Wednesday that the crew of Greig and Leslie Olson's *Searunner 40 Doggone* were planning a not-so-secret

attack on other boats. Forewarned is forearmed, so a supply of biodegradable water balloons and fully loaded cannons awaited them.

As expected, the crew of the tri proudly flew their pirate flag as they dinghied over to a certain three-boat raft-up. In a show of trimaran solidarity, Ari Samole, skipper of the Lock Crowther Buccaneer 24 *Kalona*, and his crewmember, Chris Almquist, also took up arms against the monohulls. It's sad, really,



# DELTA DOO DAH

that they were so soundly spanked.

Heh hem.

Similar craziness undoubtedly sprouted up wherever Doo Dah'ers landed during their free days, and we wish we had room to share it all. Needless to say, Friday came all too soon. "I could have spent another week out here," said Jay Hickman of the Ericson 29 *Moor'ea* as he lounged in a hammock.

Not wanting to miss the final Hoopla Party, Doo Dah'ers made their way from all over the Delta to converge on Stockton Sailing Club on Friday, July 3.

**S**tockton Sailing Club is famous for its hospitality, and it certainly lived up to its reputation. As Doo Dah boats — easily identified by the event's screaming yellow burgee — approached the club in the early afternoon, a crash boat met each one to give them their slip assignment. Once tied up, they were greeted by club members bearing hot-off-the-press issues of the July *Latitude*. "I was hoping they'd be here," exclaimed Ben Mewes of the custom Van de Stadt 41 *Georgia*,



**John Chille & Lisa Donovan will take their Golden Gate 30 'Love in Vane' on the 2010 Ha-Ha.**

who quickly ran off to the air conditioned clubhouse to grab a beer while he read the magazine.

The club also made available a fleet of Optis and FJs for daysailing, and a shuttle to take folks to West Marine and the grocery store. And it was their efforts that really helped make the Hoopla memorable.

Starting with a mouth-watering BBQ dinner, the party got underway. Doz-

ens of Doo Dah'ers and club members crowded the pavilion to gorge themselves before the 'Dood' and 'Doodettes' (John Arndt, Christine Weaver and yours truly) had the pleasure of doling out prizes to every single entry. Some even got two! (Check out all the swag at [www.deltadoodah.com/sponsors](http://www.deltadoodah.com/sponsors).) To top off an already great party, the Blue Water Rockers got the crowd on their feet with some classic rock.

On July 4, the fleet dispersed — some beat their way back to the Bay while others stuck around for the Hilton family's annual Fireworks Extravaganza. As each boat motored out, a certain melancholy grew — it had been a frenetic and fantastic week, and now it was over.

**B**y all accounts, the inaugural Delta Doo Dah really hit the mark. Participants raved, but even more importantly, shared their ideas for making the event even better. And while the dates haven't been set, it seems certain that there will indeed be a Delta Doo Dah Deux.

— *latitude* /ladonna

**Owl Harbor**  
MARINA

Beautiful 20 acre greenbelt park in the Heart of the Delta

- 30' - 50' berths @ \$5.50 per foot
- Home of Andreas Cove Yacht Club

Located on Seven Mile Slough, just off the San Joaquin River

1550 W. Twitchell Island Road • Isleton, CA 95641  
916.777.6055 • [www.owlharbor.com](http://www.owlharbor.com)



# VALLEJO MARINA

Gateway to the  
Bay & Delta



Join us!  
We love making new friends  
and spoiling them!

- Competitive Rates!
- Ample Guest Dock
- Full Service Boat Yard and Chandlery
- 2 Restaurants for Breakfast, Lunch, Cocktails and Dinner
- Covered and Open Berths



*Join us for those  
warm summer nights!*

- One hour from Sacramento
- Only three hours from Reno
- Easy access to San Francisco Bay and the Delta

**(707)  
648-4370**

Fax 707-648-4660  
42 Harbor Way  
Vallejo, CA 94590

[www.ci.vallejo.ca.us](http://www.ci.vallejo.ca.us)

## SAILBOATS ONLY



[www.hiddenharbormarina.com](http://www.hiddenharbormarina.com)

*Turn the page . . .*

*To your next  
Sailing  
Adventure.*

**FUSION  
CATAMARANS**

Ph: (604)465-1662  
Email: [bmax242@yahoo.ca](mailto:bmax242@yahoo.ca)



# SOLO SENSATION —

In a scene reminiscent of Sir Francis Chichester's homecoming to England aboard *Gipsy Moth IV* in 1967, 17-year-old solo circumnavigator Zac Sunderland was greeted by hundreds of well-wishers and a blitz of reporters July 16, when he returned to his Marina del Rey homeport. Upon arrival, he became the youngest sailor to round the planet alone by any route.

From several miles offshore, dozens of boats escorted Zac's 1972 Islander 36 *Intrepid* toward the marina, all jockeying for position so those aboard could catch a firsthand glimpse or snap a photo of the handsome, shaggy-haired sailor who'd become their hero during his 13-month around-the-world odyssey. Via Zac's frequent blog postings, and both national and international news reports, thousands of armchair voyagers young and old had followed his progress, vicariously celebrating the high points and suffering through the lows that invariably make up any long-distance ocean voyage.

In an era when most Americans are desperate for the smallest kernel of uplifting news, Zac Sunderland's feat is like a welcomed breath of fresh air.

The oldest of seven children, and son of a professional shipwright, Zac grew up around boats, and lived aboard for nine — now, make that 10 — of his 17 years. When he was younger, the

**"Yup, I must be back in L.A." After stepping off 'Intrepid', the shaggy-haired record-breaker faces a media onslaught.**

family spent three years cruising Mexico and the California coast. Back then, and later, during boat deliveries with his dad, he learned and practiced marlinspike seamanship and navigation.

Being a 'boat kid', it's no surprise that

*His campaign was truly a family effort that they all can be proud of.*

one of Zac's childhood heroes was Robin Lee Graham, who left Southern California at age 16 in 1965 and singlehanded around the world aboard a Lapworth 24 named *Dove*. (For the record, he actually completed the final legs of the trip aboard the Luders 33 *Return of Dove*.) Although Zac has never met his reclusive hero, he credits Graham's feat as a major inspiration. In fact, Zac's route loosely followed Graham's: west-about via the Cape of Good Hope and the Panama Canal.

Australian solo circumnavigator Jesse Martin is also acknowledged as a major influence. He currently holds the record as the youngest (18) to complete a non-stop, unassisted rounding via the 'great capes' (of the Southern Ocean). Those who savor such statistics are quick to point out that Zac's route, largely through the tropics, with many stops where he received extensive assistance,

pales in comparison to Martin's. That may be true, but from the outset, Zac's parents, Laurence and Marianne, were clear that they simply were not comfortable sending their son on Martin's more ambitious — and dangerous — route. And we can't say we blame them. From the beginning, Zac's simple goal was to round the planet safely and return home at a younger age than anyone had done previously. And that's precisely what he did. He takes the 'youngest around' title from another Aussie, David Dicks, who completed a solo lap in 1996 at age 18 and 41 days (slightly younger than Jesse Martin).

Early on, Laurence and Marianne endured criticism from self-righteous bloggers who charged that they were irresponsible — some even said negligent — for letting their son set off to sea alone. But we'd bet those critics were not sailors. If they had been, they'd have realized that Zac's life-long boating savvy, combined

with *Intrepid's* full range of modern safety and communications gear, his ocean crossings were probably substantially less life-threatening than driving on L.A. freeways. That said, we're reminded that Zac doesn't actually have a driver's license yet!

Zac bought *Intrepid* (ex-*Nantucket Sleigh Ride*) for \$6,000 with his own savings. His father and friends then helped him do an exhaustive refit, including installation of a new diesel engine and a custom hard dodger. The beefy hull may be old, but she's now equipped with a high-tech war chest of electronics: an AIS, two radars, a powerful computer with navigation and weather forecasting software, both built-





# ZAC IS BACK



**After secretly overnighing at a quiet Catalina cove, Zac brought 'Intrepid' back home to Marina del Rey and faced his adoring public.**

in and handheld GPSs, an SSB with a Pactor (email-enabling) modem and more.

Although the trip was Zac's dream, and it was Zac at the tiller during the 28,000-mile cruise, his campaign was truly a family effort that they all can be proud of. With each of *Intrepid's* many breakdowns, Laurence either coached Zac through necessary repairs or flew out to one of his far-distant stopover points to personally fix the problems himself. Meanwhile, Marianne served as the de facto communications ace, chatting with Zac twice daily via his Iridium satphone to get updates on his progress, inform him of the latest weather predictions and reassure him when he was

feeling blue, as only a mother can do. In the background, the rest of the Sunderland clan rooted their big brother on, as did throngs of young Southern California supporters who dubbed themselves the Zac Pack.

When the young adventurer headed west on June 14, '08, he appeared to be as well prepared as possible, except for the fact that he had never actually spent a night at sea all alone, despite having done plenty of singlehanded. During the early months of his 397-day cruise he admitted that he'd underestimated the toll that all that solitude would take on him — especially on frustrating days with no wind.

Nevertheless, with each of the many challenges he faced, he showed maturity and focus well beyond his years. Only four days after departure, for example, he had his first real scare when a proximity alarm warned him of a fast-approaching container ship that was headed right for him. He dodged it and watched it pass a quarter mile away.

There were plenty of tense moments for Laurence and Marianne too. Like when Zac was threading his way through the treacherous reefs of the Torres Strait and his satphone slipped into the sink, somehow causing it to transmit a false position report that put the boat 100 miles off course on a reef.

One incident which will undoubtedly be featured heavily in the book that Zac is close to completing, is the pirate scare that occurred last fall, while he was headed from Australia to the Cocos Keeling Islands. A sinister 60-ft vessel closely shadowed *Intrepid* for two hours, refusing to answer Zac's hail on VHF. When he called his dad for advice, Laurence told his son to load up the flare guns and issue a *sécurité* call over VHF. If you have to shoot, he told his then-16-year-old son, shoot to kill. Luckily, the mystery boat eventually veered off, and the family members breathed sighs of relief on both sides of the planet.

Other challenges included a broken boom that required a jury rig, multiple engine problems, a forestay that parted while *Intrepid* slid down 15-ft seas in the Indian Ocean, and a sneaker wave that broke over the transom in the middle of the night and worked its way down to the nav station, dousing electronics.

Some of the most frustrating sailing came on the homeward beat from Panama. With the finish line seemingly just beyond the horizon, the young voyager spent many agoniz-

*He'd underestimated the toll that all that solitude would take on him.*

ing days struggling against headwinds and current, or worse, no wind and sweltering heat. Then a tropical depression walloped *Intrepid*, busting loose a key bulkhead that secured essential chainplates. Zac limped into Nuevo



# SOLO SENSATION

Vallarta's Paradise Village not long before another storm built offshore into a Category 1 hurricane. As elsewhere, Laurence flew in and *Intrepid* was soon good to go again.

Minor tragedies aside, there were plenty of high times too. As word of Zac's bold endeavor preceded him to each of his many stopovers, he was almost always greeted as a hero by press and dignitaries, while local mariners bent over backwards to help him with repairs and resupplying.

Perhaps the most ironic day of the trip was when he found himself in South Africa at the exact time that British singlehander Mike Perham was there aboard his chartered Open 50 *TotalMoney.com*. He, too, was circumnavigating, but in the opposite direction. As we go to press, the 17-year-old Brit, who is 3.5 months younger than Zac, is about to head across the Caribbean and



RICH ROBERTS

*Members of the Zac Pack try to catch a glimpse of their young hero. Who knows? Perhaps one of them will follow in his wake someday.*

on to his UK homeport in pursuit of the young American's new crown.

Even if Perham is successful, we predict that it will be quite some time before anyone steals away Zac's status as the 'youngest American around' — unless,

of course, his 15-year-old sister Abby gets her wish!

As Zac, the 'solo sensation', achieved his seemingly unlikely goal, thereby proving the skeptics wrong, he undoubtedly inspired many other kids to stretch their imaginations and reach beyond the norm. We hope he'll now take some time to relax and savor the limelight of his newfound notoriety. At the age of 17, he's become an overnight celebrity and has been lauded by politicians as a true American

hero. Heck, even the Governor gave him a personal phone call!

It's interesting to note that as news of Zac's homecoming filtered into living rooms all across America, he accomplished an extra, unanticipated feat: Finally, someone found a way to make sailing ready for prime time.

— **latitude/andy**

## SCHOONMAKER POINT MARINA

• IN SAUSALITO •



Call the Marina Office  
for more information

**415•331•5550**

**FAX 415•331•8523**

or check our web site at  
[www.schoonmakermarina.com](http://www.schoonmakermarina.com)

85 LIBERTY SHIP WAY, #205  
SAUSALITO, CA 94965



### 160 Berth Marina in one of the most beautiful spots on the Bay

- Visitor berths • Guest moorage able to handle yachts up to 200 ft.
- Dry storage • Waterfront Offices • Three-ton Hoist • Windsurfing
- Deli • Beach • Rowing • Kayaking • Yacht clubs always welcome

# HARKEN FURLING

So reliable you'll relax –  
on the Bay or to Mexico and beyond.  
Upgrade with Harken and Easom.  
Call to schedule an installation.



**Easom Racing and Rigging**  
1150 Brickyard Cove Rd. Suite B1  
Point Richmond, CA 94801  
**(510) 232-SAIL (7245)**  
[www.easomrigging.com](http://www.easomrigging.com)

## 30 Years Young!



This 1979 Achilles Hypalon inflatable is in for repairs to a couple of small holes and a new keel.

Hypalon is a miracle material, and Sal's repair team are miracle workers.

Buy new or repair the old – either way it's a great value!

**SAL'S**  
INFLATABLE  
SERVICES, INC.

PHONE (510) 522-1824

FAX (510) 522-1064

1914 Stanford St., Alameda 94501

[salsinflatables@sbcglobal.net](mailto:salsinflatables@sbcglobal.net)

[www.salsinflatableservices.com](http://www.salsinflatableservices.com)

SALES • SERVICE  
RENTAL • REPAIR

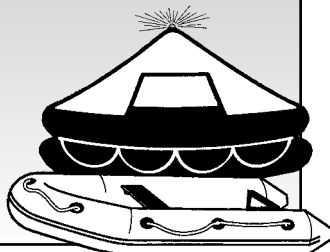

## THE GREEN SOLUTION!

*A windvane self-steering system from Scanmar*

Cruise around the world  
without using a drop of oil  
– not even for lubrication!

- No fuel consumption
- Uses FREE wind & water power
- Reliability proven for decades
- Quiet & powerful
- Emergency rudder



Rated 'Best Windvane' in the ARC

[www.selfsteer.com](http://www.selfsteer.com)



FACTORY DIRECT

**SCANMAR**  
INTERNATIONAL

432 South 1st St. • Pt. Richmond, CA 94804

Tel: 510 215-2010 • Fax: 510 215-5005

Toll Free: 888 946-3826

email: [scanmar@selfsteer.com](mailto:scanmar@selfsteer.com)



# PUDDLE JUMP RECAP

The year 2009 was, in all ways, a record year for the Pacific Puddle Jump. More boats registered in '09 than ever before, more pre-crossing seminars were held, there were generally better weather conditions. . . All in all, it was an outstanding year.

One hundred boats registered on the Puddle Jump's informational site at Yahoo.com, and nearly that many registered on *Latitude 38's* annual fleet list. Most left from ports in Mexico, a sizeable number from Central and South America, and several directly from the U.S.

Much of the increase in numbers is probably attributable to the much-talked-about

'bond exemptions', arranged through the efforts of *Latitude 38* and the Tahiti YC. It was the first time Pacific Puddle Jump boats were allowed to enter French Polynesia without having to post the normal bond (equivalent to the price of a flight home) that's required for all non-EU citizens. Check-ins for exempted boats were very quick and efficient. Hopefully bond exemptions will become a regular feature of future Puddle Jumps.

As reported last month, the three-day Tahiti-Moorea Sailing Rendezvous was a huge success, with 60 boats attending the cultural exchanges, beach games and parties.

Sadly, the '09 South Pacific cruising season was marred by several disasters. Two former Puddle Jump boats sank while making passages: The Ventura-based *J/44 Elusive* went down during a crossing from New Zealand to Fiji, and the Santa Rosa-based *Trintella 53 Sumatra* sank en route from New Caledonia to Australia. Fortunately, both crews were rescued. The greatest tragedy concerned the '09 Puddle Jump boat, *Emily Pearl*. She was found holed and sunk off the southwest coast of Nuku Hiva less than a week after making landfall at Taiohae Bay. Singlehander Billy Landers was never found and is presumed dead — the first fatality in

Puddle Jump history. His tragic loss was deeply felt by all in the fleet.

Weather comparisons tend to dominate discussions between South Pacific cruisers. This year the luckier members of the fleet had great conditions: steady winds and few squalls in the Inter-Tropic Convergence Zone (ITCZ). The

ITCZ is a band of unsettled air just north of the equator. Squalls and heavy rain — sometimes of biblical magnitude — can be found there. When crossing it, timing is everything. Even

a week's time can mean significant differences in weather patterns.

For example, the first boats out of La Cruz, Mexico had great conditions and fast passages. Boats in other groups found calmer conditions and had longer passages. Only a few boats encountered severe ITCZ squalls approaching 40-knot winds. Happily, these squalls were fast moving, and even very 'entertaining winds' passed quickly.

First-time passage-makers are usually overly concerned about the ITCZ, and spend a lot of energy worrying about where to cross it. The best advice is to just go toward the equator and when the ITCZ is encountered turn directly south and get through it quickly.

Boats crossed the equator between 127°W and 133°W, a span of 360 nm. Another important point to clarify is that you will encounter the ITCZ only once. On the other side of the equator is the SPCZ (Southern Pacific Convergence Zone) that snakes throughout the South Pacific and will typically be encountered time and time again by cruisers.

Calm conditions were a common complaint this year. As the *Follow You Follow Me* crew reported, "We had light winds and not enough squalls! Given our watermaker failure, we were looking forward

to strong trades to move us along, and squalls to fill our water tanks. It seems that boats that left two weeks before us

*"The long passage was rewarded manifold by the amazing beauty of this place."*



For many Puddle Jumpers a traditional Polynesian tattoo makes a perfect souvenir.



and two weeks after got more of both!"

Once the fleet arrived in French Polynesia, I asked them to share insights and impressions. The following are excerpts from those reports. Take a look also at the Passage Data table on page 110. You may find the comparisons both fascinating and educational, as I do.

— Bob Bechler

## Crossing Notes from the Fleet

"We hooked a marlin bigger than our crew! Thankfully it broke the leader.

"All in all we had fabulous weather and good winds. We had far more wonderful days of sailing than challenging ones. Adored the gorgeous display of stars, phosphorescence and at least one amazing green flash. After such a long passage, the normal thrill of arrival is intensified. The long passage was rewarded manifold by the amazing beauty of this place.

— Philip DiNuovo & Leslie Linkkila  
Carina, Mason 33

"We were pretty well set up for the crossing. In her *Cruising Handbook*, Beth Leonard does a good job outlining this subject. We ate well. Fresh food for 2/3 of the passage! Bad times were when we were in the squalls and in the boisterous NE trades for more than a week. Great times when we were out in the cockpit

# — LIFE IN THE SLOW LANE



SISIUTL

***Inset: At the equator Pollywog Lori shares a toast with King (Chris) Neptune. Spread: Flat water is the norm in the ITCZ.***

and we were zooming south! What a trip. What an experience!"

— David, Jill & Rachel Heimke  
Amikuk, *Crealock 37*

"We should have brought vegetable and fruit tree seeds to trade for produce and supplies in the Marquesas and Tuamotus. Also should have brought more chocolate, raw nuts, canned fruits and veggies for us. Cigarettes, liquor, and .22 caliber bullets are popular for trading, but we're too timid for smuggling.

— Larissa & Hobson Lane  
Australis, *Antigua 44*

## Puddle Jump Resources

- A non-commercial informational website is maintained for Puddle Jumpers at [www.yahoo.com](http://www.yahoo.com) (>groups>pacificpuddlejumps). Of particular note is the 500-page Crossing Guide, a great resource for anyone preparing for a Pacific circuit.

- The homepage for Latitude 38's annual Pacific Puddle Jump rally to French Polynesia is at [www.pacificpuddlejumps.com](http://www.pacificpuddlejumps.com). There you'll find articles and photos in downloadable archives, plus fleet lists and updates on the current year's migration — including bond exemption updates.

"The first third of the trip was slow until we got to the trade winds. Next third was quick in the trades — we were doing 150 mile days, with 12 to 15 knots SE winds day and night. We had the genniker up for 10 days and nights on the same tack. Last third of the trip was medium speed.

"It was great to have the bond exemption arranged for us. Our check-in took three minutes! One (non-Puddle Jump) yacht took four days to check in while trying to get his bond money from U.S. He tried using his credit cards, but his bank immediately froze his accounts.

Fatu Hiva was magic — it's said to be the most beautiful anchorage in the world. There's a great waterfall walk and good trading with the locals. We traded a 6-pack for a one-legged goat!"

— Peter & Nikki Zabel  
Bagheera, *Jaguar 36 cat*

"The mainsail track on our in-boom furling system broke off (top 6 feet). Sailed with a reefed main most of the way. Even with that our best day was 231 miles and the worst was 139. Sea life spotted: whales, mola mola (sunfish), baby whale shark, dolphins, flying fish and squid. We were all out in the cockpit when we heard a thump, then saw a fairly large fin off the right rear corner of the boat. Mike recognized it as a Mola Mola. They are slow movers and often asleep. Neither the starboard daggerboard (which lifted a few feet) nor the Mola Mola seemed worse for wear.

— Scott & Cindy Stolnitz, Mike Lonnes  
Beach House, *Switch 51 cat*

"Two 30-lb tuna caught and a few escapees. We tried a lot of lures, had a line out every day and only caught these two the whole time. Prepare for light winds!"

— Patrick & Rebecca Childress  
Brick House, *Valliant 40*

"We had consistent heavy wind and seas in the NE trades after the first two days out. Wind south of the equator was generally too light for the sea conditions. Hard on the sails. Entire trip was very rolly. Often had seas that did not reflect the current wind conditions which was rather frustrating. Lots of squalls starting at about 7° N. As with any long crossing there are good days and bad days. With only two aboard, it can get a little lonely on alternate watches."

— Wayne Wilson & Susan Leader  
Daydream, *Metalu 50*

"We could take daily showers for three

***Some passage-makers saw dolphin, others saw whales, but it seems that everyone got their fill of flying fish.***





# PUDDLE JUMP RECAP

people from the water we caught!

— Jackie & Neil Michell & Stan Starkey  
Camelot, Pan Oceanic 46

"Only saw three commercial vessels on the radar in 20 days, but more than 24 squalls! None generated more than 25 knots of wind, though. We saw a floating marine BBQ (rusting) 1,000 miles out, followed by a blue jerry can.

— Dietmar Petutschnig, Kurt Roll,  
Suzanne DuBose, Carolyn Sherman  
Carinthia, Lagoon 440 cat

"On day two of the crossing our autopilot failed, so we hand steered for the next 22 days! The trip, other than tiring, was really quite nice. The various sunrises, and sunsets, the squalls dropping rain and wind, the various cloud patterns never let us get bored.

— Mike & Mary McCluskey  
Carpe Vita, Shuttleworth 43 cat

"Our watermaker went out on day six, forcing us to expedite our passage via motoring, as we only had 75 gallons

of water when it broke. We hit a flat spot about 75% of the way across, and our blog comments reflected it. Several people emailed us back, reminding us

*"We adored the gorgeous display of stars, phosphorescence and at least one amazing green flash."*

that we were doing something very special that very few people will ever do and to stop feeling sorry for ourselves!

— Allan, Rina & Alyssa Alexopoulos  
Follow You Follow Me, Hunter 466

"It just took us four days to get the trade winds. We were really happy about that and had a fast crossing. We only had one or two days with rain and just a little squall activity. One single bottlenose dolphin guided us to Baie Hanavave.

— Axel Brill & Brit Gebhardt  
Hello World, Sunbeam 53,

"The squalls were very anticlimactic. Mainly they were mild and the wind actually died when the rain passed through. But we had constant 20- to 30-knots winds for 80% of the passage. We did get into the groove and were in harmony with the wind and waves as the days passed by. It's a long way out there, but the rewards of landfall are beyond imagination."

— Roger, Bobbie Jo & Robin Curley  
Hipnautical, Morgan O/I 51

"Received an email two days from Hiva Oa saying that S/V *Inherit The Wind* was having difficulty. Turned around and, with the help of the Pacific Seafarers Net, vectored them, M/V *Tampa*, and us to a rendezvous point. *Tampa* transferred food and water, then we accompanied them for the next five days to Hiva Oa. The vessel *Ketchup II* met up with us at the end and towed the stricken vessel in to port.

— Joe Bayne & Dubis Blanco  
Jubilee, Corbin 39

## 2009 PUDDLE JUMP PASSAGE DATA

Boat Name	Boat Make & Length	Captain & Crew	Boat's Homeport	Departed From / Date	Landfall & Date	Days Xing	Miles Xing	Eqtr X Long.	Engine Hours	Best 24 Hr	Worst 24 Hr	# Fish Cght	Breakage & Breakdowns
<i>Amikuk</i>	Pacific Seacraft 37	Heimke family, Terry Cady	Homer, Alaska	Puerto Vallarta 4/2	Nuku Hiva 4/27	25	2,900	131°		155	51	2	spinnaker clew, autopilot
<i>Australis</i>	44' ketch	Larissa & Hobson Lane	Pascagoula, MS	La Cruz 4/23	Nuku Hiva 5/18	24	2,000	131°	92	140	75	1	autopilot, jib ripped, watermaker
<i>Beach House</i>	Switch 51 cat	Scott & Cindy Stolnitz	Marina del Rey, CA	Galapagos 5/31	Hiva Oa 6/17	17	3,250	89°	70	231	139	n/a	mainsail track
<i>Brick House</i>	Valiant 40	Patrick & Rebecca Childress	Middletown, RI	Galapagos	Hiva Oa	25	2,850	90°	31	144	43	2	spinnaker ripped; DVD player
<i>Camelot</i>	Pan Oceanic 46	Jackie & Neil Michell	UK	Galapagos 2/25	Marquesas	22	3,061	n/a	70	170	89	n/a	whisker pole broke, sail ripped
<i>Carina</i>	Mason 33	Leslie Linkkila, Philip DiNuovo	Kingston, WA	Galapagos 4/8	Hiva Oa 5/6	28	3,127	88°	28	152	77	1	whisker pole mast fitting bent
<i>Carinthia</i>	Lagoon 440 cat	D. Petutschnig, S. DuBose, C Sherman, K Roll	Las Vegas, NV	La Cruz 3/12	Hiva-Oa 4/2	20	2,952	130° 32'	36	198	117	n/a	autopilot, topping lift, nav wiring
<i>Carpe Vita</i>	Shuttleworth 44 cat	Mike & Mary McCluskey		Galapagos 5/1	Hiva Oa 3/24	23	3,047	88° 36'	50	164	86	0	autopilot, spinnaker, batten car
<i>Cooee Too</i>	Van de Stadt 50	Bronte Heinrich, Helmke Moller	UK	Galapagos 3/29	Hiva Oa 4/18	20	3,163	n/a	n/a	180	137	9	freezer compressor, sail tears
<i>Daydream</i>	Selesira 50	Wayne Wilson & Susan Leader	Ladysmith, Canada	Chamela Mexico 3/14	Hiva Oa 4/6	23	2,856	128° 42'	47	159	91	0	foresail halyard, hydraulic steering
<i>Follow You Follow Me</i>	Hunter 466	Allan & Rina Alexopoulos	Volcano, CA	Banderas Bay 3/21	Hiva Oa 4/14	24	3,000	125° 18'	171	145	60	1	watermaker, chartplotter, autopilot
<i>Hello World</i>	Sunbeam 53	Gebhardts & Capt'n Bluebear	Flensburg, Germany	Panama 4/8	Fatu Hiva 4/26	18	3,117	89°	37	206	125	1	autopilot
<i>Hipnautical</i>	Morgan O/I 51	Curley family	Ventura, CA	La Cruz 3/10	Hiva Oa 4/2	21	3,000	128°	30	172	63	0	jib & reefing lines chafed
<i>Jubilee</i>	Corbin 39 ketch	Joe Bayne & Dubis Blanco	Norfolk, VA	Galapagos 4/21	Hiva Oa 5/19	28	2,776	n/a	12	164	57	1	fuel line problems
<i>Julia Max</i>	Passport 45	George & Sue Stonecliffe	Portland, OR	Puerto Vallarta 3/15	Hiva Oa 4/06	23	2,740	129°	120	156	75	0	alternator, mainsail batten pocket
<i>Kalalau</i>	43' sloop	George Hill, Kathleen Whitney	Port Townsend, WA	La Cruz 3/28	Nuku Hiva 4/21	25	2,863	132° 27'	122	192	90	n/a	lower shroud snapped
<i>La Palapa</i>	Catalina Morgan 440	Roger & Chuck Hayward	Long Beach, CA	La Cruz 4/03	Hiva Oa 4/23	20	3,000	132° 05'	80	170	120	0	generator impeller, inverter fan
<i>Lightheart</i>	LeComte 45c	Steve & Carolyn Bowie	Seattle, WA	Banderas Bay 3/28	Nuku Hiva 4/21	24	2,790	132° 09'	100	175	80	n/a	snap ring on windvane
<i>Mandolin</i>	Panda 40	Chris Thompson & Lori Serocki	San Diego, CA	San Diego 4/19	Nuku Hiva 5/18	30		128°	30	150	60	0	compass on autopilot
<i>Milonga</i>	Horstmann 40 trim	Elke & Torsten Debus	Lübeck, Germany	Punta Mita 3/15	Hiva Oa 3/15	22	2,740	129°	110	155	0	0	none
<i>Obsession</i>	Cal 39	Les George, John Erhardt	Oceanside, CA	Cabo San Lucas 3/21	Hiva Oa 4/08	18.5	2,800	128° 44'	52	168	130	3	head stay extrusion screw
<i>Romany Star</i>	Ohlson 38	Paul & Erin Moore	Seattle, WA	Galapagos 3/21	Gambiers 4/19	29	2,900	n/a	1	156	22	1	shaft seal & chafed windvane lines
<i>Sisiuti</i>	44' Gulfstar Ketch	Bob & Carylina Bechler	Portland, OR	La Cruz 4/24	Nuku Hiva	31	2,972	128°	20	128	25	n/a	alternator, autopilot
<i>Tarahumara</i>	45' CNZ Catamaran	J Sibthorpe, C Bryden, G Marsh	Alberta, Canada	La Cruz 4/5	Hiva Oa 4/23	19	3,000	130°	70	200	80	3	lost rudder 100 miles from Tahiti
<i>Tender Spirit</i>	Hans Christian 33	Joan & Chuck Martin	Sitka, Alaska	Mazatlan 3/12	Hiva Oa 4/15	34	3,286	128°	75	127	20	n/a	chafing of windvane steering lines
<i>Thin Wolf</i>	KP 44	Luke Tornatzky, Mike Ward	Port Townsend, WA	Banderas Bay 3/16	Hiva Oa 4/12	27	3,000	127° 43'	15	170	0	0	windvane problems
<i>Thumbs Up</i>	Catalina 42	Orgee family, C Graveson, A Ross	Alameda, CA	Puerto Vallarta 3/17	Hiva Oa 4/6	20	3,000	130°	n/a	n/a	n/a	0	mainsail holed, traveler
<i>Victory Cat</i>	Seawind 1160 cat	Tim & Ruth Henning	Anthem, AZ	Punta Mita 3/30	Hiva Oa 4/23	23	2,844	127° 18'	60	157	79	2	main halyard 2:1 block ripped out
<i>Warrior</i>	Britt Chance Design	Robin & Michelle Bendall	Launceston, Australia	Panama City 2/14	Gambiers 4/28	39	4,300	88°	70	182	37	9	whisker pole, drifter, autopilot
<i>Whisper</i>	Tartan 37	Malone family	Seattle, WA	La Cruz 3/17	Hiva Oa 4/09	23	2,700	129°	1	160	67	0	tore spinnaker
<i>Yaraandoo II</i>	Joe Adams Naut 40	Mike & Sue Powell	Sydney, Australia	La Cruz 3/21	Nuku Hiva 4/18	23	3,093	129° 30'	41	173	96	0	autopilot, traveler shackle
<i>Yohelah</i>	Baba 40	Rob & Teresa Sicade	Seattle, WA	Galapagos 4/8	Fatu Hiva 5/2	24	3,165	89°	74	166	99	7	autopilot
<i>Zephyra</i>	Morgan 41 OI Ketch	Russ & Debbie Noorda	Lake Tahoe, CA	Galapagos 4/21	Hiva Oa 5/13	22	3,186	086° 17'	56	180	104	0	ejected main mast partner

Please note: Many more vessels did the Puddle Jump this year, of course, but those who responded give a representative sampling of passage data.

# — LIFE IN THE SLOW LANE



**Mike McCluskey found that fruit is often free for the taking. Naomi and Veronica ride 'Apple's bow. Tobe and Roger chill aboard 'La Palapa.'**

"One-pot meals worked the best. Sue baked pineapple upside down cake for crossing the equator. Of course. Sue, the Pollywog, had to undergo 'the cleansing' which included a special hot swirl applied by toothbrush to the mouth, and shaving cream applied to the face and removed by a squirt gun. Martinelli's was given to King Neptune."

— George & Sue Stonecliffe  
Julia Max, Peterson 45

"King Neptune tests all those who dare to enter his realm, including us. On day 16, after some squalls passed, we had some very strong winds and a wonderful sail in 20- to 25-knot winds. Just as everything started settling down we heard a loud noise but could not locate its source. George discovered the lower port shroud had snapped. On further inspection the middle port shroud was only half attached. The winds were calm the next two days, so George was able to climb the mast and reinforce the middle shroud with a halyard and put a clamp on the wires. He disassembled the lower shroud and reused most of the wire, then added chain so he could reattach it."

— George Hill & Kathleen Whitney  
Kalalau 43' sloop

"We were really glad we stocked up on \$3 plastic bottles of alcohol in Mexico. Investing in the BGAN satellite communications system allowed constant phone and Internet connections. A 45-ft sailboat sounds spacious until you realize that it is the exact size of your dream walk-in closet, and now you are stuck living in that dream closet with your husband. That said, we were amazed how quickly the trip went by, and how busy we were the whole time."

— Roger & Tobe Hayward  
La Palapa, Morgan 440



NATHAN BECKORD

"Great sailing at night wing-on-wing with a full moon lighting up the boat and low clouds all around at the ITCZ. The passage was tiring, as we were unable to sleep well for more than two hours at a time. At the equator we had a toga party and a champagne toast to Neptune."

— Steve & Carolyn Bowie  
Lighthearth, 45' LaConte

"Flying fish numbered in the trillions it appeared. If we could only harvest these little buggers and sell them, we might be able to continue cruising forever. As for advice to anyone who shares this dream of spending all your money on overpriced gadgets and gear that will break sooner or later, the most useful items we brought were: 1) each other; 2) our Monitor windvane, which allowed us to cook, clean, and carry on our lives without constantly steering or depleting our batteries; 3) our bimini and cockpit enclosure that kept us warm in the higher latitudes, relatively dry in the rain and heavy seas, and protected us from the sun below the equator. But really the most important part is following through with your dreams. The diversity of boats and equipment here in Nuku Hiva shows that there is no 'best' way to get here. On one side of us is a 150-ft multimillion-dollar luxury yacht, and on the other, a 24-ft fiberglass sloop."

— Chris Thompson & Lori Serocki  
Mandolin, Panda 40

"We saw plenty of flying fish. One hit me right on the forehead while I was



LA PALAPA

dozing on my watch. At the equator we had a dinner party, movie night and a full night's sleep for both of us on a flat calm glassy ocean."

— Torsten & Elke Debus  
Milonga, Horstmann 39 tri

"This is the 4th Pacific Puddle Jump for me and the first for my wife, Carylina. We sailed from New Zealand to California and Mexico last year to catch the '09 Puddle Jump. The alternator failed, requiring us to terminate all non-essential electrical drains. We ate like kings and queens for a few days working thru the thawing freezer items. Later, a steering cable break and autopilot failure added to the issues we had to deal with."

— Bob Bechler & Carylina St. Clair  
Sisiutl, Gulfstar 44

"We lost one rudder 100 miles from Tahiti. At the equator 'some' of the crew wore a dress, so pictures were not allowed!"

— Jim Sibthorpe, C. Bryden & G. Marsh  
Tarahumara CNZ 45 cat

"Wherever we went, the wind was not there! It was like chasing a rainbow. Our best sailing turned out to be in the convergence zone. On one windless day we spotted a turtle. As we were

watching it, it passed us by and left us far in its wake!"

— Joan & Chuck Martin  
Tender Spirit, Hans Christian 33

"Joan and Chuck on *Tender Spirit* deserve the Heroes of the Puddle Jump award because they so graciously slowed down to let us catch up with them, 900 miles off Mexico, so they could give us their spare safety tube for our Monitor windvane. Otherwise, we were faced with

**"King Neptune tests all those who dare to enter his realm, including us."**



# PUDDLE JUMP RECAP

hand steering the whole way or turning back.

— *Luke Tornatzky, Mike Ward & Lyon Omohundro*  
Thin Wolf, KP 44

"Life is pretty simple at sea. It is much more complicated in port. Everything went according to plan. The wish list includes new sails, newer engine, bigger boat, refrigeration, more power to run the radar, a watermaker and sundry other nice-to-haves, but not at the cost of staying home to pay the bills."

— *Scott, Mary, Timothy & Finn Malone*  
Whisper, Tartan 37

"We hit 10.2 knots in the middle of one night: Devon was on watch and she woke me up with, 'Hey dad we're doing over 10 knots.' It's amazing how quickly you can get on deck."

— *Ivan, Cheryl & Devon Orgee, Carlee Graveson, Alan Ross*  
Thumbs Up, Catalina 42



**Aboard 'Sisiutl' every crew member is sub-poenaed before King Neptune at the equator — even the ship's cat.**

"We spotted giant manta rays (at San Benedicto Island), blue whales, dolphins and millions of flying fish. Had to clear the decks almost daily of squid and flying fish. We had almost complete solitude on the crossing — sighted only one other boat. There was indescribable euphoria when we successfully completed our Pacific crossing."

— *Tim & Ruth Henning*  
Victory Cat, Seawind 38 cat

"We took a southern route: First to the Galapagos, then down to Easter Island, on to Pitcarin Island, and entered French Polynesia through the Gambiers. Not a well-traveled route, but well worth the extra miles."

— *Robin & Michelle Bendall*  
Warrior, 50' custom sloop

"Thankfully, this was an exceptionally uneventful and nice passage. Maybe I should go back and read my blog entries and see if it really was as nice as we remember!"

— *Rob & Teresa Sicade*  
Yohelah, Baba 40

"The most amazing memory of this passage was my first ever sighting of a perfect rainbow at midnight under the light of a full moon. The rainbow was to starboard and the moon to port. It was awesome!"

— *Mike & Sue Powell*  
Yaraandoo II, 40' Naut Forty

## MORE SAVINGS! MORE FUN!

You are invited to our Open House  
on August 22nd from 11am-4pm

Stop by and meet our staff, mingle with our members and take a **free sail** on one of our fleet boats.

For information on August 2009 ASA sailing classes and our unlimited-sailing membership, visit  
[www.TradewindsSailing.com](http://www.TradewindsSailing.com).

### Basic Keelboat (101) - \$595

Aug 1,2,8  
Aug 3,4,5  
Aug 2,8,9  
Aug 5,6,7  
Aug 9,15,16  
Aug 10,11,12

### Basic Coastal Cruising (103) - \$795

Aug 8,9,15  
Aug 10,11,12  
Aug 19,20,21  
Aug 22,23,29  
Sept 12,13,19  
Sept 16,17,18

### Bareboat Chartering (104) - \$995

August 9,15,16  
August 26,27,28  
Sept 13,19,20  
Sept 20,26,27  
Sept 27 & Oct 3,4  
Sept 30 & Oct 1,2

## Summer Special!

Take **\$100** off any of the below courses\*  
or take advantage of our 3 Class Package

(101,103 & 104) at **\$1895.00**



# Tradewinds Sailing School and Club

**More Experience. More Time on the Water. More Fun.**

**2580 Spinnaker Way, Richmond, CA 94804, (510) 232-7999**

# BAJA HA-HA XVI

BROUGHT TO YOU  
BY THESE  
OFFICIAL SPONSORS



Turn the page for more →

[WWW.BAJA-HAHA.COM](http://WWW.BAJA-HAHA.COM)

The Rally Committee encourages you to patronize the advertisers who make this event possible.

536 sailors completed  
Baja Ha-Ha XVI!

Your  
Yacht Club  
South of the  
Border



Home  
of the  
Banderas Bay  
Regatta

Vallarta Yacht Club

<http://vallartayachtclub.org>  
<http://banderasbayregatta.com>

Everything you need from a full service yacht club.

## ARE YOU READY TO HA-HA?

Check out the ever-expanding entry list of this year's rally and you'll see that there is no shortage of sailors eager to head south this year. With more than five weeks remaining until the September 10 entry deadline, 122 boats have already signed up, with homeports as diverse as Kauai and Montreal. The smallest so far is *Little Lara*, Jay Bowden's Pacific Seacraft 24 from Santa Barbara, and the largest so far is William Hogarty's Rhode Island-based Maxi 97 *Odysseus*.

If you're new to the event, let us explain that the Ha-Ha is a 750-mile cruisers' rally from San Diego to Cabo San Lucas, with stops along the way at Turtle Bay and Bahia Santa Maria.

You'll find frequent updates on this year's event, in addition to all sorts of other hot sailing topics at *Latitude's* three-times-weekly news portal, **'Lectronic Latitude'** (found at [www.latitude38.com](http://www.latitude38.com)).

Summer  
is safe at  
Paradise



Enjoy  
your stay  
with us!

Paradise Village  
BEACH RESORT & SPA

011-52-322-22-66728 • [www.paradisevillage.com](http://www.paradisevillage.com)  
marina@paradisevillagegroup.com



SCANMAR  
INTERNATIONAL Factory Direct

432 South 1st Street • Pt. Richmond, CA 94804  
Toll Free: (888) 946-3826 • Tel: (510) 215-2010  
email: [scanmar@selfsteer.com](mailto:scanmar@selfsteer.com) • [www.selfsteer.com](http://www.selfsteer.com)

**West Marine**  
We make boating more fun!™

Call 1•800•BOATING  
(1•800•262-8464)

for a catalog or the store nearest you.

Almar  
Marinas  
*The West's Finest*

Full service  
marinas –  
San Francisco  
to San Diego

[www.almar.com](http://www.almar.com)

Nautical Books, Software, Charts  
and more!



WAYPOINT

621 - 4th St., Oakland, CA

[www.waypoints.com](http://www.waypoints.com) • (510) 769-1547

**RIGGING  
ONLY**

Standing and running rigging, lifelines, furlers, winches,  
headsail poles, main slider systems, windlasses,  
travelers, wire terminals, blocks and more...  
Expert advice for selection and installation.

Our  
25th Year! [www.riggingonly.com](http://www.riggingonly.com)  
(508) 992-0434 • [sail@riggingonly.com](mailto:sail@riggingonly.com)

ICOM®  
Icom America Inc.

Award-winning Marine Communications Equipment  
Handhelds • Mounted VHF • SSB • Radar  
Visit one of our many West Coast dealers  
[www.icomamerica.com/marine](http://www.icomamerica.com/marine)



# BAJA HA-HA XVI

## BROUGHT TO YOU BY THESE OFFICIAL SPONSORS



### WWW.BAJA-HAHA.COM



NOW UNDER CONSTRUCTION

Contact Dockmaster: Juan Sebastian Estrada  
Ph/Fax from US: 011 52 322 297 7000  
juan@marinanuevovallarta.com  
[www.marinanuevovallarta.com](http://www.marinanuevovallarta.com)



Spinnaker & Genoa Sleeves  
Top/Mast Climber

GALE SAIL • TACKER

Sailing should be easy and safe

[www.atninc.com](http://www.atninc.com)  
(800) 874-3671



Let Marina El Cid  
Welcome You to Mexico

A Cruiser's Paradise!

[www.elcid.com](http://www.elcid.com)  
qcevallos@elcid.com.mx

011-52 (669) 916-3468

**¿ MEXICO BOUND ?**  
GERRY  
SEA of CORTEZ CHARTS  
Accurate Navigation Charts & Guides  
ELECTRONIC and PAPER  
[www.GerryCruise.com](http://www.GerryCruise.com)

Early Bird Rates



We Are Now Open!

MARINA RIVIERA NAYARIT  
AT LA CRUZ

The best marina – 25 minutes away from Puerto Vallarta  
Tel: 322 779 91 91 or 329 29 555 26  
info@marinarivieranayarit.com  
[www.marinarivieranayarit.com](http://www.marinarivieranayarit.com)

### MEET THE FLEET

Among the important dates to note (at right) is *Latitude's* annual Mexico-Only Crew List and Ha-Ha Party, September 9. There, hundreds of potential crew mix and mingle with Ha-Ha boat owners looking for extra watch-standers. Get a headstart on the process at our constantly updated Crew List site at [www.latitude38.com](http://www.latitude38.com). As many Ha-Ha vets will confirm, the best way to prepare for doing the event in your own boat is to crew for someone else first.

### IS THE PACIFIC PUDDLE JUMP IN YOUR FUTURE?

For many cruisers, the next logical step after cruising Mexican waters for a season or more is to hang a right and head west into the Pacific.

We call that annual springtime migration the **Pacific Puddle Jump**, and report on it heavily in the pages of *Latitude 38*. Making that 3,000-mile passage is one of the most thrilling accomplishments in the realm of sailing. Learn more at [www.pacificpuddlejumps.com](http://www.pacificpuddlejumps.com).

### Ventura Harbor Boatyard, Inc.

Located halfway between San Francisco & San Diego

Haulouts to 165 tons ~ Full line of marine services  
Dockside services ~ On-site chandlery

1415 Spinnaker Drive, Ventura, CA

 (805) 654-1433 • [www.vhby.com](http://www.vhby.com) 



Not just a marina – a cruiser's community  
Your best destination across the Sea...

[www.marina-mazatlan.com](http://www.marina-mazatlan.com)

011-52 (669) 669-2936 & 2937  
elizarraga@marinamazatlan.com



Survive Your Dream

**ECHO Tec Watermakers**

604-925-2660 [www.hydrovane.com](http://www.hydrovane.com)



A Full Service Boat Yard in Puerto Vallarta  
88 ton Travelift • Parts • Service • Repairs

011-52 (322) 221-1800 [www.opequimar.com](http://www.opequimar.com)  
info@opequimar.com



**Sausalito Marine  
Electrical Shop**  
"The Project Place"

Are your electrical, electronic, communication and safety systems ready for Baja and beyond?

CONSULT WITH A MASTER ELECTRICIAN  
Design - Sale - Service

300 Harbor Drive, Sausalito, CA (415) 332-9030  
[www.sausalitomarine.com](http://www.sausalitomarine.com)





**ULTRA ANCHORS** - The quickest setting, highest holding power anchors available for you, your family and your vessel's safety.

Marine Products from the World to the USA



**QuicklineUSA**

15561 Computer Ln, #A, Huntington Beach, CA 92649

714-843-6964 714-843-6906 fax

[www.quickline.us](http://www.quickline.us) or [info@quickline.us](mailto:info@quickline.us)

**FilterBOSS  
COMMANDER**

"Don't Leave Shore Without It."

A complete fuel maintenance system



[www.KTISYSTEMS.com](http://www.KTISYSTEMS.com)

(800) 336-0315

**MARINA DE LA PAZ**  
FULL SERVICE MARINA

Conveniently located downtown

Tel: 011-52 (612) 122-1646

Fax: 011-52 (612) 125-5900

email: [marinalapaz@prodigy.net.mx](mailto:marinalapaz@prodigy.net.mx)

[www.marinadelapaz.com](http://www.marinadelapaz.com)

**KATADYN**  
MAKING WATER DRINKING WATER

Watermakers that improve the cruising lifestyle.

(800) 755-6701 • [www.katadyn.com](http://www.katadyn.com)

email: [marine@katadyn.com](mailto:marine@katadyn.com)

OD36887

**Cruise with Confidence**

See Our Half-Page Ad In This Issue

(800) 992-4443

[www.marinersinsurance.com](http://www.marinersinsurance.com)

**MARINERS**  
GENERAL INSURANCE GROUP

Newport Beach, CA • San Diego, CA  
Burlingame, CA • Seattle, WA  
Bradenton, FL • Puerto Vallarta, MX

**IMPORTANT DATES**

**Sep 9** — Mexico-Only Crew List and Baja Ha-Ha Party, Encinal YC in Alameda; 6-9 pm.

**Sep 10** — Final deadline for all entries.

**Oct 18** — Ha-Ha Welcome to San Diego Party, Downwind Marine, 12-4 pm. Ha-Ha entrants only.

**Oct 24** — Informational Meeting about the Pacific Puddle Jump, West Marine, San Diego, 5 pm.

**Oct 25, 9 am** — Final deadline for all crew and skipper waivers, West Marine, San Diego.

**Oct 25, 11 am** — Skipper's meeting, West Marine, San Diego. Skippers only please.

**Oct 25, 1 pm** — Ha-Ha Halloween Costume Party and Barbecue, West Marine, San Diego.

**Oct 26, 11 am** — Start of Leg 1

**Oct 31, 8 am** — Start of Leg 2

**Nov 4, 7 am** — Start of Leg 3

**Nov 6** — Cabo Beach Party

**Nov 7** — Awards presentations hosted by the Cabo Marina.



[www.downwindmarine.com](http://www.downwindmarine.com)

2804 Cañon St., San Diego

(619) 224-2733 • (800) 269-0241



[www.sandiegomarine.com](http://www.sandiegomarine.com)

2636 Shelter Island Dr., San Diego

(619) 223-7159 • (800) 336-7369

Mexico 001-500-336-7369



[www.sailingsupply.com](http://www.sailingsupply.com)

2822 Cañon Street, San Diego

(619) 225-9411 • (800) 532-3831



**Sea of Cortez:  
A Cruiser's Guidebook**

The most up-to-date, accurate cruising guide detailing the remote and pristine anchorages of the Baja Peninsula and Sea of Cortez.

[www.exploringcortez.com](http://www.exploringcortez.com)

Blue Latitude Press

**Yachtfinders/Windseakers**  
in the heart of  
San Diego's boating community

Specialists in cruising sailboat brokerage for 27 years

[info@yachtfinders.biz](mailto:info@yachtfinders.biz) • [www.yachtfinders.biz](http://www.yachtfinders.biz)

(619) 224-2349 • (866) 341-6189 toll-free

Fax (619) 224-4692

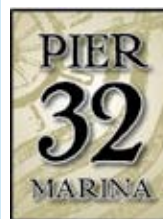

Enjoy a free night on us and a pre Ha-Ha party too!

Cruiser friendly with a helpful staff.

(800) 729-7547

(619) 477-3232

[office@pier32marina.com](mailto:office@pier32marina.com)

**Baja Ha-Ha Inc.**

c/o 15 Locust Ave.

Mill Valley, CA 94941

[WWW.BAJA-HAHA.COM](http://WWW.BAJA-HAHA.COM)

PLEASE NOTE: There is no phone number for the Baja Ha-Ha Rally Committee.

Please don't call *Latitude 38* with questions. The Ha-Ha is a separate operation.



A Sailor's  
Consignment  
Chandlery

(510) 769-4858

Located at Grand Marina

[www.bluepelicanmarine.com](http://www.bluepelicanmarine.com)



# TRADITIONAL VALUES

**T**hink you need to have a new boat, a ton a money, and to be young to enjoy a very lengthy cruise to the 'old world' and back? You don't. Not if Paul and Annalise Pedersen of the Vancouver-based *Sea Lise* are any indication.

*The couple found they could cruise on \$1,250 a month, everything included.*

Twice last month we visited with this lovely couple as they were in the last stages of their 11-year 'return to their roots' cruise from Vancouver to Denmark and back. Among the things that 74-year-old Paul said they learned was that their 28-year-old *Islander 36* — with equally old sails and diesel — was just fine for the task, and that they could cruise on \$1,250 a month, everything included. "And sometimes even less than that," added Annalise.

The Pedersens are a classic old school immigrant success story. Fifty-two years ago, Paul, then 21, who didn't speak English, arrived in Canada with his 17-year-old bride Annalise, two-month-old daughter, and just \$200 to their names. A man who believes in taking care of himself and his family rather than having the government do it for him — as is done in his native Denmark — Paul had no problem carving out a good life in his adopted country. Having already worked

since age 14, once he arrived in Canada he worked in a uranium mine, became a car mechanic for 10 years, and spent the last 26 years of his working life as a shipwright doing emergency repairs. In his last job, he took all the overtime he could, and was able to retire six years early.

Through a combination of working hard and being thrifty, the couple have not only been able to afford a very nice home, but Paul has been able to sail his whole life. Characteristically, he started with small boats that he built himself — two 8-ft Sabot dinghies, then two 16-ft Fireballs — before getting into 29-ft Dragons, a popular racing class in Europe. After owning a C&C 35 racer/cruiser for several years, in '91 Paul's sister talked him into buying her Marina del Rey-based *Islander 36*.

When it came time to go cruising in August of '98, the Pedersens had a definite purpose. "Our goal was to return to Praesto, which is about 45 miles south of Copenhagen, and where I sailed as a kid," says Paul. "There, we would see all our family and friends from the old country." The couple had a baptism by fire

early on, when it blew 35 to 40 knots for 12 hours off the coast of Oregon. Pedersen said they only had three cases of bad weather in their 11 years of cruising, and the stuff off



the Oregon coast was the worst. But thanks to his extensive sailing background, he wasn't scared on that occasion, or at any other time during their travels.

**T**he couple took their sweet time getting to Denmark. "We spent two seasons in the Sea of Cortez, which we liked

## CRUISING TIPS FROM AN OLD SALT

*Because Paul is an accomplished racer and cruiser who is confident in his opinions, we decided to pick his mind on a variety of random subjects:*

- "My racing experience was a huge plus in enjoying our cruise, because I had complete confidence in what our boat and I were capable of. If the skipper of a cruising boat feels uneasy — which is not uncommon — the crew feels uneasy, and then nobody relaxes or has a good time. While you have to know your limitations and your boat's limitations, you can't ever be afraid, because if you are, you lose half your abilities."

- "We love our *Islander 36*, as she's well-built, very forgiving, can take a lot of wind, and has a protected rudder and a lead keel. Before leaving, I beefed up her rigging, replaced the forestay, added an inner forestay, running backs, a storm jib, and steps both up to the first spreader and at the top of the mast."

- Paul also outfitted *Sea Lise* with two main halyards, two jib halyards and two spinnaker halyards. "I also changed

the sheave to as wide a one as possible for rope halyards. This was critical for reducing wear. In addition, there must be at least 12 inches between the headboard of the main and the sheave or the halyard will fray. After 11 years of cruis-

ing, all our halyards still look great."

- "Having known of two boats with rope/chain rodes that were lost on beaches, we're happy to have all chain. We carry a 40-lb Bruce anchor at the end of 240 feet of chain. We also carry a 45-lb CQR and a Danforth."

- *Sea Lise's* windlass broke down

shortly before they left Denmark two years ago, but they never had time to fix it. But no worries, as Paul just raised the anchor by hand. "It's not that bad," says the 73-year-old, "and it kept me in shape."

- Unlike most cruisers, the

*There's nothing fancy about 'Sea Lise' but she's served the Pedersens well everywhere they traveled — even above the Arctic Circle.*



# — 11 YEARS ABOARD SEA LISE



LATITUDE / RICHARD

**Paul and Annalise don't go in much for the Socialistic tendencies of their native Denmark. They prefer to take care of their own needs.**

very much," remembers Paul. "Then we made our way down to and through the Canal, later stopping at Isla Mujeres and Florida's Dry Tortugas — which we thought were wonderful. It was

Pedersens didn't live and die by GRIB weather files. "We got weather reports via HAM and SSB and from other cruisers. While in Europe, we got it from local radio stations."

- They started with a Fleming wind-vane, but switched to a Monitor. "For two years I couldn't get the Monitor to work right, but then Hans, the owner of Monitor, explained what I'd been doing wrong. Once you learn how to set it, it's wonderful. In fact, I rate it as more important than the radar — although I have a radar, too. And by the way, somebody bought our Fleming, and it's worked great on their boat, too."

- *Sea Lise* is equipped with both a wind generator and five solar panels. "As long as we didn't watch too much television, these green energy sources provided for all our electrical needs. In fact, prior to tying up to the police dock in San Diego in June, we hadn't plugged into shorepower in six years. We never

plan was to cruise six months a year, then return home for six months a year in order to stay in contact with children, grandkids and friends. Paul and Annalise spent the next season cruising as far south as Georgetown in the Bahamas, before returning to Florida and taking the IntraCoastal Waterway up to the

plugged in while in Denmark because the electricity is so expensive — six times what it costs in Canada! In fact, the cost of heating a boat in Denmark is more expensive than the slip itself. Of course, the *Islander* was made for California and therefore isn't well insulated for northern latitudes."

- "We had no significant gear failures. I did have to change the starter for our 28-year-old Volkswagen diesel once, but it was actually a wiring problem. Our engine ran great and, despite its age, didn't smoke or use oil. I did, however, change the injectors once."

- The couple used a two-bladed fixed prop until two years ago, at which time they replaced it with a Flex-o-Fold three-bladed prop. "It eliminated the vibration we had before."

- "Our Nova Cold refrigeration system needs to be replaced after 12 years, as the compressor won't shut off. The good news is that the new ones only use 60%

while sailing up to Florida from Panama that the couple had their second bout of bad weather. "It blew 20 to 25 knots on the nose for three days," says Paul, who would be the first to admit it wasn't that bad at all.

After putting the boat on the hard in Florida, the couple drove their VW bus back to Vancouver for the summer. Their general

Chesapeake Bay. Paul was happy to find a place in Deltaville, VA, where they could leave the boat for just \$65/month over the winter.

It was in the summer of '03 that the Pedersens took a somewhat unusual — and chilly — route across that Atlantic. Departing from Hampton, Virginia, they bypassed both Bermuda and the Azores to sail east at 50 degrees north. Twenty-eight days later, with Paul having stood all the night watches, they made landfall at Falmouth, England.

"We had heavy fog for the first 10 days of the crossing," remembers Paul, "but then we enjoyed pleasant trades the rest of the way across. Surprisingly, we never

*"We only had three instances of bad weather in 11 years."*

had more than 18 knots of wind, and no big seas. It was wonderful!" Despite the calm seas, the Pedersens put all the cushions on the cabin sole and slept on them. The lower center of gravity meant they rocked and rolled less.

After sailing up the English Channel, the two continued on through the Kiel Canal to Praesto, Denmark, where they were greeted by a cheering crowd of family, friends and newspaper reporters. They would spend the next three summers in the region.

of the power of our current model."

- "The one thing we didn't have that I would like to have had was inboom furling. That's because the most dangerous times for me — and therefore us — were when I had to be on top of the cabin house flaking the main."

- "The *Islander 36* was a very manageable size. I could probably handle a 40-footer, but at my age I would probably consider an electric winch for the main and sheets."

- "One of the big lessons I learned was to make sure to reef in time. And that it's often better to put in two reefs rather than one."

- "The secret to being able to do such a cruise on \$1,000 a month — including doing things such as buying a dinghy and outboard — is that I do all my boat work myself." It doesn't hurt, of course, that Paul was a mechanic and a shipwright for many years.

— latitude



# TRADITIONAL VALUES

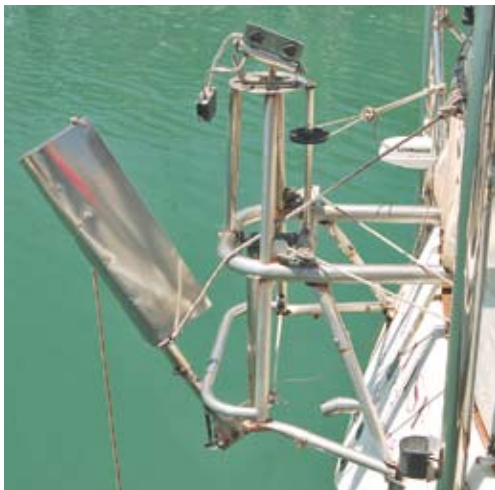

**Left to right: The Monitor windvane is a valued asset; masthead steps are smart; the windlass has long sat idle; the pressurized \$10 shower.**

"The first summer we sailed around Sweden, Finland, Estonia and the Osland Islands, near Iceland," says Paul. "We really liked Stockholm because it was so much like San Francisco and Vancouver." Except for three weeks at the height of the short summer in the high latitudes, it was long-sleeve shirt weather. They spent that first winter on

the boat — despite the fact that the average high temperatures for the months of December, January and February are less than 40 degrees. "At times our boat was surrounded by two inches of ice!" remembers Paul.

Paul and Annalise cruised the west coast of Norway to Bergen in the summer of '05. When they got to a rock promontory called the Preacher's Chair, Paul decided to climb the world's longest wooden stairway — 4,400 steps. It took

him 3.5 hours to get to the top, where he was rewarded with a fabulous view, and 2.5 hours to get back down.

The couple kept their boat in Denmark during the summer of '06, but spent most of their time touring by car. They drove an astounding 48,000 miles, most of it in Germany.

Having spent quite a bit of time in Denmark, Paul found his native country to be much too socialist for his liking. He cited three objections. "First, they think



**HYDROVANE**  
SINCE 1968

Celebrating  
40 Years of  
Excellence

**Survive Your Dream**

Latest Arc Survey - Hydrovane again  
rated most popular wind vane.



Polar Circumnavigator  
Adrian Flanagan

YACHTING

MONTHLY October 2006

100 YEARS OF  
YACHTING  
SOCIETY

100

best bits of gear - ever!

HYDROVANE included twice!

Official  
Sponsor

2009  
BAJA  
HA-HA

HYDROVANE IS BOTH:

- ★ Self Steering
- ★ Best Emergency Rudder

SHOWERS EVERY DAY!

ECH<sub>2</sub>O Tec Watermakers

BUILT TO LAST!

www.hydrovane-watermakers.com

www.hydrovane.com
604-925-2660
info@hydrovane.com



## McGinnis Insurance

Since 1972

Knowledge Commitment

Reliability Service



Large and small, we do them all!

Call us at: **800-486-4008**

mcginnisins@aol.com

License #0570469

# — 11 YEARS ABOARD SEA LISE



LATITUDE / RICHARD

that everybody should have just as much as everybody else — even though one person is willing to work hard and the other is lazy. Second, the taxes are too high. Sure, everyone gets to retire at 58 at 90% of

their wages, but they have to pay 35% tax on it — in addition to countless other taxes. While in Denmark we paid \$40 for a bottle of propane that cost us just \$10 in Canada — all because of taxes. And if you buy a fuel efficient diesel car, the government slaps you with double the road taxes so they are no more economical than gas cars. Third, there is a lack of personal freedom in Denmark. It doesn't matter if you want to change a door or put in a garden shed, you have to ask

permission from the government."

Although Paul admits his brother, who still lives in Denmark, loves the system, he can't stand nanny governments. "When it comes to finances, I can do a much better job of taking care of myself than the government can. From the time I started working, I always set aside 10% of my earnings. That resulted in my wife and I being able to own a very nice home, my being able to sail all my life, and my wife and I being able to do this wonderful cruise. And we're not done cruising, as we'll probably sail up to Alaska next summer."

*"We had to make a 30-hour detour in order to sail past the famous Fastnet Rock in the Irish Sea."*

continuing on to Spain, we had to make a 30-mile detour in order to sail past famous Fastnet Rock," says Paul. "It was very impressive."

The Bay of Biscay is notorious for rough weather, and the Pedersens caught some of it. But once again, it wasn't that bad. "We actually didn't have any wind for the first two nights in the Bay of Biscay, but then it blew up to 35 knots

for about 30 hours. It could have been worse, but we were broad reaching. Then finally, out of the mist, we saw all the windmills on the hills of Spain. We spent three weeks in Spain, and

while in Lisbon bumped into John and Amanda Neal of the well-known Friday Harbor-based Hallberg-Rassy 46 *Mahina Tiare*."

The couple continued on to Porto Santos, Madeira, then down to the Cape Verdes off Africa before beginning their second Atlantic crossing. "We covered

On July 1 of '07, Paul and Annalise sailed across the North Sea to Scotland and the Caledonian Canal, then on to Dublin and Kinsale in Ireland. "Before



MARINA RIVIERA NAYARIT  
AT LA CRUZ  
*El sueño hecho marina*

## Full Service Marina

- Offering a splendid combination of amenities such as:
- With up to 400 vessel capacity from 30 to 400 ft.
  - Pump out • Diesel and Gas fuel station • High quality and comfort in all slips • Power 110, 220 y 440 volts
  - Ship yard with Travel Lift up to 150 tons capacity • Restrooms • Showers • WiFi • Security 24/7
  - Restaurant (IKUAL) • Bar (TAIKAI) • Deli (KITSIURI) • Yacht Club (ETUPA) • VIP lounge (business center) • Open air theatre (XIRIKI) • Electric cars transportation

[www.marinarivieranayarit.com](http://www.marinarivieranayarit.com)

info@marinarivieranayarit.com / Tel. (011.52) 329 295.5526 / MARINA COORDINATES: LAT. 20° 45'N / LON. 105°24'W





# TRADITIONAL VALUES

the 2,250 miles to Barbados in 14 days and 10 hours, having sailed wing-on-wing the whole way, and having never needed to touch the wheel. It was the best sailing we had on our cruise." A 150-mile-a-day average for two weeks on a 36-ft boat sailing wing-on-wing — very impressive.

After calling on most of the islands in the Lesser Antilles, the couple put the boat on the hard for the summer of '08. Earlier this year they left Cartagena for the Canal. It was in Panama that they had their only significant bad incident. "It was really our fault," says Annalise, "for as we were getting out of the taxi, we left a bag of groceries and a bunch of personal stuff — wallets, passports, new glasses and all our addresses — on the back seat. While we were still getting ourselves organized, the driver pulled away. It cost us about \$2,000, and took us a week to get new passports.



LATITUDE / RICHARD

***With their solar panels and wind generator, the Pedersens hadn't hooked up to shore power in years before getting back to San Diego.***

After the Canal, the couple motored all the way to California — where they had something stolen from their boat for the first time. After they had tied up at a guest berth in the Santa Barbara Yacht

Harbor and gone off to get some dinner, someone broke into their boat and stole their two-day old camera. Rather than being upset, the couple were more amused that they'd been ripped off in Santa Barbara as opposed to somewhere in Colombia, the Bahamas or Central America.

So will they swallow the anchor once they make it to Vancouver? Not on your life. Paul is anxious to race with his daughter because *Sea Lise* has an unused set of sails that were made 11 years ago, and will earn him and her a big ratings handicap. Paul never bent on the new sails during their cruise

because the now-28-year-old main and 35-year-old jib were still serviceable.

And come summer, the couple are likely to cruise up to Alaska. Although Annalise frowns a little when she hears it, Paul says, "I could live on a boat forever. But never a powerboat."

— **latitude**/richard

At **\$4.50 a foot**, the **Aeolian YC** offers some of the best priced berthage in the Greater San Francisco Bay Area. We currently have 7 moorings available: a 40' side tie, a 35' side tie, three 32' slips, and two 28' slips. The marina space is fully serviced with water and electricity and offers a large workshop area with private tool lockers for rent. Join us as we enjoy a full social calendar, cruise-outs, Friday nights in the upstairs bar, plenty of room for BBQs and relaxing on the back porch. See our web site at [www.aeolianyc.com](http://www.aeolianyc.com) for more information and to download a membership application.



<b>Contact:</b>	Dave McDaid	(510) 305-7985
<b>Location:</b>	Aeolian Yacht Club	(510) 523-2586
	980 Fernside Boulevard	Alameda, CA 94501
	aeolianyc@aol.com	www.aeolianyc.com



**ESSEX  
CREDIT**

NEW - USED - REFINANCE

# Boat Loans Made Easy®



Let our 27 years of experience go to work for you!

**Richard Tressler**  
866-377-3948 ext. 47008

[www.essexcredit.com](http://www.essexcredit.com)

EQUAL CREDIT OPPORTUNITY LENDER

Loan Amounts from \$15,000      Instant Loan Approvals\*  
Zero Down Program\*              90 Days to First Payment\*

\*(Subject to Loan Program Guidelines and Credit Approval)

Reference Code =MAR931



## MARINE INSURANCE SPECIALISTS

**Your best source for Yacht and Boat Insurance  
tailored to your needs and competitively priced**

### We Insure:

Sail or Power ♦ Classic or Contemporary  
Fiberglass ♦ Aluminum ♦ Steel ♦ Wood

At Heritage Marine Insurance you will find knowledgeable insurance professionals who provide the best service and the finest coverage available today.

*Please contact us for a quote*

[www.heritagemarineinsurance.com](http://www.heritagemarineinsurance.com)

**800-959-3047**

Fax 860-572-5919

Email: [classics@heritagemarineinsurance.com](mailto:classics@heritagemarineinsurance.com)



**BLUESTORM**

## Prepare for the unexpected



Bluestorm Inflatable PFDs provide the ultimate in style, safety and value.

- Three sailing models with built-in harness
- Manual, fully automatic, or convertible inflation
- USCG approved

Bluestorm  
P.O. Box 210  
Plympton, MA USA  
(877) 688-5657  
[www.bluestorm.us](http://www.bluestorm.us)



# MAX EBB

**W**e were up on the race deck waiting for the first finishers and having the same conversation heard in yacht clubs all over the world: Which is faster? A giant trimaran with foils or a giant catamaran with power winches?

"I hate to say this, but I have to go with the cat," concluded one of our club's more experienced multihull racers as he scanned the last leg of our local race course with binoculars. "Given any two multihulls of equal size, the cat is always the faster boat."

"Ah, but the sizes are not really equal," added another sailor, a retired ocean racer who now owned a very large cruising catamaran. "The tri has a bigger rig and longer overhangs, and it will put them in the water when it heels."

"We don't really know if the tri is bigger," added a third expert, a lawyer who races a fast monohull sportboat.

"But think of all the extra development time that *Oracle's* had," said the cat owner. "*Alinghi* is playing catch-up."

"Not really, *Alinghi* has been working on multihulls for just as long, maybe longer, if you count their 40-footers."

"*Oracle* still has the bigger, heavier and more powerful machine, and more time to get it debugged."

"Remember what happened in '88?" asked the cat racer. "Conner beat off the surprise Deed of Gift challenge with a cat that was only half as big as the New Zealand monster monohull. It could happen again. Even under a straight Deed of Gift challenge, the defender moves last, and has the advantage."

"I just wish they'd get back to normal America's Cup racing," sighed another cruiser between sips of beer. "All this legal stuff is ruining the America's Cup."

We really didn't need this many people just to finish a club race, but RC volunteers get to run their afternoon bar tab on the race committee account, and sometimes there's a free lunch, so race deck duty tends to attract a few freeloaders.

"I lost interest when the first lawsuit was filed," continued the cruiser, "and now we're going to have two completely different boats in the match, if there even is a match. No one's interested in watching this travesty."

"Objection! Lacks foundation!" shouted the lawyer, pretending his witness was being unfairly cross-examined. "Read up on your America's Cup history. A bitter legal fight and two different state-of-the-art boats is what the America's Cup has always been about. Right from that day in 1851 when the original *America* was launched, there was a dispute over the yard bill, and it's been the protests, the

legal actions and even the mismatched boats that have kept this race in the pages of the *New York Times* for 158 years. Otherwise the America's Cup would be just another sailboat race, and everyone would have forgotten about it a hundred years ago."

"And for us propeller-heads," added the catamaran racer, "this is the most exciting challenge since '88. There's actually something interesting to read about the boats for a change, from a techie point of view. Even if you don't like to read those legal blow-by-blow updates by Cory Friedman on the net."

"Cory does great legal writing, if I say so myself," said the lawyer.

"I still say this should be about sailboat racing," insisted the cruiser as he headed to the bar for a refill.

"You know, he does have a point about the match itself not being very interesting to watch," said the cat racer after the cruiser had gone downstairs. "Even the fastest boats in the world are pretty boring after an hour of essentially similar visuals. Sure, we were all glued to the TV for the last A-Cup, but that's

mostly for the novelty of seeing sailing on the tube."

"And the novelty of a close Cup race," I added.

"Even with close racing, do you really think you'd watch sailing every week?" said the cat racer. "We'd all be looking for the remote to see what else was on before they get to the first mark."

"Good point," I agreed. "I wouldn't miss the first crossing of *Oracle* and *Alinghi*. But after that? Might as well switch to the Grass Growing semi-finals."

"And when all the boats look identical," said the cat racer, "there's not even a technology display to hold my interest. Boring."

**W**ith the complaints of the cruiser far outnumbered by the enthusiasm of the racers, and no finishers in sight, the group continued to debate the outcome of the upcoming match. We concluded that in light air the *Alinghi* cat will probably be faster, at least in a straight line, mainly due to its light weight. But the cat will lose a lot on each tack, and that

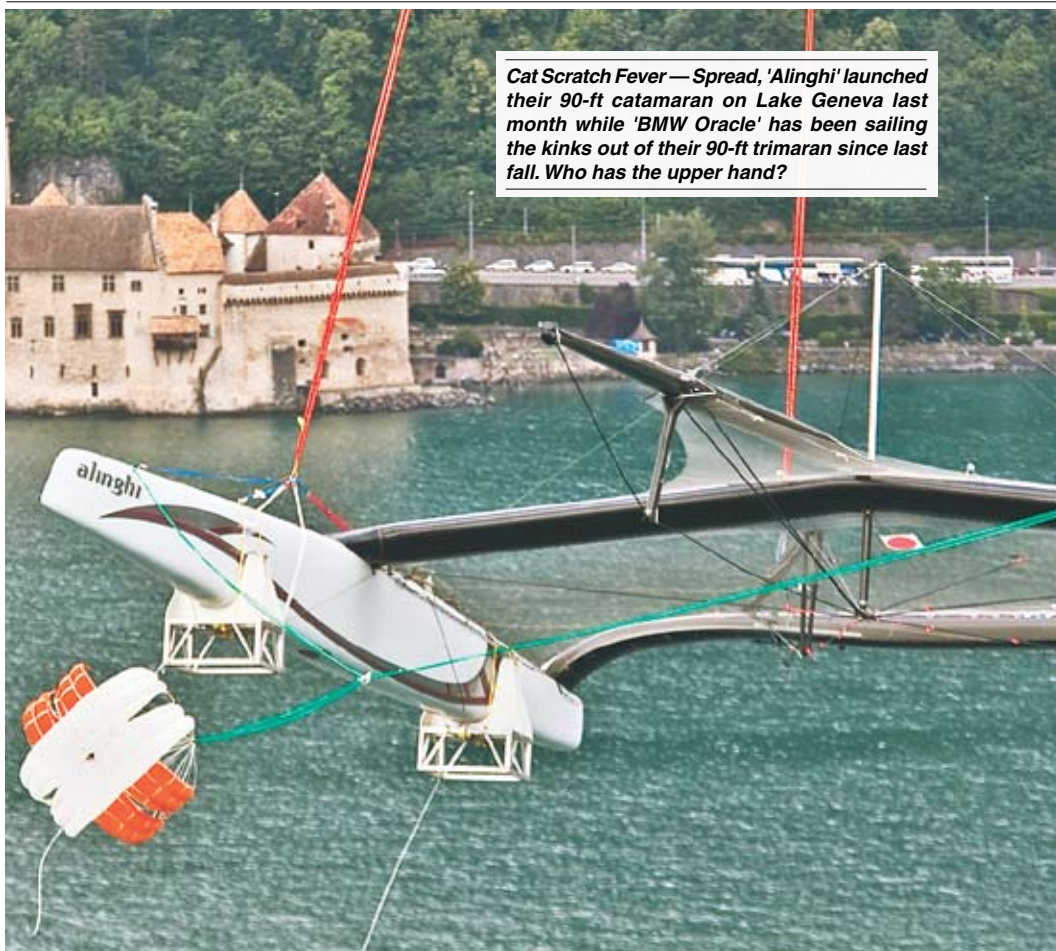

**Cat Scratch Fever**— Spread, *'Alinghi'* launched their 90-ft catamaran on Lake Geneva last month while *'BMW Oracle'* has been sailing the kinks out of their 90-ft trimaran since last fall. Who has the upper hand?

STEFANO GATTINI / ALINGHI

# THE BEST A-CUP EVER

might cost it the match if wind conditions are shifty. The *Oracle* tri will dominate when the wind is strong enough for it to be foil-borne.

Lee Helm, a naval architecture grad student with more technical chops than all the other pundits put together, was keeping uncharacteristically quiet on the issue. She was busy enjoying a free lunch from the snack tray that had been sent up from the kitchen.

"Not enough info at this time," she insisted. "No predictions till I, like, see some numbers. But speaking of 1988, I did some research and found a paper by Burt Rutan, that aerospace guy who builds private-sector spacecraft. He also built the wing sail for Conner's defending cat. It's, like, counterintuitive, but the solid wing sail turned out to be lighter, more reliable and easier to trim than the soft sail rigs they tested."

"That does sound backwards," I said.

"Totally. But think of what happens to a soft sail at very low angles of attack. I mean, you can't push out against the pressure difference with a soft membrane, and that's what most of the front part of an airfoil has to do. I think the team that gets its act together with the rigid wing is the one that will have the faster machine."

"But I'm not convinced that bigger is faster when we're talking multihulls," said the cat racer. "Look at all the windsurfers breaking speed records."

"The scaling still favors the big boats," said the cruising cat owner. "Think of it this way: Compare two cats, one twice as big as the other. The displacement of each hull is proportional to length times hull beam times hull draft. So if each one of those dimensions doubles, then

displacement becomes eight times as big. And the distance between the hulls also doubles, so with one hull just out of the water, the leverage against heeling is 16 times bigger for the cat that's twice as big."

"Scale factor to the fourth power," interjected Lee.

"Heeling force goes up, too," I reminded them.

"Sail area is proportional to mast height times boom length," continued the owner of the big cat, "and each of these doubles when size doubles, so you have

four times as much sail area, and the center is twice as high up, so you have eight times as much heeling leverage."

"Scale factor to the third power," said Lee.

"So the big cat has 16 times as much stability but only 8 times as much heeling. It can handle twice as much wind."

"Um, 41% more wind," corrected Lee. "Square root of two, because wind pressure is proportional to wind speed squared. But, like, you're right, the big boat has an advantage. They can spend some of that extra stability margin in the design phase, with a bigger rig. Also, that's why big cats have an easier time passing the capsizing screening formulas that compare heeling moment to righting moment, like for the Pacific Cup multihull division."

"Except that with these giant multihulls, they might not be limited by stability," suggested the catamaran racer.

"What if both boats are so wide that they just don't come up against stability as a limiting factor? At some point, I think the structural considerations limit the design, and I think a good small cat can be faster than a non-optimized big cat, and both of these monsters are too new to be anywhere near optimized."

"Big still has an advantage," asserted Lee. "Think Reynolds number. Big foils work more efficiently than small ones."

"Reynolds number?" asked the cruiser as he sat down with another drink. "What's that?"

"It's just a non-dimensional index for comparing the importance of inertial forces to viscous forces acting on an object moving through a fluid," Lee explained, as if this were so simple it should be obvious to anyone. "It's proportional to length of the object times speed. If the Reynolds number is, like, very high, foils behave closer to the ideal frictionless condition, and work more efficiently. For boats operating at very low angles of attack, with very high lift-drag ratios required, bigger is going to be way faster than smaller."

"How can length times speed be non-dimensional?" asked the cat racer.

"Good catch," said Lee. "It's really length times speed divided by kinematic viscosity."

"Kinematic viscosity? What's that?" asked the cruiser.

"Viscosity divided by density," said Lee. "Viscosity is the shear stress produced by a velocity gradient in the fluid. It's how much shearing force is in the fluid when there's a unit velocity gradient."

The cat racer was the only one still following Lee, but she pressed on.

"Force is mass times acceleration, or mass-length per time squared. You wanna do this in English or metric?"

"I'll take English units, thank you," the cruiser answered as if this were a quiz show.

"Cool. For shearing stress in the fluid, we need force per area, or pounds per foot squared. A pound is a mass times an acceleration, or a slug-ft/sec<sup>2</sup>, so for shear stress we have slug-ft/sec<sup>2</sup>/ft<sup>2</sup>, which simplifies to slug/(ft-sec<sup>2</sup>). Now divide by velocity gradient, ft/sec/ft, which is the same as 1/sec. You get slug/(ft-sec), and this is the dimension of a unit of viscosity. For kinematic viscosity, divide viscosity by density. Density is mass per volume or slug/ft<sup>3</sup>, so we get (slug/(ft-sec))/(slug/ft<sup>3</sup>). Anyone have the answer?"

The cat sailor was writing on his napkin with a marking pen. It took him a minute to catch up, but according to



GILLES MARTIN-RAGET / BMW ORACLE RACING





# MAX EBB

Lee, he arrived at the right answer.

"Feet squared per second is what I get," he said as he scribbled some more on the napkin. "And sure enough, that's the same units as length times speed, feet times feet per second. I see, the dimensions all drop out when you divide length times speed by kinematic viscosity. Very nice."

"But that's not going to convince any mere mortal that bigger foils are more efficient than small ones," I said.

"Sure it does. You have speed and length and density, if you move density to the numerator. All the factors that produce inertial forces are now on top of the fraction. Divided by viscosity, the viscous or frictional force, in the denominator. So this number compares inertial forces to viscous forces. And it's, like, non-dimensional, so the number is independent of the units chosen."

Even the technically astute cat racer looked confused now.

"Okay, you need the experimental data, too," Lee admitted, "to really see the effect. Bottom line is that big and fast is more efficient."

"I still say all this fooling around is ruining the Cup," repeated the cruiser as he finished another drink. "Bring back the 12-meters. And the boats should be designed and built by the country they represent. And the crew should all be from that country, too."

"Foreign crews were part of the game from very early on," noted the lawyer. "Skippers, too. Without Charlie Barr from Scotland, we probably would have lost the cup in 1899."

"Before everything went global," said Lee, "there was something to be said for a match that compared the design technology of one country against another's. I mean, we can't turn the clock back on that one, but it would be awesome to institute some really tough crew and afterguard nationality restrictions. You know, like 10- or 15-year residency and citizenship. That would sort of replace the lost national identity of the technology with the national identity of the crew."

"I'll drink to that," said the cruiser. "Of course then the Kiwis would always win, everything else being equal," said the big cat owner.

The first group of finishers in our race came into view, and we had to get to work firing guns, blowing horns and writing down times and sail numbers.

"*Alinghi* will be DSQ'd for using power winches, even if they do sail faster," said the cat racer after a lull in the action. "Most likely it'll be back in the courts for another few months before we have the final outcome."

"No, please, no more court battles," groaned the cruiser.

"I can hardly wait to read the summaries," said the lawyer.

"I want to see if *Oracle* can retrofit power winches, if the rules change," said the cruising cat owner.

"I just want to see *Oracle* fully foiborn at 40 knots," said the multihull racer. "This is turning out to be the best America's Cup ever!"

— max ebb

COVER CRAFT

Make your boat  
**DRY,  
COMFORTABLE  
& ROOMY**

with a dodger from Cover Craft



All sewing in Tenara thread

"Bringing the boat to you was the best investment we've made in a long time."

1230 Brickyard Cove Road, #106  
Pt. Richmond, CA 94801  
In Brickyard Cove Marina

**(510) 234-4400**

Quality  
Yacht  
Canvas

## COAST MARINE

& INDUSTRIAL SUPPLY INC.

398 Jefferson St. San Francisco - On the Wharf.

Call Bruce Becker or Clark Atkinson  
(415) 673-1923 (415) 516-4860

800-433-8050  
Fax (415) 673-1927



**LIFE RAFT**  
Sales & Service

U.S.C.G. Approved Testing Facility

- ★ U.S.C.G. life raft facility for Solas commercial yacht and fisherman rafts
- ★ COMAR DEBARKATION LADDERS
- ★ COMAR PILOT LADDERS
- ★ COMAR WORK LADDERS
- ★ All U.S.C.G. approved

**GUINNESS** "World's longest tested ladder 320ft."  
WORLD RECORD



Major Distributor for:



**Pains Wessex**  
Safety Systems



**STEARNS**



IN SAN DIEGO CALL OCEANS WEST 619 544-1900



*City by the Bay*

# deWitt

*For Custom Prints  
of any of Jim's work,  
call Pam at...*

**DeWitt Art Gallery & Framing**

121 Park Place  
Point Richmond, CA 94801

**(510) 236-1401**

**(800) 758-4291**

[www.jimdewitt.com](http://www.jimdewitt.com)

[www.dewittgalleryandframing.com](http://www.dewittgalleryandframing.com)

Tuesday-Thursday 11:00-5:00

Friday 11:00-3:00 • Saturday 12:00-5:00

**SAUSALITO**

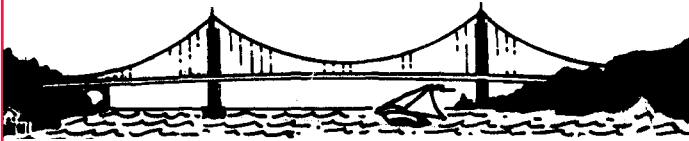

**LIST MARINE INC.**

- Full service engine shop
- We service all makes
- Dockside facilities
- Mobile service trucks



**YANMAR**  
marine 

P.O. BOX 2008 / 69 LIBERTY SHIP WAY • SAUSALITO, CA 94966  
Adjacent to Schoonmaker Pt. Marina

**415•332•5478**

[www.listmarine.com](http://www.listmarine.com)



**Lowrie  
Yacht  
Harbor**  
INC.

**(415) 454-7595**

  
**ANCHOR**  
BOAT SALES

**(415) 257-BOAT**

- **\$6.50** per foot – Best Rates this side of the Bay
- 25' - 65' Berths Available – North Bay/Marin Co.
- Surge and Wind Protected – Out of the Fog
- Convenient Location – Warm and Sunny
- Family owned since 1948 – Friendly Staff

**40 Pt. San Pedro Rd., San Rafael, CA**



# THE RACING

Not even a traditionally under-scheduled Fourth of July weekend could put the brakes on the month's racing schedule. We start off with a recap of the **Express 27 Nationals** in Santa Cruz, then we check in with some Southern California action at a breezy **Ullman Sails Long Beach Race Week Presented by Acura**. After that gain a little elevation and check in with the **46th Annual Trans-Tahoe Race**. Next up is the resurgent PICYA **Lipton Cup** and then the only regatta we know of with a "T"-mark — the Bay View Boat Club's **Plastic Classic**. Finally, there's a quick look at the **Boreas Race** and **El Toro Jr. North Americans** followed by a few **Race Notes**. Enjoy!

## Express 27 Nationals

After a one-year hiatus, Scott Parker returned to the Express 27 Nationals, hosted by Santa Cruz YC July 10-12, and won the event for the first time by a comfortable 10-point margin.

With Santa Cruz Sails' Dave Hodges calling tactics and Anne Alward — who last year sailed aboard winner *Shenani-gans* — Doug Kirk and Dave Kelly working the rest of the boat, Parker's *Freaks ona Leash* counted four bullets over the course of the nine-race series.

The Bay Area-based, Richmond YC member counted only one finish outside the top-four and led the 12-boat fleet for the entire regatta after winning the distance race — from outside Santa Cruz Harbor to Natural Bridges and back, twice around — on the first day.

"We figured out we have well over 100 years of sailing experience among the five of us," Parker said. "Hodges is a really good tactician. Having him on board allowed me to just concentrate on driving, and we didn't have to worry about sail handling."

J/105 fleets, often sailing with the other 'Freaks.'

According to Parker, the breeze was up on Friday and Sunday and more moderate on Saturday. That variety didn't seem to bother them, as they posted a win on all three days.

Last year's season champion, Tom Jenkins' Morro Bay-based *Witchy Woman* was second followed by Jason Crowson's *Moxie* in third.

## EXPRESS 27 NATIONALS (6/12-14)

OVERALL — 1) *Freaks ona Leash*, Scott Parker, 15 points; 2) *Witchy Woman*, Tom Jenkins, 25; 3) *Moxie*, Jason Crowson, 31; 4) *Discotheque*, Echeyde Cubillo, 33; 5) *New Wave*, Buzz Blackett. (12 boats)

Complete results at [www.express27.org](http://www.express27.org)

## Ullman Sails Race Week Presented By Acura

Right up through Dave Ullman's weather and strategy briefing prior to Friday's first race, it was looking like the 2009 Ullman Sails Long Beach Race Week Presented By Acura June 26-28, was going to be a light-air affair. Fortunately for

the 132 boats in 18 classes, the breeze filled to the mid-teens the first day, built to high teens on Saturday, and was starting to look a lot like San Francisco Bay — breeze in low 20's and big chop — on Sunday.

With a little chaos and carnage on Sunday — there were several wrapped kites and more than a few roundups — it was an awesome regatta.

San Francisco's Drew Harper and his *BoomSlang* crew — Garret Greenhalgh and Mahalynn Lu — took full advantage of the familiar conditions, posting three bullets and two seconds to run away with



RALPH DEEDS



RALPH DEEDS

'Freaks ona Leash': Dave Kelly, Doug Kirk, Dave Hodges, Scott Parker, Anne Alward. Shore crew Robbie Hodges only has eyes for Alward...

It wasn't their first time sailing together either. Parker said that in addition to sailing on Hodges' Farr 38 *Timber Wolf* in the SSS events, he splits his time between the *Wabbit*, Moore 24, and

the *Viper 640* division — the first-ever one design start at Race Week for the emerging fleet.

"I had always wanted to sail Long Beach Race Week," Harper said. "It was even better than I expected. More Bay Area sailors should make the trip. It's an easy drive down to the southland; and both Alamitos Bay YC and Long Beach YC go out of their way to make this a cornerstone event for the West Coast."

The small sportboats were out in full force this year; the Open 5.70 fleet boasted its largest-ever stateside one design start as the second largest one-design fleet at Race Week. Four of the 11 boats on the line hailed from Northern California — Paul Dorsey's *DiabolicLRB*, Bruce Runyan's *Rubic*, Kathy Conte's *Boudicca*, and Michael Gough's *Boracic*. Racing with his son Tony, Southern Californian Rich Festa and his *Il havic* ran away with this year's





**Above** — Jason Crowson's 'Moxie' squeaks by the weather mark on the way to a win in Race 7, and third overall, at the Express 27 Nationals in Santa Cruz July 10-12. **Right** — The Deeds family's 'Magic Bus' gets more than a little sideways while in hot pursuit of one 'Wile E Coyote'.

event, collecting 10 points over the seven races and repeating as the class's Pacific Coast Champion.

"Race Week really is the perfect venue and event for our fleet, and ABYC was extremely accommodating," said *Open Sailing's* Jerome Sammarcelli, who took fourth place, with 12-year-old Cooper Weitz as his crew. "It's a real nice mix of very good, competitive sailors and those wanting to have a lot of fun. Our entire fleet had a fantastic weekend and really enjoyed ourselves."

There was no deviation this year from the Race Week program of two windward/leeward buoy racing courses near the breakwater and one random leg course for the big boats outside. Tres



Gordo Sailing's Andrews 50 *It's OK* took top honors on the random leg track.

We were invited aboard Ed Feo's Andrews 45 *Locomotion* for the weekend and had a blast. The downwind-screamer was fresh off a class win and second overall in Encinal YC's Coastal Cup. With a skilled owner-driver, *Locomotion's* fun and seasoned crew took the solemn news about Farrah Fawcett and Michael Jackson in stride — wearing a single sailing

glove on Friday in the latter's honor.

"It's a great regatta," said Feo, who grew up and has lived most of his life within minutes of the venue. "The summer wind in Long Beach is robust, the competition is good across the classes and the parties make the event. In terms of our race, the random leg class gives us a chance to spend some quality time sailing downwind in breeze, interrupted by unfortunately long jib reaches — not our forté, but fun nonetheless. Kudos to *It's OK*, which has really stepped up its game this year."

David Voss's *Piranha* used a strong final day to overcome both a DSQ from Friday, and many years' worth of runner-up finishes, to finally take the Race Week Farr 40 crown after a duel with Ray Godwin's *Temptress*. Voss also garnered Boat of the Week honors for his efforts.

Gary Mozer and *Current Obsession2* pummeled the J/105 division — the event's largest at 13 boats — with five bullets in seven races. In PHRF 1&2, Mark Surber's J/125 *Derivative* and Viggo Torbensen's IMX38 *Martela* used bullets in their final races to close out wins in their respective divisions with the former pulling down PHRF Boat of the Week honors. Bruce Golison sailed his Etchells *Cahoots* to a handy win in

PHRF 3, counting five bullets.

Other one-design winners included Chuck Nichols' *CC Rider* in the 10-boat J/120 division and Garret Woodworth's *Frequent Flyer* in the six-boat Farr 30 division. The son-and-father duo of Payson and Phillip Infelise took the five-boat Flying Tiger division with *Mile High Klub*, and Dave & Don Michaelis' *Mako* bested six other Schock 35s. Thomas Brot's *Electra* won the five-boat J/109 divi-



# THE RACING

sion. The five-boat J/29 division went to Bruce Lotz' *Sedona*, while Gary Kamin's *Fired Up* beat seven other J/80s to take that class. Chris Snow's *Bogus* took the seven-boat J/24 Division, despite skipping the first two of seven races.

The Cal 25s turned out five boats with Steve and Jane Horst's *Jane's Addiction* — we've got to wonder if what 'Jane says,' goes — scoring five bullets and two seconds for the win. The division also produced the winner of the Kent/Golison Family Trophy for the boat sailing with the most family members — Art and Scott Melendres' *One Time* — which featured father Art, son Scott, daughter Monica Oveido and nephew Chris Lopez.

Chuck Clay's *Team ABYC* took the surprisingly small Catalina 37 Division. The 37s, maintained and owned by the Long Beach Sailing Foundation, are chartered out for regattas like these — in addition to being used for match racing events like the Mayor's, Ficker and Congressional Cups — and usually have a good deal more than the three boats represented at Race Week this year. One of those three was Bay Area Express 37 sailor Bill Riess (*Elan*), who's *Riess' Pieces* team finished second.

Race Week offers that quintessential Southern California sailing experience that might initially seem a bit foreign to sailors accustomed to the Bay: you can leave your foulies at home, but bring your kelp cutters and don't fear the oil rigs that sometimes function as marks. Time was, it was a pretty common event for Bay Area boats — drawn by both the tight race management, and the parties with free food and short lines.

Ullman Sails' Steve Beck, who spent the weekend aboard *Tempress*, was riding high at the poolside post-regatta festivities at Long Beach YC.

"Both ABYC and LBYC did a phenomenal job, as always, of producing an epic sailing event for all the fleets and participants," Beck said. "There are countless numbers of players behind the scenes who work exceptionally hard — literally too many to thank. But I'd be remiss in not mentioning the committee of Glenn Selvin, Bobby Frazier, Mark Townsend, Jim Bateman, Sandy Toscan, Ken Reiff, Jennifer Kurtiz, Dave Stotler, John Busch and Randy Beers. For Ullman Sails, it really is the perfect way to give back to our sport and our community. Race Week is one of the very few regattas that — win or lose — the sailors always say, 'I am so glad I was a part of it.'"

Race Week was also the finale for



ALL PHOTOS RICH ROBERTS UNLESS OTHERWISE NOTED



the the Ullman Sails Inshore Championship series, which also includes the Ahmanson Cup, San Diego Yachting Cup, and Cal Race Week. You can find full results from the series at: [www.ullmansailswestcoast.com/USIChome.htm](http://www.ullmansailswestcoast.com/USIChome.htm). The results from Race Week are at: [www.lbrw.org/index.html](http://www.lbrw.org/index.html).

— latitude/scg

## Trans Tahoe Race

Thirty-seven boats turned out for the 46th annual Trans Tahoe Regatta June

11. Divided into seven classes, the fleet started shortly after noon under warm, sunny skies and 10 knots of breeze on the 35-mile route from Tahoe City to Sugar Pine Point on the lake's west shore, over to Deadman's Point on the east shore, and back. Winds were forecast to rise two knots per hour and temperatures to remain steady. The Tahoe Yacht Club was all set for its summer classic, but the alpine weather caught more than few boats off-guard.

Wind speeds rose steadily to 18 knots





Clockwise from above — Eleven Open 5.70s showed up for their biggest stateside regatta yet; ridin' the rail aboard 'Locomotion'; Steve Brown's 'Wild Thing' leads Farr 30 division winner Garrett Woodworth's 'Frequent Flyer'; Richard Fish's Schock 35 'Outlier' adds some complexity to a simplified stability test; a Melges 24 in the firing line of a gaggle of J/105s; Drew Harper's 'Boom Slang' hotted-up and gunning for the Viper 640 competition.



LATTITUDE/SHAWN

throughout the first two legs. Then, shortly after the leaders rounded the leeward mark at Deadman's Point, dark clouds appeared over Desolation Wilderness. The air temperature suddenly dropped 20 degrees for the long beat to weather while the wind speed quickly doubled, gusting to over 40 knots. Then the rain arrived, going from sprinkles to a downpour to sleet. Visibility diminished radically, and the lake chop rose to three feet, coming from directly to windward.

Smaller boats still running downwind

were rounding up. Several spinnakers blew out and mainsails shredded, leaving a number of vessels incapacitated and in need of a Coast Guard rescue. Many sailors — prepared for mild temperatures and moderate breeze — found themselves wet and cold in their shorts and T-shirts. Fortunately, no one went overboard into the chilly lake water. The unexpected severe weather lasted for about two hours; by the time it had passed, most of the horses had already headed back to the barn.

Only six of the 33 starters in the racing division finished the course, while three of the four starters in the cruising division finished their shorter track.

The Bay Area's Ross Stein sailed his Corsair 24 *Origami* to the Corsair 24 division and overall wins, beating division and overall runner-up Pete Adams' *Gajjin* by just over two minutes.

Breaking with the Japanese boat names was the Division 1 winner — and third overall — *Wicked*, John Corda and Richard Courcier's Farr 36 ODR.



# THE RACING

Randy Chitwood's Catalina 30 *Charisma* won the four-boat cruising division that sailed a 24-mile course. The three-boat Melges 24s sailed an inshore buoy series, completing four of the six races scheduled.

Our J/124 *Pleiades* was the Division 1 runner-up after we reached the finish line around 5 p.m. in a near-calm, bright sunshine and warm air again. Welcome to Lake Tahoe!

— Jim & Jamie Casey

## 46th TRANS-TAHOE REGATTA (7/11)

OVERALL — 1) **Origami**, Corsair 24, Ross Stein; 2) **Gaijin**, Corsair 24, Pete Adams; 3) **Wicked**, Farr 36 ODR, John Corda/Richard Courcier; 4) **Pleiades**, J/124, Jim & Jamie Casey; 5) **Sustantivo**, Beneteau 10R, Stephen Crozier; 6) **Poopsie**, SC 27, Jason Roach. (33 boats)

CORSAIR 24 — 1) **Origami**; 2) **Gaijin**. (5 boats)

DIVISION 1 (PHRF ≤ 96) — 1) **Wicked**; 2) **Pleiades**; 3) **Sustantivo**. (8 boats)

DIVISION 2 (PHRF 99-150) — 1) **Poopsie**. (7 boats)

DIVISION 3 (PHRF ≥ 153) — No finishers. (5 boats)

CRUISING CLASS — 1) **Charisma**, Catalina 30, Randy Chitwood; 2) **Sorceress**, Hunter 35.5,

James Walsh; 3) **Brainwave**, Wylie 30, Charles Quagliari. (4 boats)

MELGES 24 (6r/0t) — 1) **Personal Puff**, Dan Hauserman, 15 points; 2) **Mako**, Steven McMillan, 19; 3) **Zoom Zoom**, Pete Russell, 21. (3 boats)

Complete results at: [www.tahoeyc.com](http://www.tahoeyc.com)

## Lipton Cup

The PICYA's Daphne Owen checked in with a report from a reworked Lipton Cup:

"We had fourteen boats total — two J/105s sailing for the Sir Thomas J. Lipton Perpetual Trophy, four Islander 36s sailing for the Larry Knight Perpetual, three Express 27s sailing for the Sir Thomas Lipton Challenge, and five Olson 25s sailing for the Admiral's Cup — which was better than expected," Owen said. "Changing the format was a contributing factor, plus fewer scheduling conflicts.

"Talking to the racers at the after-race party, we had positive feedback with regard to the changes in format. Everyone agreed the change to one design from PHRF was very good, although there are



PETER LYONS/WWW.LYONSIMAGING.COM

some naysayers — not racers — from clubs who would like to see things stay the way they were. They need to let go and move on!

"There were three races total — two Saturday and one Sunday. This may

## THE BOX SCORES

CORSAIR — 1) **Flash**, Brett Nelson. (1 boat)  
Complete results: [www.beniclayachtclub.com](http://www.beniclayachtclub.com)

### CORINTHIAN YC FRIDAY NIGHT SERIES (7/17)

J/105 — 1) **YIKES!**, Sue Hoeschler; 2) **Vim**, Garry Gast; 3) **Danae**, Steven Block. (3 boats)

SPINNAKER 3 — 1) **Big Wow**, Rhodes 19, Tom Royal; 2) **Can O' Whoopass**, Cal 20, Richard vonEhrenkrook; 3) **Wuda Shuda**, Soverel 26 OB, Craig Page. (7 boats)

NON-SPINNAKER 3 — 1) **Sizzler**, Northstar 727, Peter Yolles; 2) **Chica**, Cal 20, Ted Goldbeck; 3) **Tension II**, Cal 20, John Nooteboom. (4 boats)

NON-SPINNAKER 1 — 1) **Q**, Schumacher 40, Glenn Isaacson; 2) **QE3**, Tartan 10, Tom Perot; 3) **Elusive**, Olson 911S, Charles Pick. (8 boats)

SPINNAKER 2 — 1) **Yucca**, 8 Meter, Hank Eason; 2) **Good n' Plenty**, Soverel 33, Will Baylis; 3) **Abigail Morgan**, Express 27, Ron Kell. (10 boats)

NON-SPINNAKER 2 — 1) **Summer Sailstice**, Ranger 33, John Arndt; 2) **Belle Amie**, Hunter 356, Dale Weibel; 2) **Maxine**, Yankee 30, Stephen Spoja. (7 boats)

Complete results: [www.cyc.org](http://www.cyc.org)

### GOLDEN GATE YC FRIDAY NIGHT SERIES (7/17)

1) **Snafu**, Canadian Sail, Maurice Quillen; 2) **Rambler**, Cal 20, Mike Farrell; 3) **Banana**, Cal 2-29, Wayne Carley. (7 boats)

Complete results: [www.ggyc.org](http://www.ggyc.org)

### IYC SUMMER TWILIGHT SERIES

DIVISION A (PHRF 0-150) — 1) **Audacious**,

J/29, Scott Christensen; 2) **Spirit of Freedom**, J/124, Bill Mohr; 3) **Mon Desir**, Jeanneau 35, Jerry Nasso; 3) **Fun Zone**, Santana 22, Tom McIntyre. (4 boats)

168 RATERS — 1) **Bewitched**, Merit 25, Laraine Salmon; 2) **Phantom**, J/24, John Guilford; 3) **My Tahoe Too!**, Capri 25, Steve Douglass. (5 boats)

DIVISION D (PHRF > 150) — 1) 1) **Lelo Too**, Tartan 10, Emiles Carles; 2) **Dumbo**, Catalina 22, David Torris; 3) **Fun Zone**, Santana 22, Tom McIntyre. (8 boats)

NON-SPINNAKER — 1) **Svenska**, Peterson 34, Fred Minging; 2) **Cool Change**, Freedom 32, Aaron Stagg. (3 boats)

Complete results: [www.iyc.org](http://www.iyc.org)

### MPYC SUNSET SERIES (7/15)

PHRF A — 1) **Bustin' Loose**, Pulford; 2) **Sea Saw**, Cordrey; 3) **Mas Rapido**, Chaffey. (4 boats)

PHRF B — 1) **Joss**, Duncan; 2) **Fleeboflam**, Chaffin; 3) **Mizzen**, Baxter. (8 boats)

SHIELDS — 1) **Harriet**, Stratton; 2) **October**, Jackson; 3) **Medora**, Feely. (4 boats)

Complete results: [www.mpyc.org](http://www.mpyc.org)

### SAUSALITO YC SUNSET SERIES

(On scheduled hiatus as of press time, resumed 7/28)

Complete results at: [www.syconline.org](http://www.syconline.org)

### SOUTH BEACH YC FRIDAY NIGHT SERIES (7/17)

CLASS D (Spin <114) — 1) **Savage Beauty**,

We would like to keep a running tab on beer can results through the summer — and we need your help. We don't have the time or manpower to chase down results. You have to either post them on a website or send them directly to the race editor at [rob@latitude38.com](mailto:rob@latitude38.com). Our format, for these many years, is to include the name of the boat, the type and length of boat, and the first and last names of the owner(s). The following are the only results that were posted online for July. Don't forget the *Latitude 38* Beer Can Challenge: sail every night at a different beer can race in any given week, then send us photo documentation, and we'll send you some swag to commemorate your pursuit of sailing satisfaction. Happy Summer!

### BEER CAN SERIES

#### BVBC MONDAY NIGHT MADNESS (7/20)

(nothing posted for July)

#### BENICIA YC THURSDAY NIGHTS (7/9)

A FLEET — 1) **Enigma**, Randall Lesley; 2) **Bluefin**, Noble Griswold. (2 boats)

B FLEET — 1) **Stolen Moments**, Deborah Lyons; 2) **Too Tuff**, Tom Hughes; 3) **Kelika**, Mike Weaver. (4 boats)

C FLEET — 1) **Yippee!**, John and Johanna Wright; 2) **Alte Liebe**, Jerry Martin; 3) **Katie Bay-B**, Mike Munn. (4 boats)



Five Olson 25s sailed for the PICYA's Admiral's Cup trophy.

also change for 2010, as the majority of racers believe having three on one day would be more enjoyable."

Tim Russell's *J/105 Aquavit* took home the 'Big Lipton,' the Sir Thomas

J. Lipton Perpetual for San Francisco YC. Tom Newton's *Islander 36 Captain Hooke* took home the Larry Knight Perpetual to Richmond Y.C. Tom Hintz' *Express 27 Opa!* won the 'little Lipton' — the Sir Thomas Lipton — trophy for St. Francis YC and Steve Smith's *Olson 25 Synchronicity* left for Half Moon Bay YC with the Admiral's Cup.

#### Classic Plastic Never Gets Soft

The Bay View Boat Club's Plastic Classic Regatta is unique for a couple reasons. First

it's the only regatta we know of to have been first kicked-off by an iconic stripper — Carol Doda — way back when. Second it's the only regatta we know of that takes its legacy so seriously that

Elan 40, Gerard Sheridan; 2) **007**, *J/105*, Bruce Blackie; 3) **Jolly Mon**, *J/120*, Chris Chamberlin. (6 boats)

CLASS E (Spin >115) — 1) **Highlighter**, *Islander 36*, Bill Hackel; 2) **Independence**, *J/32*, Joe Wells; 3) **Moondoggie**, *Islander 36*, BGS Partners. (7 boats)

CLASS F (Non-spin <130) — 1) **Josie**, Dehler 39, Don Sellers; 2) **Savoir Faire**, Beneteau First, Paul Osborn; 3) **Seaview**, C&C 115, Pete Hamm. (7 boats)

CLASS G (Non-spin > 131 except Catalina 30) — 1) **Synergizer**, Ericson 28, Larry Weinhoff; 2) **Double Play**, Yankee 30, RDK Partners; 3) **Star Ranger**, Ranger 26, Simon James. (8 boats)

CLASS J (CATALINA 30) — 1) **Friday's Eagle**, Mark Hecht; 2) **Dancing Bear**, Loe Askins/Ray Hall; 3) **Adventure**, Jack McDermott. (10 boats)

#### ST. FRANCIS YC:

##### CABRINHA THURSDAY NIGHT KITEBOARDING SERIES (7/9, 3r/0t)

OVERALL — 1) Sean Farley, 5 points; 2) Bruno Sroka, 6; 3) Paolo Rista, 13; 4) Chip Wasson, 14; 5) Stefaans Viljoen, 14. (43 kites)

MASTER — 1) Chip Wasson, 14 points; 2) Adam Vance, 23; 3) Donny Parker, 50; 4) Eric Geyleynse, 63; 5) Jim Keenan, 79. (12 kites)

GRAND MASTER — 1) Bob Smith, 58 points; 2) Bret Herscher, 81; 3) Raymond Deiter, 159. (5 kites)

##### FRIDAY NIGHT WINDSURFING SERIES (7/10, 5r/1t)

FORMULA BOARDS — 1) David Wells, 5 points; 2) Eric Christianson, 8; 3) Steve Bodner, 10; 4) Al Mirel, 15; 5) Chris Radkowski, 17. (14

boards)

##### WEDNESDAY EVENING SERIES (WOODIES)

(On scheduled hiatus as of press time, resumed 7/28)

Complete results at: [www.stfyc.org](http://www.stfyc.org)

##### SVENDSEN'S THURSDAY NIGHT SERIES TREASURE ISLAND SC (7/16, 5r/0t)

VANGUARD 15 — 1) Jim Barkow/Melanie Roberts, 9 points; 2) Andrew Watters/Elsie 'Andrew should've included his crew's last name', 17; 3) Tom Allison/Greg Stemler, 17; 4) Ken Turnbull/Abby Swan, 24; 5) Kevin Richards/Elizabeth Jackson, 35. (19 boats)

Complete results at: [www.vanguard15.org](http://www.vanguard15.org)

LASER — 1) Mark Halman, 6 points; 2) Mike Bishop, 9; 3) Ryan Nelson, 18; 4) Kurt Wessel, 29; 5) Niko, 31. (10 boats)

Complete results at: [www.tilaserfleet.org](http://www.tilaserfleet.org)

##### VALLEJO YC WEDNESDAY NIGHTS (7/14)

A FLEET — 1) **X-TA-C**, Olson 29, Sweitzer; 2) **Tutto Bene**, Beneteau 38S5, Vetter; 3) **De'gagè**, Ranger 23, Ruzsler. (7 boats)

B FLEET — 1) **Splash**, Beneteau, Mullinax; 2) **Lita-K**, Catalina 42, Karuzas; 3) **Sleepy Head**, Triton, Kuykendall. (6 boats)

Complete results: [www.vyc.org](http://www.vyc.org)

#### WEEKEND EVENTS

##### SFYC EASOM FOUNDERS & MELGES 24 REGATTA (7/11-12, 5r/0t)

ETCHELLS — 1) **Mahalaga**, Peter Vessella, 13 points; 2) **JR**, Bill Melbostad/Bryan Moore, 17; 3)

one of the finish marks — this year Arjun Bok's *Lidgard 43 RotKat* — maintains a living, bouncing and topless homage to its dedicator.

Originally intended for fiberglass boats built before 1970, this year's regatta, on July 18, was the first to include a new division for fiberglass boats built more than 20 years ago. The two categories sailed in separate divisions, and wouldn't you know it, both were represented in the top-three!

##### PLASTIC CLASSIC (7/18)

OVERALL — 1) **Phantom**, *J/24*, John Guilford; 2) **Lazy Lightning**, Tarten 10, Tim McDonald; 3) **Windsong**, International Folkboat, Paul Harris; 4) **Meliki**, Santana 22, Tom Montoya; 5) **Free Variable**, Cal 29, Ellen She; 6) **Serendipity**, Cal 29, Philip Hyndman; 7) **Bolero**, Triton, Ely Gilliam; 8) **Adventure**, Catalina 30, Jack McDermott; 9) **Windwalker**, *Islander 36*, Richard Shoenhair; 10) **Portugal Princess**, Pearson, Michael Bell. (46 boats)

PHRF 1 (PHRF 200-251) — 1) **Windsong**; 2) **Meliki**; 3) **Cajun**, Cal 2-25, William Thamm. (13 boats)

PHRF 2 (180-199) — 1) **Free Variable**; 2) **Serendipity**; 3) **Adventure**. (9 boats)

PHRF 3 (150-179) — 1) **Phantom**; 2) **Brigadoon**, Blackwatch 37, Robert Horton; 3) **Blue Ex-**

**Dinner Roll**, Jeff Moseley, 19. (13 boats)

MELGES 24 — 1) **Practice Girl**, Christopher Farkas, 11 points; 2) **BONES**, Robert Harf, 14. (2 boats)

Complete results at: [www.sfyc.org](http://www.sfyc.org)

##### ST. FRANCIS YC ALBERT T. SIMPSON REGATTA (7/18-19, 5r/0t)

ETCHELLS — 1) **JR**, Bill Melbostad/Bryan Moore, 9 points; 2) **Mr. Natural**, Ben Wells, 10; 3) **GINNA FE**, Michael Laport, 15. (7 boats)

J/24 — 1) **On Belay**, Don Taylor, 8 points; 2) **Little Wing**, Luther Strayer, 9; 3) **Downtown Up-roar**, Darren Cumming, 18. (5 boats)

J/105 — 1) **Donkey Jack**, Rolf Kaiser, 26 points; 2) **Arbitrage**, Bruce Stone, 26; 3) **Blackhawk**, Scooter Simmons, 35. (23 boats)

Complete Results at: [www.stfyc.org](http://www.stfyc.org)

##### SBYRA #4 (SLYC, 7/11)

DIVISION A — 2 starters, no finishers.

DIVISION B — 1) **Sparky**, Catalina 25, Paul Zell; 2) **Mike Haddock**, C&C 110, Mike Haddock. (2 boats)

##### IYC SILVER EAGLE (7/11)

SILVER EAGLE (PHRF<sub>≤</sub>101, 47.7 miles) — 1) **Centomiglia**, FT 10, Fabio Maino; 2) **Papillon**, F-27, Andrew Scott; 3) **Peregrine Falcon**, F-27, Bill Gardner; 4) **Macondo**, Beneteau First 47.7, Camilo Martinez; 5) **Savoir Faire**, Beneteau First 42, Paul Osborn. (15 boats)

SILVER EAGLE (PHRF<sub>≥</sub>102 30.6 miles) — 1) **Phantom**, *J/24*, John Guilford; 2) **Cassiopeia**, *Islander 36*, Kit Wiegman; 3) **Dumbo**, Catalina 22, David Torrisi. (3 boats)

Complete results at: [www.iyc.org](http://www.iyc.org)



# THE RACING

press, Pearson 32, Corey Wurzner. (3 boats)

PHRF 4 (100-149) — 1) **Lazy Lightning**; 2) **Windwalker**; 3) **Pilot**, Islander 36, Paul Zingaro. (9 boats)

PHRF 5 (<99) — 1) **Par Avion**, Carrera 38, Franz Steiner. (1 boat)

ISLANDER BAHAMAS (various boats between PHRF 255 and 267) — 1) **Portugal Princess**; 2) **Can O' Whoopass**, Cal 20, Richard vonEhrenrook; 3) **Constellation**, Islander, John Lincoln. (7 boats)

TRITON — 1) **Bolero**; 2) **Sanctuary**, Ian Elliot; 3) **Juno**, Steve Cossman. (4 boats)

Complete results: [www.plasticclassic.com](http://www.plasticclassic.com)

## Boreas Race

The 61st annual Boreas Race — jointly sponsored by Elkhorn YC and Half Moon Bay YC — on July 4th was characterized by light air from the south, switching to southwest later in the day, and uncommonly flat water.

The usual exhilarating downwind run from Pillar Point to Moss Landing became a short tacking in-shore experience that tested the gumption of the crews.

Two Santa Cruz boats drew away from the fleet early. *Stretch*, Mark Schipper's Hobie 33, posted a more

than respectable first to finish and first overall elapsed time of 10 hours 26 minutes for the 57-mile course, with John Blackburn's SC 40 *Camelot* finishing just 34 minutes later to take second place. John Goetsch's Ericsson 38, *Windhold* was third.

Boats from Elkhorn Yacht Club, Half Moon Bay, Santa Cruz and Monterey Peninsula clubs made up the 10-boat fleet. Honors for perseverance go to Elkhorn YC's Rich Richards, whose Catalina 38 *Touché* was the only surviving boat in the cruising division — arriving at 4 a.m. on July 5th after 18 hours on the race course.

## El Toro Junior North American Championships

Forty junior El Toro sailors showed up for this year's Junior North American Championships in Stockton July 17. The 17-boat Gold and 23-boat Silver fleets grew this year as a result of the championship's being tacked on

to the week-long Stockton Sailing Club/Santa Cruz YC/Richmond YC Sail Camp.

In 100-degree heat and breeze of five to ten knots, the two fleets were forced to stick close to the east bank of the river due to a strong flood. Los Altos' Michael Pacholski made the most of the conditions, scoring a 1-1-3 to emerge as the new Junior North American Champion.

Pacholski finished two points clear of runner-up Wilson Fletcher and three-points clear of third-place Haydon Stapleton. Michael Marlett scored a 1-2-2 to take the silver fleet crown beating out Ellen Hann, winner of the last two races, and Jessica Dougherty.



Reflective coating minimizes UV & heat

Unique 'Air Arch' maximizes cockpit space

**RONSTAN**

## Inflatable Boom Tents

- Shower proof
- Light and compact
- Easily mounted
- Highly adjustable

**NEW PRODUCT — BIG SAVINGS!**

Boom Tent for 25-30 ft. boats.....List \$549.00	<b>YOUR PRICE: 494.10</b>
Boom Tent for 30-35 ft. boats.....List \$599.00	<b>YOUR PRICE: 539.10</b>
Boom Tent for 35-40 ft. boats.....List \$698.00	<b>YOUR PRICE: 628.20</b>
Boom Tent for 45-45 ft. boats.....List \$799.00	<b>YOUR PRICE: 719.10</b>

While supplies last.

**SVENDSEN'S MARINE** 510.521.8454  
svendsens.com

1851 Clement Ave., in the Alameda Marina • Open 7 Days/Week



## OYSTER POINT Marina/Park



*A full service marina located in South San Francisco with berthing and guest dockage available*

For information and pricing call

**(650) 952-0808**

[www.smharbor.com/oysterpoint](http://www.smharbor.com/oysterpoint)



PETER LYONS/WWW.LYONSMAGING.COM

**The Bay View Boat Club's Plastic Classic Regatta brought out plenty of resin and glass July 18.**

Christina Gasparich finished fifth overall in the Gold fleet to take the perpetual trophy for the top girl at the North Americans. Sarah Lake and Emma Drejes weren't far behind in seventh and eighth place respectively. In the Silver fleet, Hann and Dougherty were followed closely by Fiona Fowler in fifth.

Complete results and more pictures are posted at: [www.eltoroyra.org](http://www.eltoroyra.org).

**Race Notes**

Looking ahead — as busy as July was, August is going to be an even bigger

month for big events on the Bay. Between the August 16-30 **505 North Americans and Worlds** at St. Francis YC — which will also play host to the **Kiteboarding Worlds** from the 4th through the 8th and the **Aldo Alessio Regatta** July 31-August 2 — the **American Sailing League** at Pier 39 on the 29th and 30th, the **J/24 and Olson 25 Nationals** at Berkeley YC, and numerous other lower-profile, but nonetheless valuable events, it's going to be one doozy of a month.

But there's one event you shouldn't miss . . .

Sarcoma survivor Nathalie Criou started the **Sarcoma Cup** in 2008 as a way to raise money for research on treating the group of more than 50 cancers of the connective tissues that are extremely rare. They represent only one percent of the adult cancer cases and 15-20 percent of children's cases. They're resistant to most common treatments, are only detectable with a biopsy and usually require surgery for therapy.

The illness' rarity, coupled with the fact they receive little funding — less

## HIRSCHFELD YACHT LLC

Offering the *best value* in the Bay Area for:  
Marine Repair, Service, and Repowers

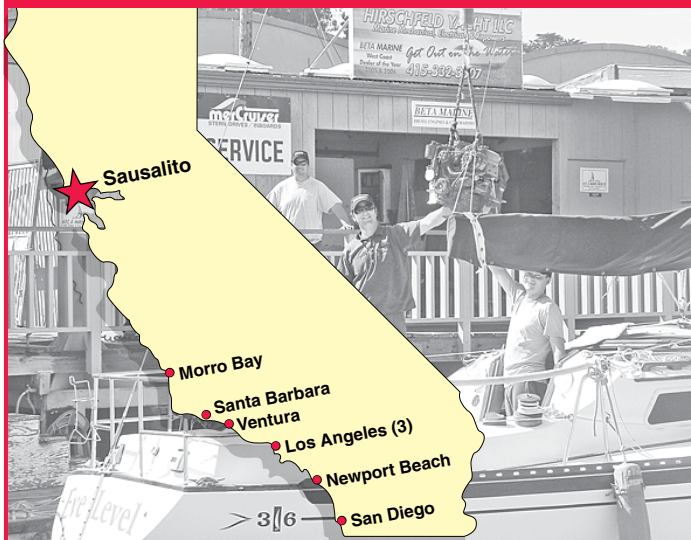

We are the exclusive distributor of  
Beta Marine diesel engines and generators in California.

### BETA MARINE WEST

39 Libertyship Way, Sausalito, CA 94965  
[www.engineerite.com](http://www.engineerite.com) • [www.betamarinewest.com](http://www.betamarinewest.com)  
**(415) 332-3507**



HEADED TO BAJA?

## Empieza Aquí.

Racing to Cabo or cruising to Cortez, Landfall is the place to start for world-class Steiner binoculars, radios, cruising guides, expert advice and more. Call or click for a free catalog or to sign up for our monthly Landfall Report e-mail. Shop online anytime.



**800-941-2219** | [landfallnav.com](http://landfallnav.com)

**SAFETY | NAVIGATION | REFERENCE | WEAR**

©2009 Landfall Navigation. All rights reserved.



# THE RACING

than one percent of all available cancer research funds — mean that an event like the Sarcoma Cup, **August 22-23**, can go a long way toward raising both funds and awareness of the diseases. One hundred percent of the money raised will go toward funding Sarcoma research.

Last year the event raised over \$18,000 in its first edition. This year, Criou hopes to at least double that. If the growing list of entries is any indication, it may be attracting enough critical mass to get there.

Hosted by Richmond YC, the regatta will feature one-design, cruising and PHRF divisions sailing in the club's tried-and-true format of a day of buoy racing followed by a pursuit race on the second day. The J/105s have the option of doing two days of buoy racing.

The winner of the regatta will receive a free haul-out — as if you needed any more motivation to go sailboat racing for a really good cause. There's a full-on raffle with prizes like a Garmin GPS, Sony car stereo, Logitech webcam and first-class subscription to *Latitude 38*.



*Haydon Stapleton threads the needle at the El Toro Junior North American Championships.*

There'll be a free wine bar to accompany the live rock n' roll band and free massage. Afterwords you can hit up the

Silent Auction.

Check out: [www.beatsarcoma.org/Sarcoma\\_Cup.html](http://www.beatsarcoma.org/Sarcoma_Cup.html), and [www.richmondyc.org](http://www.richmondyc.org) for more info on the disease, the regatta, online registration and more.

## Wright Way designs

Custom Yacht Interiors

---

**PROFESSIONAL DESIGN SERVICES INCLUDE CUSTOM**

- carpeting
- cushions
- designer fabrics
- draperies
- linens
- upholstery



**Deborah Wright**  
510.908.3939

2900 Main Street #67, Alameda, CA 94501  
[wrightwaydesigns@hotmail.com](mailto:wrightwaydesigns@hotmail.com)  
 Check out our new web site:  
[www.wrightwaydesigns.com](http://www.wrightwaydesigns.com)



## RICHARDSON BAY MARINA

formerly Kappas Marina

---

MODERN FACILITIES IN A WELL-PROTECTED HARBOR

---

**Concrete Dock System**

**Well Maintained Facilities**

**Beautiful Surroundings**

- DEEP WATER BERTHS: BASIN AND CHANNEL DREDGED
- CARD KEY SECURITY SYSTEM
- DOCK CARTS
- PUMP OUT STATION
- AMPLE PARKING
- CLEAN SHOWER AND TOILET FACILITIES
- WITHIN WALKING DISTANCE: MARKET/DELI, LAUNDROMAT, RESTAURANT
- AT EACH BERTH: LARGE STORAGE BOX, METERED ELECTRICITY, PHONE HOOKUPS, WATER

---

BERTH YOUR BOAT IN SAUSALITO

---

415 332-5510 [www.richardsonbaymarina.com](http://www.richardsonbaymarina.com)  
 100 Gate Six Road, Sausalito • Fax 415 332-5812

# STAY FOCUSED WITH OUR EYE SAFE NO-STING FORMULA



Z Blok sunscreen's new non-greasy formula will not burn or irritate your eyes. So you can concentrate on winning the race or just enjoying a great day on the water. Z Blok is also fragrance free.

Z Blok is the official sunscreen of the PUMA Ocean Racing Team. Skipper Kenny Read said:

**"The UV protection is excellent. Every member of the team is a true believer. We have put Z Blok to a tough test that few others can. Most importantly, we have experienced no eye stinging or irritation and we use it every day."**

Visit [zbloksun.com](http://zbloksun.com)  
or call 508.995.9511

**OFFICIAL SUNBLOCK OF THE  
PUMA OCEAN RACING TEAM**

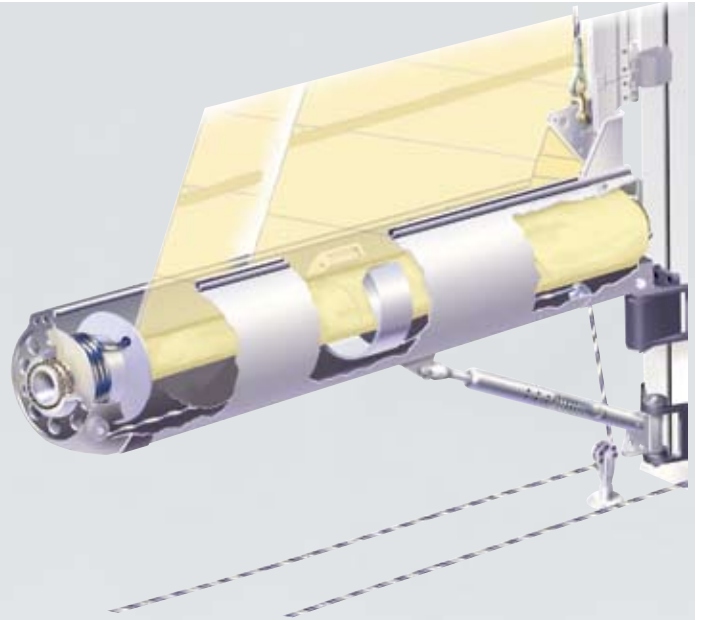

## FURL ON THE FLY.

With Schaefer's innovative boom furling system and patented articulating sail track, you can reef your main on any point of sail - all from the safety of the cockpit. Trouble free reefing and furling - just what you would expect from Schaefer Marine.

**SCHAEFER**  
LEGENDARY STRENGTH

508.995.9511  
SCHAEFERMARINE.COM

## GLEN COVE MARINA

**WE ARE  
DREDGING**



**DREDGING  
THE ENTIRE MARINA**

**(707) 552-3236**

2000 Glen Cove Road, Vallejo, CA 94591

[www.glencovemarina.net](http://www.glencovemarina.net) • [glencovemarina@gmail.com](mailto:glencovemarina@gmail.com)

*"The elegantly simple, single-sail Wyliecat 30 makes the fun of sailing instantly accessible."*

*Sailing Magazine*

*Experience the high performance and simplicity of the Wyliecat design.*

**WYLIECAT 30**  
*Sailing In The Right Direction*

Models: 17 | 30 | 39 | 48 | 65 | 66

[www.wyliecat.com](http://www.wyliecat.com) • Tel: 916-743-7194



# WORLD

*We depart from our usual format this month, to bring you a special report on what is arguably the most action-packed charter flotilla anywhere, the British Virgin Islands' **Highland Springs HIHO**.*

## **Fit Sailors, Fast Action & Comfy Cats: An Ideal Recipe for Summer Fun**

In the realm of sailing, long-established special events often reach a peak, then fizzle and die. There are a rare few, however, that keep evolving, and by doing so just get better and better. A case in point is the annual Highland Springs HIHO, which celebrated its 25th anniversary early last month in the British Virgin Islands — and was a huge success.

Back in the late '70s, windsurfing was the sexiest watersport around. With the promise of high speeds and heart-pounding thrills, the sport's flashy, multi-colored sails and planing boards steadily attracted new devotees all over the world. It was against that backdrop that the original HIHO was spawned with a unique concept: It was to be an ambitious, week-long event that would test the endurance of riders through a series of long-distance, inter-island races over open water — hence the event's original full name: Hook In and Hold On. When not out on the water, participants would be accommodated aboard charter boats that would lace through the island chain from one must-see anchorage to the next.

As word of this fun-filled enduro spread, it attracted top-flight competitors from Europe, the U.S. and beyond. Like-

***The contemporary HIHO's successful formula revolves around island-hopping to a different must-see anchorage every day.***

wise, the promise of participants who were young, athletic, and hard-bodied attracted the event's founding sponsor, Johnnie Walker.

While the sponsorship money was essential for the event's operation, whiskey and windsurfing seemed an odd pairing. We remember observing back then that probably the last thing a dehydrated athlete wanted after completing a 15-mile sprint was a 'Johnnie Colada' — yeah, they were pretty awful. So after the 1986 contest, Walker & Co. packed up its Colada mix and pulled the plug.

That year, a young BV Islander named Andy Morrell tied for top honors, which launched him into a short career as a World Cup contender. But in spite of tasting international notoriety, he always felt the HIHO concept was too good to let die, so in 1992 he bought the name and resurrected the event. Since then, it has been in a constant state of evolution, adapting to include the newest gear on the market, the newest charter boat options and the shifting demographics of the sport. Having been widely publicized in both print and visual media, the HIHO has long been considered the Holy Grail of windsurfing. Or as one elder competitor put it, "It's on every longtime rider's bucket list."

This year's event drew about 140 participants from 14 countries, of whom 50 were racers. The rest were along for the ride, so to speak, enjoying the daily race action, lavish shoreside meals and



ALL PHOTOS LATITUDE / ANDY

nightly parties. The entire entourage was accommodated aboard late-model, four-cabin charter cats from The Moorings.

This writer was one of five 'California captains' who came out to play skipper while soaking up some summer sun. I was lucky enough to draw a nearly-new Moorings 4600 — the design features a flybridge steering station that pokes through the hardtop bimini — and a very jolly crew. In addition to First Mate Julie, there were the Aussies, Nelle and Monty, and four sailing buddies from Virginia: Al, Susan, Wayne and Doctor Bob. All but Nelle were accomplished recreational sailors who were eager to race.

One of the coolest things about the HIHO, both way back when and today, is that you always come away having made new friendships with your crewmembers and others. Because active windsurfers are generally fit and fun-loving, and because the cruise is sold as a hands-on sailing adventure with fast-paced daily itineraries, it rarely, if ever, attracts whiners or stuffed shirts looking for white-glove service. My crew was typical of the rest of the fleet: 'doers' who were ready to gear up and go sailing as soon as the coffee was brewed, and equally ready to party when the sun began its slide toward the horizon.

Within the international mix of par-







**"We be Jammin'!" Dr. Bob Rowland and Wayne Hooper are windsurfing buddies on the Outer Banks. Doing the HIHO together had been a longtime dream.**

ticipants, the HIHO typically attracts top windsurfers from up and down the Eastern Caribbean's chain of islands. This year was no exception, with teams sailing up-island from Martinique, St. Martin and Antigua. Several USVI and BVI sailors also competed. It's always fun to hang with these folks, who live the sort of active, outdoor lifestyle day in and day out, that most of us only dream of.

There were plenty of Europeans in the mix this year too, the most notable of which were the Kornums, a handsome Danish family of four who, curiously, *arrived* at the event perfectly tanned from head to toe. Believe it or not, the British Royal Navy sent a team of racers for the third time! "It's amazing that you guys could all get the time off," we noted. "Time off? We're on duty here!" Gotta love the British. There was also an entire non-racing family from Taiwan who booked onto the trip just because it sounded like a whole lot of fun.

Day one of the HIHO is always a bit of a scramble. While captains scurried around The Moorings' staging area loading up the free cases of Highland Springs water and Red Stripe beer provided by

sponsors, participants trickled in from the airport dazed by jet-lag and anxious about the week ahead. But once the docklines were tossed off, the fleet set sail for Virgin Gorda's North Sound, and the residual stress from taxis, airports and overnight flights melted away.

As is often the case during the summer months, a tropical wave had descended over the territory, yielding hazy skies and light winds. The forecast, however, was for skies to clear soon, and winds to build throughout the week.

By the time the fleet assembled for a bountiful buffet dinner at Saba Rock that first night, spirits were already at a high rev. Rum, reggae and the warm caress of the trade winds fueled dancing until the wee hours.

Unlike some less-structured flotillas, where boats simply meander from one day's anchorage to the next, the HIHO schedule is intentionally set up to be action-packed. During the next six days, there would typically be a morning race, followed by a healthy lunch set up on some secluded sandy beach, then a sailboat cruise to that night's anchorage, followed by dinner — and often dancing — ashore at a waterside resort.

No one ever goes hungry, or has time to get bored.

We should clarify that the contemporary HIHO has two divisions: Open and One Design. Open Division racers ride ultra-fast, quick-planing 'formula' boards, while the One Design fleet — 85% of HIHO entries — ride more

**"What's not to like about it?" asks first-timer Rick Whiting of Sausalito. He and Nancy Friedman ran a 51-ft sloop that housed event staff.**





# WORLD

traditional Techno boards. All racers are allowed a quiver of up to three sails to choose from, depending on wind conditions.

The breeze was too fluky to race on day two, leaving everyone free time to snorkel, chill out, test-sail their rigs or peruse North Sound boutiques. But by day three wind conditions were ideal for the one-tack, 12-mile blast to remote Anegada Island.

An anomaly among her mountainous sister isles, Anegada is a low-lying coral-formed crescent that's hard to see from the water until you're within spittin' distance of it. On a full plane in 14 to 16 knots of wind, the top riders covered the distance in under 40 minutes. But for some, the open-water crossing was truly a rite of passage. Our Aussie crewman,

Monty, was so tired after his 2.5-hour ordeal that he couldn't raise his arms to wave hello when we saw him on the beach afterwards. St. Martin's Ricardy Maricel — who was strong enough to hold down a massive 11.8-square-meter sail in the 20-knot gusts — took line honors. A barbecued lobster dinner followed by dancing to a local band kept spirits high that night.

In the morning, the windsurfers got a taste of yacht racing as the fleet raced 16 miles back to Virgin Gorda's idyllic Valley Trunk Bay, adjacent to the famous Baths. We managed to completely bungle our start, but fought our way back past

all but four boats to save face. NorCal skipper Bill Price of Fairfax took line honors aboard a Moorings 4700 cat.

Later, the windsurfers followed a 14-mile reaching course to Trellis Bay in 14 to 18 knots, while non-racers explored the boulder-strewn grottoes of The Baths and nearby Fallen Jerusalem island.

That night's dinner and party capitalized on the Virgin Islands' most notorious historical characters: the pirates that plied these waters during the late 1700s and early 1800s. Virtually everyone — including British Naval officers — partied and danced in costume to a rockin' live band at Trellis Bay's Last Resort restaurant.

***Clockwise from upper left: Racers study the day's course; lunch on the beach; Sebastian the wonder kid; taking a break at The Baths; racers sprint for the finish line flagpole; our champ, Susan, completes race six; racers take off like a rifle shot toward Trellis Bay. All photos Latitude/Andy***





# OF CHARTERING

rant.

The next morning's 18-mile "down-wind monster" was brutal for some, partially due to a wind shift that came in after the marks were set. A tough up-wind leg preceded long zig-zags across the Sir Francis Drake Channel in 16 to 20 knots of breeze that proved to be a navigational nightmare for some first-timers. Exhausted, a number of racers elected to be picked up by the cats that patrolled this, and every, course. But one of the slower, yet more tenacious, Royal Navy guys refused to give up, eventually finishing after *five hours* of slogging. As he and others learned, one of the keys to success — or should we say, survival — on these long-distance enduros is picking the appropriate sail

for the prevailing conditions.

The island-hopping lunch caterers laid out the mid-day feast on yet another picture-perfect beach, this time at Peter Island's Deadman's Bay. While en route to that night's anchorage at Cooper Island, some HIHOers stopped to snorkel on the famous wreck of the *Rhone*, where the Peter Benchley thriller *The Deep* was filmed. Others snorkeled the shallows off Cooper's Cistern Point. The excellent Indian buffet that night at the Cooper Island Beach Club was a savory treat.

When light winds forced a delay in the next morning's race, which was to be a long-haul downwinder, we found another worthwhile snorkel spot tucked in behind Peter Island's Great Harbour point.

The fleet reassembled at tiny Thatch Cay — once owned by actor Alan Alda — which lies just west of Tortola's West End village and the notorious pirate hideaway called Soper's Hole.

Sailors are normally forbidden from coming ashore at the private mini-resort on Thatch, but it's long been a HIHO tradition to have lunch on its shady beach. What's unique here is that everyone gets to assemble his/her own personal pizza, then bake it in an authentic, outdoor brick oven modeled after those used during the plantation era.

By the time we'd digested that memorable meal, the breeze had piped up to around 18 knots, and a relatively easy around-the-island race was staged, with the Open Division boards rounding twice.





# WORLD OF CHARTERING

Nights ashore at nearby Jost Van Dyke are pretty much guaranteed to be fun, especially at Foxy's, where the fleet has gathered for years. Unfortunately for us, the place's namesake character, Foxy Callwood, was away in England receiving his MBE — a lofty honor awarded to very special British subjects. We managed to eat and party well without him, however. The pulse of the house band could be heard well out in the anchorage.

Going into the final day's races at nearby Sandy Cay, our crew was thrilled to realize that our own Al Simmons was seventh in the entire One Design fleet, and was totally dominating the Super Masters (>55) class, while his wife, Susan, was easily leading the Women's Division. Okay, for some reason only one other woman competed this year, but Susan, who is a grandma, was scoring well above her rival and we were mighty proud of her.

With light, shifty winds, the first race around Sandy Cay was a game-changer



LATITUDE/ANDY

**After jibing down Sir Francis Drake Channel, racers plane through Thatch Cay Cut near Tortola's West End.**

for some. And when the leaders turned toward the beach on the final reach, who was in front but ol' Al! Not only had he beaten his perennial friendly rival, Jean-Marc Peyronnet, a lovable self-

proclaimed pirate from St. Martin, but he'd beaten the division's sure winner, past-champion Eli Fuller of Antigua. "All right Al!"

After a final waterside lunch, the breeze filled in nicely for the final race, where Eli's polished technique led to yet another clean win.

Meanwhile in the Open Division, after St. Martin's Ricardy took firsts in races one and two, the 16-year-old Dane, Sebastian Kornum, (who happens to be the Junior World Champion) earned four straight bullets, while his dad, Torben, shadowed him with four straight seconds.

During the awards ceremony that night at The Moorings Mariner Inn, many new friends were seen swapping stories and addresses, while promising to keep in touch. All in all, it had been a fantastic week. The only complaint heard was that it had gone by much too fast.

— latitude/andy

Readers — for details on how to join the 2010 event, see [www.go-hiho.com](http://www.go-hiho.com).

## Fantastic Getaway!

Enjoy a Private Charter on the Yacht *EL DON* in the Sea of Cortez near Loreto Baja, Mexico



- All-inclusive charters for up to 8 guests
- 65' Hatteras Motor Yacht – Crew of 3
- Enjoy wonderful meals, secluded beaches, swimming, snorkeling, hiking, kayaks, marine life, eco-tourism

Contact Gary Noland (925) 623-8755  
[gmnoland@comcast.net](mailto:gmnoland@comcast.net)

[www.LoretoVacationPackage.com](http://www.LoretoVacationPackage.com)

**windworks**  
Sailing & Powerboating

Pacific Northwest

\*Single & Multi-day charters

\*US Sailing certification courses

[windworkssailing.com](http://windworkssailing.com)



Tortola BVI  
Belize  
The Grenadines

**UNIQUELY  
TMM**



Marisa  
TMM Belize

Most charter companies offer blue water & palm trees, but it takes the personalized care of people like Marisa to make your vacation a success.

Like Marisa, everyone at TMM is committed to your complete satisfaction. Our specialized three-location operation offers large company quality with small company service. A combination that is uniquely TMM.

**TMM**  
Yacht Charters  
Since 1979

catamarans • monohulls  
motor yachts  
ownership programs



*"We had a true, worry-free 14 days of sailing. We got everything we asked for... and then some!"*  
BVI Yacht Charters Guest

**Boatshed** BVI.com

- Bareboat, Crewed or Skipped
- Monohulls from 31' to 52'
- Catamarans from 36' to 47'
- Provisioning service available
- Tailored and personal service
- Private Marina
- ASA Instruction
- 24 Hr Emergency Call Out
- Yacht Brokerage
- Beneteau Fractional Programmes
- Free Wifi & Customer Computer

Call us on 284-494-4289  
or visit [www.bviyachtcharters.com](http://www.bviyachtcharters.com)

 BVI YACHT CHARTERS [www.bviyc.com](http://www.bviyc.com)  
THE BOATS. THE SAILING. THE EXPERIENCE...

**BRITISH VIRGIN ISLANDS  
"BEST DEALS ON KEELS"**



- Most selection of sailboats 32'-52'
- "Purr" with cats 38'-47'
- Bare boat or skippered
- Best yacht management program

**Conch Charters**  
Est. 1986

**NEW YACHTS IN FLEET!**

**www.conchcharters.com**  
Email: [sailing@conchcharters.com](mailto:sailing@conchcharters.com)  
Call our 'Sails' Office  
(USA) (800) 521-8939  
Tel (284) 494-4868 • Fax (284) 494-5793

*Sail paradise with Conch Charters*

**CALIFORNIA'S CARIBBEAN CONNECTION**

**Real People. Real Sailing. Real Fun.**



Sail Cats | Power Cats  
Monohulls | Trawlers  
Bareboat | Skippered

**Real Choices.**

Choose CYOA and become part of the family. We've been providing beautifully maintained yachts, personal service and sensible prices to sailors since 1980.



1-800-944-2962  
[info@cyoacharters.com](mailto:info@cyoacharters.com)  
[www.cyoacharters.com](http://www.cyoacharters.com)  
St. Thomas USVI 00802

**CYOA**  
YACHT CHARTERS



Your secret paradise...



in  
*Nicaragua*

Located in a beautiful sheltered lagoon on the north Pacific coast of Nicaragua, Marina Puesta del Sol is your premier cruising destination in Central America.



*Marina Puesta del Sol*  
RESORT

Aserradores, Nicaragua ♦ 011 (from US and Canada) 505-880-0019  
mpuestadelsol@yahoo.com ♦ www.marinapuestadelsol.com ♦ USA 408-588-0017

Ventura Harbor Boatyard, Inc.

*"Quality to set sail with"*



Painting  
Rigging  
Machining  
Welding  
Electrical  
Sandblasting  
Woodwork  
Chandlery  
Custom  
Stainless

Official  
Sponsor  
2009  
BAJA  
HA-HA

1415 Spinnaker Drive, Ventura, CA 93001  
(805) 654-1433 • [www.vhby.com](http://www.vhby.com)

**ANACORTES YACHT CHARTERS**

PACIFIC NORTHWEST ADVENTURES

Largest Selection of  
Charter Yachts in the  
Pacific Northwest

Bareboat &  
Skippered

Power and Sail  
28' - 66'

Charter Yacht  
Ownership

Yachting &  
ASA Sailing Schools

*Celebrating 30 Years*  
1979 - 2009



[www.ayc.com](http://www.ayc.com) 800.233.3004

What's a summer day's cruise  
in the Pacific Northwest?

**Bellhaven  
Charters**

*How about 17 hours of daylight!!!*

Power & Sail Charters  
Crewed or Bareboat  
ASA Sailing School  
Power & Sail Yacht Sales

- San Juans
- Gulf Islands
- Desolation Sound

[www.bellhaven.net](http://www.bellhaven.net)  
[bellhaven@bellhaven.net](mailto:bellhaven@bellhaven.net)

BELLINGHAM, WA

877-310-9471

**Come Check Out Multihull Sailing**



*...a sailing  
experience  
like no other!*

3 trips per day  
7 days a week



**ADVENTURE CAT SAILING CHARTERS**

800.498.4228

[www.adventurecat.com](http://www.adventurecat.com)

Pier 39 • Dock J • San Francisco



**Closest full-service  
charter base to  
Desolation Sound &  
Princess Louisa Inlet**

Visit our Website  
for a preview  
of our 31' to 54'  
Power & Sail fleet

**Check out our Website  
for this month's SPECIAL!**

[charter@desolationsoundyachtcharters.com](mailto:charter@desolationsoundyachtcharters.com)  
[www.desolationsoundyachtcharters.com](http://www.desolationsoundyachtcharters.com)

#101-1819 Beaufort Ave., Comox, BC, CANADA V9M 1R9  
TOLL FREE 1-877-647-3518 FAX (250) 339-2217

# Latitude 38's MEXICO-ONLY CREW LIST PARTY & BAJA HA-HA REUNION



*Make Friends and  
Sail to Mexico!*

## ENCINAL YACHT CLUB

Pacific Marina, Alameda

**Wednesday, September 9 • 6–9 pm**

*(no earlybirds please!)*

**FREE** for registered 2009 Baja Ha-Ha Skippers & First Mates only

**Everyone else pays \$7 at the door** (exact change very helpful)

Apertivos ☀ Guest Experts & Demos

Door Prizes ☀ No Host Bebidas

Everyone welcome ☀ No reservations required ☀ Come as you are

[www.latitude38.com](http://www.latitude38.com) ☀ (415) 383-8200





# CHANGES

With reports this month from **Manu Rere** on almost being lost on a reef in the Marquesas; from **Tawodi** about an unusual and spectacular circumnavigation; from **Geja** on another season of great times in the Med; from **Southern Belle** on family fun in the San Blas Islands; from **Dolphin** on a 'clipper ship' route home from Mexico; from **Sailors Run** on life in Buenos Aires; from **Destiny** on health care in Mexico; and **Cruise Notes**.

## Manu Rere — 38-ft Homebuilt Cat Glenn Tieman I Almost Lost My Cat (Los Angeles)

Since it costs \$25 for three hours of internet time in French Polynesia, my message is going to be short. I arrived in the Marquesas more than three months ago after a great passage from Central America. A *Papagayo* meant I started in very steep seas, but it was followed by a week of light-air sailing. I hove to in the lee of Clipperton Atoll, a pretty desolate place, to enjoy the boiling sea life and earthy scent of guano.



After saving his cat, Glenn had reason to smile.

From Clipperton to the equator I had excessive wind and fast sailing. I towed a tire drogue for several days, which kept things tight and safe. During a calm period south of the equator, I launched my canoe and took a swim to clean the bottom along the wormshoe.

After clearing into the Marquesas, I sailed to Tahuata, where people gave me lots of fruit. The locals were friendly — although not as intimate as at some of the other places I've been to. I enjoyed great hiking in the jungle mountains and swimming in the clear waters. But one night a young man came aboard my boat. Threatening me with a knife and a spear gun, he stole my laptop. The mayor knew who he was and reported it to the *gendarme* in nearby Hiva Oa. But the case awaits a judge from Tahiti, so

*The intrepid Glenn Tieman stands on one hull of the 38-ft cat he built for \$14,000. He nearly lost her on the coral of French Polynesia.*

I'll never get my laptop back.

I'm now in the Tuamotus, enjoying the psychedelic-colored lagoons and drumming and dancing practice at night. But it was here that I almost lost my cat.

The night I arrived, I hung offshore awaiting dawn, within sight of the lights of the village. But I misjudged how close I was to shore. Suddenly *Manu Rere* was bouncing off the concrete-like ridges of dead coral, then slammed to a stop with her bow up at an angle of 20 degrees. As she continued to pound and grind against the coral, I ran to the bow with a bamboo pole and frantically tried to push off. Unfortunately, the bamboo went into a gap in the jagged coral. Having put all my weight behind the thrust, I went overboard! Even though my cat was grinding on coral just 18 inches beneath the surface, I fell into deep water.

"God, I'm going to lose my boat!" I thought to myself. But then I managed to climb onto a block of coral and began pushing my cat toward open water. I managed to get the bow around, then, using the bamboo pole, pushed her from the stern out to sea. Finally, I unsheeted the mizzen, which was aback, and ghosted back out to deeper water.

The saving grace was that it had been very calm for a week, so the sea was nearly flat. Usually, there would have been eight to 10-foot seas slamming into the coral, which certainly would have destroyed my boat. But as it turned out, *Manu Rere* suffered no penetration of the fiberglass to the wood or other significant damage. Life, too, has its jagged ridges and unforeseen depths these days.

— glenn 07/04/09

## Tawodi — Custom 39 Stephen Mann Kathleen Torres Around In Eight Months (San Diego)

When it comes to circumnavigations, Stephen Mann and Kathleen Torres' just-completed sail around the world has to rank as one of the more unusual — and difficult. It wasn't a race, yet it was certainly no pleasure cruise either. Inspired by a wild notion Mann had while returning home from the '00 Singlehanded TransPac, the two sailed what basically was a Vendee Globe route — a long



dash down to the very rough and cold Southern Ocean, around the bottom of the world via the five great capes, then a long dash back up to their San Diego starting point. But rather than sailing the course in a Vendee Open 60, which is very expensive but can often stay up with many of the more powerful fronts that sweep the Southern Ocean, they took Mann's home, a 39-ft Westerly-built sloop that he has so thoroughly modified that neither the designer or builder would recognize her.

Not only did the two choose a strange course for a non-racing circumnavigation, but they covered the 24,000-course — which actually required sailing an additional 4,000 miles — at a dizzying pace. Most circumnavigations take three years, but they finished in just eight months and five days. About 75% of the time was spent sailing, with the other 25% resting or touring. The following is a leg-by-leg account of their trip in case any of you readers want to follow in their wake:





# IN LATITUDES

LATITUDE/RICHARD

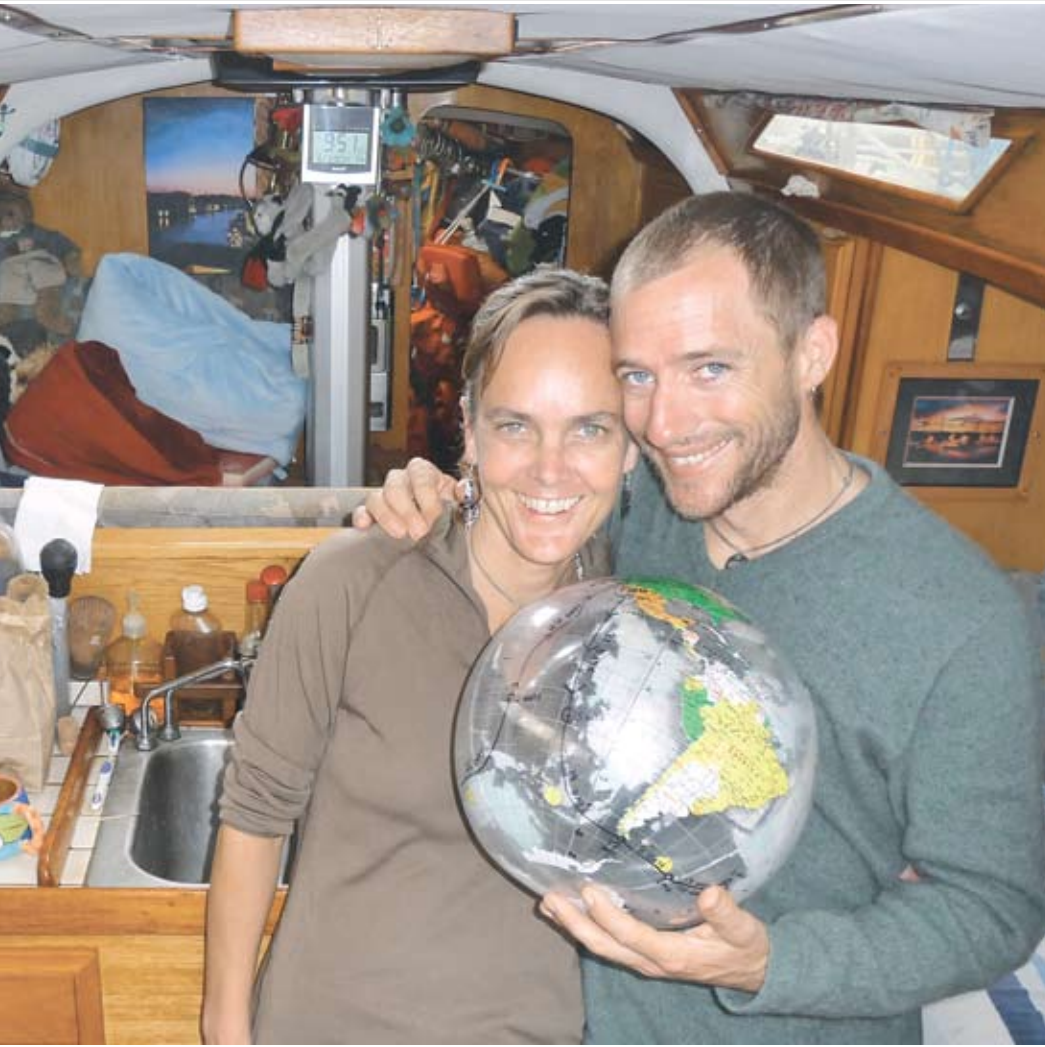

**After a rapid eight-month circumnavigation, Kathleen and Stephen feel as if they have the whole world in their hands.**

— Seven days from San Diego to Cabo, where they stopped for one day to take to take on fuel and inexpensive prescription drugs.

— Thirty-one days from Cabo to Easter Island, where they paused for five days

— Nineteen days from Easter to Cape Horn and around to Ushuaia, Argentina, where they stopped for one day.

— Part of one day from Ushuaia to Puerto Williams, Chile, where they spent 17 days, including Christmas.

— Seven days from the Horn to remote and icy South Georgia Island, where they stayed for two days and where the water temperature was 32 degrees.

— Thirteen days from South Georgia to Tristan de Cunha, which they loved, and where they spent two days replacing the broken pivot between the autopilot and the tiller.

— Thirteen days from Tristan to Cape

Town, South Africa, where they stopped for 11 days.

— Forty-two days from Cape Town to Hobart, Tasmania, where they stopped for nine days.

— Seven days from Hobart to Dunedin, New Zealand, where they stopped for 10 days.

— Twenty-six days from Dunedin to Pitcairn, where they stopped for two days.

— And finally, 27 days from Pitcairn to San Diego.

Whew! And it wasn't as if they could have dallied longer at any of the locations. In order to do the circumnavigation in just one season, they had to start by sailing through the Eastern Pacific hurricane zone before the hurricane season was completely over, and sail back through it on the way home after the next hurricane season had started.

Why take such a strange

route at such a breakneck pace? The 38-year-old Mann, in the manner of Sir Edmund Hillary and other mountain climbers, says "because it was there." But maybe it's because Mann — sort of like singer Tina 'Proud Mary' Turner — doesn't do anything "easy".

As Torres explains, "For Stephen, every activity — such as a bicycle ride to the store — has a finish line and a time to beat." It other words, just sailing around the world wouldn't be enough; he had to do a circumnavigation that included a performance goal and adequate adversity.

Mann accepted his first big sailing challenge in the mid-'80s at the age of 19, when he agreed to sail his dad's 48-ft wooden ketch — actually a converted fishing boat — from La Paz to San Diego. Singlehanded. Battling numerous challenges and facing the adversity of losing the engine, after three long months Mann found himself stuck at Isla San Martin, 100 miles south of San Diego. He was forced to hand over his last \$1,000 to some impecunious cruisers in order to get a tow of the rest of the way.

It proved, however, to be a valuable learning experience. "I discovered that it's absolutely essential to have a boat that can sail well in light air and sail upwind." And that's something that *Tawodi* has been able to do — at least ever since Mann replaced her original funky mast and rigging.

A lot of women readers will probably assume that in addition to being a fine sailor and rigger, Mann must also have

**While they sailed away from remote Tristan de Cunha, their favorite stop, the conditions almost looked idyllic. That would soon change.**



**"Why would anyone with free will come to the islands of the Southern Ocean," wondered the cattle on South Georgia Island.**

TAWODI



TAWODI



# CHANGES

a silver tongue. After all, what else could explain Torres, who had headed up Port Supply in San Diego for West Marine, signing on for such a trip? It turns out she didn't need much convincing.



**'Tawodi' ripping through the Southern Ocean.**

experience."

To fully appreciate what the couple had to go through to finish their unique circumnavigation, you have to visit their website at [www.svtawodi.com](http://www.svtawodi.com). But for right now, let's review just one segment of their trip — say the leg from Cape Town to Hobart.

While at Cape Horn more than a month before, Mann and Torres had the pleasure of meeting French sailing legend Isabelle Autissier. She warned them that the Indian Ocean can be extremely challenging. Mann and Torres were to learn that Autissier wasn't kidding, because it was brutal.

"We had 50-knot winds more than half the time on that passage," says Mann, "and dragged our a drogue until it broke. The problem down there is that a new low comes through almost every three days, and circulates north through south via west. As a result, the seas are not only massive, but completely chaotic. The cauldron-like seas meant that we couldn't get *Tawodi* — which is an 8-

***It doesn't take a lot of ice to sink your circumnavigation, so the time the couple spent sailing through the ice field was nerve-racking.***



Kathleen not only wanted to do the trip, she was excited to go," says Mann. "She used to own her a Pearson Triton up in the Pacific Northwest, lived in a jungle hut in Panama for several seasons, and is generally an adventurous person.

One of her goals was — and is — to write a book about our

knot boat, and which has hit 20 knots — to average much more than 6 knots despite the strong winds. It was nothing like sailing downwind in the Pacific to Hawaii."

Given the sustained strong winds, the seas became the biggest problem. On one occasion, the couple described *Tawodi* as "standing on her tail and being pivoted in the opposite direction." On another occasion, a huge wave picked up their boat and "body slammed" her onto a different wave. It was very rough and relentlessly so.

But there were other problems on that leg. Torres reports that both the air and water were in the low 40s for the entire Indian Ocean leg — cold enough to host a big field of icebergs and bergie bits that they were forced to sail through for several days and nights. "The first couple of icebergs you see in the distance are spectacularly beautiful," Mann says. "But once you've sailed through them for days, and have had to gybe repeatedly to avoid hitting one and being sunk, you'll never want to see another."

"I experienced a lot of sheer terror on that leg," Torres admits. "Yet our number one foe, after the waves, was the incredible condensation and mold that formed inside the boat while we were in the Indian Ocean. Everything not only got wet, it stayed wet and became moldy. It was horrible. When you got dressed to come on watch, it was like having to layer your body with icy cold towels."

Did we mention that the Indian Ocean leg lasted for 42 days?

This isn't to say they didn't have some good sailing. Much of the sailing in the tropics was wonderful, and they were surprised by having a wonderful spinnaker run across the normally tempestuous Tasman Sea. In addition to some fine sailing, they got to see wonderful places — such as Tristan de Cunha — and magnificent wildlife.

"Among the most impressive wildlife we saw were the albatrosses," says Mann. "One thing we learned is that man does not belong in the Southern Ocean, it's just too inhospitable. But the albatross just thrive down there. They are so beautiful!"

The couple had an interesting watch schedule. Mann drove during the day, and tried to get in a lot of miles. Torres would cook the big afternoon meal and then stand the night watches. For Torres, standing watch mostly meant staying in



the cabin and watching the radar and monitoring the autopilot while the boat continued under reduced sail.

Given the combination of arduous voyage and tight quarters, there were naturally moments of tension. "Stephen and I hadn't been living together," says Torres, "so I was used to making my own decisions and he was used to making his. But there can only be one captain on a boat, and it took some getting used to."

And there were times when the adversity didn't help. For example, the ham radio interfered with the operation of the autopilot, so when Mann was making his evening radio check-ins, Torres would have to stand out in the freezing cold and manually steer the boat with the tiller. "It was really cold and hard to steer in the Southern Ocean, so when I heard Stephen down below laughing while in conversation with someone, I could get grumpy, thinking it wasn't the right time for him to be a 'Chatty Kathy'."

One thing that certainly helped the



# IN LATITUDES



ALL PHOTOS COURTESY GEJA



***The lure of the Adriatic is strong for young male sailors because of the fine scenery, great food and naughty girls in the nightclubs.***

couple complete the trip was that they are used to living simple but vigorous lives. For example, everything Mann owns is on his boat, which is now anchored out. Both Mann and Torres are more than just avid cyclists, as she hasn't owned a car in seven years and he hasn't owned one in five years. The couple rarely go out to dinner, don't have a television, and typically see only about one movie per year.

The trip cost about \$10,000, which was most of their discretionary spending money. So now they are back at work, not yet having had time to think about a next adventure. In addition to being a rigger, Mann has a 500-ton license and drives tugs and skippers classic yachts. Torres is already back at Port Supply.

Torres would not do such a trip again. Partly because of things like it blowing 60 knots on her 40th birthday after it

blown 50 knots for the five days before. And partly because of the terror in the Southern Ocean. Mann is different. He now feels much more confident in his abilities and the ability of his boat to take whatever the ocean has to dish out. So yeah, he'd do it again. But for now, both of them are in post-circumnavigation recovery.

We'll let you know when Torres finishes her book, because it's got to be a great story. And she'll also explain why she and Mann, who aren't superstitious, won't ever start a voyage on a Friday again.

— latitude/rs

## **Geja — Islander 36 Andrew Vik and Friends Cruising the Adriatic Sea (San Francisco)**

After an amazing summer cruising the Med aboard *Geja* last year, I've returned for a second season of cruising fun. Readers might remember that

this '76 Islander 36 was sailed most of the way around the world by Dick and Shirley Sandys of Palo Alto. After Dick's death, Shirley sold it sight unseen to a young San Francisco couple, who cruised her in the Med for one summer. I bought her from them.

After I'd wrapped up the last of the winter projects with the mechanics at *Geja's* winter home near Split, Croatia, some Swedish guys, friends of mine from Stockholm, joined me for the first week of easy cruising among the islands of Croatia's

Dalmatian Coast. These 1,000 islands offer great sailing, nearly as many anchorages, and quaint Venetian towns. It is a cruiser's dream — except for the cost. The clean, efficient government-run ACI marinas charge \$70 per night for a 36-footer, and some port authorities even charge as much as \$30 a night just to drop your own hook. Groceries also cost more than in Italy, which is just across the Adriatic. While these high costs have discouraged many cruisers from visiting Croatia, it hasn't deterred thousands of charterers willing to pay these prices throughout the summer months.

Sailing among islands such as Brac, Solta, and Hvar, my Swedish friends and I saw plenty of megayachts in the harbors. The Swedes kept joking that one of these fancy yachts must be full of girls looking for some fun guys to party with. When we reached Hvar, the joke became reality. Just a few boats down the quay

***No sooner had Andrew and his crew Andrew gotten off the boat in Rimini than they were encouraged to join this Pink Night potluck.***



***Italian girls aren't crazy about Brits, but they love Americans.***



GEJA



# CHANGES

from us was a 100-foot motor yacht, whose only guests for a week were nine young Norwegian girls. The yacht was owned by the dad of one of the girls. So when the famous Carpe Diem quayside bar closed for the night, we joined the girls aboard their yacht for a Norwegian *Nachspiel* (after-party). The yacht's crew were reluctant to serve us cocktails, but they did. It was a good night for Intra-Scandinavian relations.



**The Adriatic is full of places for fooling around with boats.**

While Italy's east coast is not known to be very interesting to the cruising sailor, there are a few gems that made it well worth our visit. We made landfall at the town of Vieste on the Gargano Promontory, which is the 'spur' in the boot of Italy. It's a beautiful, bustling town with whitewashed buildings and beautifully eroded cliffs — and it's way off the tourist maps.

Our next stop going up the Italian coast was the Tremiti Islands. This small cluster of islands lies 20 miles or so off the coast, and is home to about 500 people. One island features a massive walled fortress, while another is home to most of the residents. There is little

**Imagine arriving in Venice aboard your own boat — not that you could use her to rub elbows with gondolas in the narrow canals.**



shelter among these islands, so it's possible to stop only in settled weather. The water is as clear as can be — even late in the day we could clearly see the anchor 30 feet down. There is little foreign tourism, so the arrival of two Californians on a sailboat caused a bit of a stir among the locals.

The coast between the Tremiti Islands and Venice to the north is mostly one long flat beach, with shallow water extending quite far out. There is no natural shelter along this coast, which can be a problem during the winter, when storm-force northeast *Bora* winds come howling down the mountains of Croatia. We made stops in little known Numana and Senigallia, where our reception was again warm and the people most helpful. Interestingly, it was usually a plus when we made it clear that we were Californians, not Brits.

Cruising often entails making stops in places for no other reason than that they are a convenient distance from the previous and/or next stops. I find that one of the great joys of cruising is discovering these obscure places.

Charging up the Italian coast, mostly beating and motoring, we finally reached Rimini, known to be one of Italy's best party towns. It advertises itself as nothing less. It has miles and miles and miles of sandy beaches covered with thousands of color-coordinated beach umbrellas. Andrew and I pulled in just in time for the July 4th weekend.

To signal the start of the summer season, the Romagna region declares July 4th to be *Notta Rosa*, or Pink Night, complete with fireworks. The result is that the entire 50-mile stretch of coast turns into one big party! My crew and I purchased the requisite pink shirts and leis, and then started to head off with *Geja's* two folding bikes. We didn't make it far, however, as our dock neighbors insisted that we join their 20-person seafood potluck right there on the dock. These amazingly friendly folks treated us like family, even presenting us with a gift — a skinny two-foot long bottle shaped like an eel covered with Cyrillic writing and containing some unknown liquor. I'm a bit nervous to try it.

After 90 minutes of incredible dockside hospitality, Andrew and I resumed our bike ride into town. By the time we reached the first traffic light, we were swarmed by dozens



of bicyclists in a scene reminiscent of the Critical Mass rides back home in San Francisco — except that cyclists actually stopped at a red light. At the head of the pack were some nice looking local ladies. By the time the light turned green, we had introduced ourselves and were invited to follow them by bike to all of the hottest spots in town! We raced around town with them for hours, dodging an insane mix of buses, cars, mopeds, bikes, and pedestrians. Sadly, an intense Florida-esque thunderstorm cut the night short at 4 a.m.

My German buddy Til Menge joined me for the leg from Rimini northward. Few cruisers are found on the Italian east coast, and securing an allowable spot among the various river ports was often a time-consuming process. The large marinas seldom answered our calls on the radio, and/or didn't even notice that we'd arrived. Still, we had some great sailing — and one gale — from Rimini to Cesenatico, historic Ravenna, and Porto Garibaldi.

Our approach to Chioggia in the Venice Lagoon was exciting, as close reaching in 20 knots gave way to an ominous



# IN LATITUDES



ALL PHOTOS BY GEJA



*Clockwise from above: The Piazza San Marco. Venice at night. Andrew and his friend Til. A little bit of a Richardson Bay look near the Venice lagoon. Hot meats. Hotter young girls.*

black sky — and then to thunder and lighting crackling directly overhead. The southernmost of three entrances to the Venice Lagoon was difficult to identify, and once we did locate it, we had to dodge a tanker exiting the narrow channel while being rolled about by confused seas meeting the out-flowing water from the lagoon. *Geja* handled it all well, and has no doubt seen worse in her tens of thousands of ocean miles.

After a night in the canal town of Chioggia, we motored the final 15 miles within the Venice lagoon to Venice itself. What an experience to approach Venice by boat! I'd never been to Venice, and was not prepared for the excitement of sailing past the famous Piazza San Marco and other historic attractions along the town's waterfront. With due respect to my native San Francisco, Venice must be the greatest urban boating venue in the world.

I'll explore the Venice lagoon for a week before continuing my clockwise voyage through the Adriatic Sea. I will then return to 'The East', meaning Slo-

venia and Croatia. The summer party season there begins soon, and I sure don't want to miss any of it! Nonetheless, I'm sure going to miss the warmth and friendliness of the Italians.

— *andrew 07/15/09*

## **Southern Belle — F/P 42 Cat The Salley Family San Blas Islands (Newport Beach)**

After staying in Panama's Shelter Bay Marina for two days, we — George, Melinda and our eight-year-old son Joshua — took off for what would be three magical months in the San Blas Islands on the Caribbean side of Panama. Marina life is okay, but for us, island time is better. David Katz, our friend and longtime crewmember, joined us for the 2.5-day trip out to the San Blas Islands.

On our first day out of Colon, we made it to Portobello, home of the mushroom. Just kidding. Portobello was actu-

ally 'discovered' by Columbus, and from 1570 to 1700 was the major base from which the Spanish transported the gold and silver they'd plundered from South and Central America to Spain. As such, Portobello was a fortified city, with forts on both sides of the bay. We visited the ruins of the battery of Fort San Fernando on the north side of the bay. From our vantage point on the upper level of the fort, we could easily envision how it was when the dreaded pirate Henry Morgan and his troops came to attack.

Our first anchorage in the San Blas Islands was at the East Lemon Cays, right between the islands of Banedup and Nuinudup. The indigenous people of the San Blas Islands are called Kuna Indians, and they refer to their island paradise home as Kuna Yala. It stretches approximately 130 miles along Panama's Caribbean coast, and comprises over 340 coral islands. Crystal clear water and beautiful living coral reefs abound in the western half of Kuna Yala, which is all we've had a chance to explore so far. The Kunas are nearly as short as the pygmies of Africa, but are unique in that they are the only Amerindians to have resisted five centuries of invasions to gain real autonomy over their territory.

What have our highlights been in the San Blas?

— Snorkeling! The clarity of the water combined with the variety of sea life and coral is absolutely astounding. Nothing we've seen to date comes close to matching the underwater beauty of Kuna Yala.

— Participating in the Kuna Regatta at Banedup Island. The locals race their sailing canoes, called *ulus*, in a regatta followed by a happy hour and a dinner party. Cruiser volunteers were invited to crew on the *ulus*, and Melinda competed with a group of ladies. They even ***Eight-year-old Joshua of 'Southern Belle' over-looks the best summertime 'swimming hole' that any boy could imagine.***



SOUTHERN BELLE



# CHANGES

had a bead on first place before running aground on a shallow reef near the finish.

— Exploring the mountains and rivers on the mainland territory of Kuna



**The big guy was shocked at the size of crab claws in the San Blas Islands.**

Yala. Our river hike on the Rio Sidra took us up to a nice waterfall with a swimming hole. We had fun hiking back down the river, as it required us to jump off several waterfalls and swim across pools to ford the river.

— Mola shopping. Molas are colorful cloth panels made up of three to five layers of reverse applique, one on top of the other. Molas typically reflect scenes from Kuna life or animals or plants, and it can take as much as two to five weeks to make one. At every anchorage you'll be approached by several Kuna women in an *ulu* hoping to sell you a mola.

— The numerous cruiser functions at the different islands. For example, there was Cajun Night on Banedup, where Melinda prepared chicken and sausage gumbo for over 40 people. Then there were the Monday night happy hours on 'BBQ Island', and Texas Night in the Coco Banderas, where we celebrated the birthday of Sam Houston. And we can't forget the two *gringos* from Chicago who got married on Banedup Island in the Kuna tradition. This is how the Kuna Yala get married: The groom is placed in a hammock, then a bunch of people pick up the bride and put her in the hammock with him. The bride then jumps up and runs away. The men of the village chase her down and bring her back to the

**When taken out for a sail aboard 'Southern Belle', these Kuna kids proved to be wonderful guests.**

hammock. After she is returned to the hammock for the third time, the couple is considered to be married.

— Becoming best friends with the folks on the Prout catamaran *Toucan* — Mike and Mary, who are from the mountains of Colorado near Telluride, and their children Noah, 10, Lydia, 8, and Eva, 5. We met them while anchored near each other. The kids got together to build a secret fort on the islands, after which they became fast friends. We had a great time hanging with *Toucan* for over six weeks.

We are currently in Cartagena, Colombia, picking coca leaves for the local cartel. Just kidding again. Cartagena is actually a lovely and historic city, and we've met many friendly people. We will be travelling in South America for a couple of months while *Southern Belle* waits patiently for us in Cartagena. After that, we're headed back to the San Blas Islands, which we think are easily one of the most beautiful places on earth. In fact, we may even do some charters in the San Blas!

— melinda 07/05/09

## **Dolphin — Islander 44 Skip and Dantel White The Clipper Route Home (Arroyo Grande)**

Thank you *Latitude* for being a great read every month. You showed me that an 'Average Joe' such as myself could cruise, and provided me with the motivation to make it happen. More recently, I have enjoyed downloading *Latitude* via wifi while on the hook in Mexico.

I'm writing to perhaps inspire others to consider the offshore or clipper route from Cabo up to San Diego as an alternative to the traditional Baja Bash along the coast. After three seasons based out of Banderas Bay, but with future plans to cruise the South Pacific, I wanted to learn how to improve my boat by sailing north via the offshore route. Before my wife and I left on May 29, I studied the pilot charts and made what I thought were reasonable waypoints based on not exceeding a presumed 45% beat.

While still at anchor in Cabo, I dinghied over to the beautiful yellow hulled ketch *Kalona*, and learned that Bob, her owner, had made three previous clipper route trips back to California, and was planning to do another as soon as the weather looked good. Bob had kept his previous tracks on the same chart



in different colors, so his passages were easy to analyze. In addition to giving me confidence, Bob's previous tracks pretty much confirmed the waypoints I had selected earlier. In any event, I knew that I would not tack back to port until I neared 27N, 123W.

We watched the weather for days before our departure, making certain there were no tropical storm threats offshore of Mazanillo, since our offshore route meant we'd actually be putting in some south before tacking back over to go north. This would put us within 150 nautical miles of 'hurricane alley', an imaginary line between Isla Socorro and Hawaii. We were also looking for fair weather along the Baja coast.

The evening before we departed, Terry from *Ishi* kayaked over to tell us a little of her and her husband Gary's experiences, as they had done eight clipper route trips back to California — and were going to start another the day after we left. I learned they had run out of wind and had to motor nearly half the times







JAY AILWORTH

**Prior to taking the offshore route back to California, Skip and Dantel's Islander 44 'Dolphin' looked sweet in the Banderas Bay Regatta.**

they had taken the offshore route.

We left for the first time on May 27 with *Koho*, which was headed for Hawaii, and three other boats that would be doing the traditional Baja Bash. After *Koho* reported 50 knots of wind just 13 miles outside of Cabo, we all turned back. We all left again on the 29th.

It took us 13 days and 1,355 miles to reach Ensenada on our second attempt, even though we lost the use of our Perkins diesel on Day 4. Our best 24-hour run was 170 miles, which was on the second day out. Our worst day was 60 miles on Day 5. The farthest offshore we got was 420 miles. We saw 27 knots of wind when leaving Cabo Falso, but no more than Force 4 after that. We were becalmed a total of 18 hours. We made our final tack back to port at 26.15N; 122.29W. Having only done this passage once, I have no idea if these are average times and distances.

We arrived in Ensenada prior to several boats that had left Cabo the same time as we did to do the Bash.

By the way, I want to take this opportunity to give a shout to my crew for their help during the Banderas Bay Regatta — Tim of *Midnight Blue*, Cary and Michelle from Mammoth Mountain, Sean 'the "go to" guy in Sayulita,' and Clive and Steve, a couple of P.V. sailors. Thanks, guys, for making a great regatta even better!

— skip 06/29/09

**Sailors Run — Baba 40  
Jeff and Debbie Hartjoy  
Land of Steak & Leather  
(Longbranch, WA)**

During our first three months in Argentina, Debbie and I tried hard to see what we could of beautiful Buenos Aires, the fifth largest city in the world. But time just seemed to slip away, as we worked to get *Sailors Run* back into shape after a hard year of cruising — including my solo 4,500-mile

rounding of Cape Horn. We decided that it was time to change our priorities and get to know Buenos Aires.

Located at 37 degrees south — almost the same latitude as San Francisco — Buenos Aires has a great climate. The summers are hot, the winters are mild, and the rainfall is spread evenly over the year.

We quickly learned that Spanish is the local language, and at first it seemed odd seeing light-skinned, blue-eyed, blonde people rattling away in Spanish but not knowing a word of English. If you don't speak Spanish in Buenos Aires, you'll quickly feel isolated. The locals are very friendly and helpful, but hardly anybody speaks English, and few are interested in trying to learn. Thanks once again to Debbie's fluency in Spanish, we did just fine. We have met many interesting and helpful locals here, often times being driven around the city to get things we need, do shopping and so forth.

The vast majority of the 13 million residents of Buenos Aires are European looking and are very proud to be Argentinian. Few of them speak of their not-so-distant ties to Italy, Portugal, Spain, England, Germany or Switzerland.

Argentines are thin, energetic and very athletic. No matter the time of day or evening, you see countless runners. If anyone was looking to find a perfect '10' physique, male or female, Buenos Aires would be a great place to start. But not all of it is natural. Apparently more people here go under the knife to maintain or enhance their beauty than anywhere else in the world. Men, it's reported, are the more frequent users of these services.

One of the things we prefer not to do in Buenos Aires is walk city streets Monday through Friday. It's dangerous!

**Buenos Aires, the biggest city in South American, looks vaguely like New York City — but it has a much greater population.**



ARGIE SNAPS



# CHANGES

First, pedestrians do not have the right away, so 400 of them are killed on city streets each year. As if the cars weren't a big enough danger, you always have



**"Buddy can you spare me some bucks for some boobs?"**

to be on guard against thieves. I had to smack one guy who was unzipping Debbie's backpack as she walked in front of me. When I yelled at him, he looked at me in disbelief. I have a hard time standing by and watching thieves dip into the purses of elderly ladies, but locals just seem to clutch their own bags tighter and move along. Other than petty crime and cars trying to run you down, the city feels pretty safe. Debbie and I have strolled the streets at all hours and never had a problem.

Buenos Aires is a beautiful city, with many wonderful sites, parks, museums and theaters. Apparently a building boom is just winding down, as many large new buildings are just being completed.

Based on historical experience, the Argentinians have little faith in their government, as there is much corruption and there have been numerous booms and busts. Back in the '20s, for example, the gross national product of Argentina exceeded that of Germany and France. The people believe it's simply their fate to prosper only to suffer once again — as when the banks failed back in '01 and people lost their wealth overnight. We won't even mention the Dirty War of '78, when the very conservative government had the military fly members of the opposition over the Rio Plata and push them out of the planes. Because of this, the Argentinians march forward with a philosophy of living intensely for each day because the next one might not be **Argentinian beef, particularly when lightly cooked, has a long history of causing vegetarians to 'lose their religion'.**

so good.

There are big cultural differences between Argentina and the States. For example, a typical workday is 12 hours long. Dinner starts about 8 p.m., but doesn't really get going until around 10 p.m. The dancing and partying on weekends doesn't get going until about midnight, and you're not thought to have had fun unless you party until the sun comes up. It hasn't been unusual for Debbie and me to see people still drinking in the parks when we start running at 8 a.m.

Argentina is justifiably known for its beef. We can buy hamburger for 50 cents/pound, while New York cut steaks for the 'barbie' are just \$1/pound. And yes, our cholesterol is on the rise. A by-product of raising and killing all the cattle is leather goods. Everywhere you look there are leather goods, most of it the highest quality we have ever seen.

Debbie and I recently made the six-hour sail across the Rio Plata to Colonia, Uruguay. It's a warm and quiet little town, with safe moorings for our boat. This has resulted in our deciding that we need to spend more time here, so we've come up with a new — what a surprise! — plan. We're going to spend the next year bouncing back and forth between Uruguay and Argentina every three months. To help with our explorations of these two beautiful countries, we've purchased a brand new 125cc Zanelle motorcycle.

Debbie is a smart and great mate, so she knows that keeping this sailor and *Sailors Run* up a river for a year can make me pretty antsy. So she has agreed that once we leave here in June of '10, we'll spend four months along the coast of Brazil, then set off across the Atlantic via the Azores to Spain. Yes, Debbie is willing to make another long ocean crossing in order to see where her ancestors on her father's side came from. Of course, once in Europe there will no doubt be many more opportunities to see other places in the area. Isn't life great?!

— jeff 06/09/09

## **Destiny — Catalina 42 John and Gilly Foy Health Care In Mexico (Alameda / Punta Mita, MX)**

John and I continue to be more than pleased with the health care we've been getting here in Mexico. A couple of months ago, I went to a dermatologist because of my lousy fair skin, and had 30 small pre-cancer growths burned (frozen)



off. Based on previous experiences in the States, despite the fact I had insurance, it would have cost me \$250 out-of-pocket, and my visit would have been a maximum of 10 to 15 minutes. Here in Puerto Vallarta, I saw a young doctor who is fluent in English, and who spent an hour giving me a thorough examination — including my head and my toes. I walked away with a single bill of 800 pesos — about \$61.

Last week I went to see a gynecologist, who was also young and spoke good English. She spent about 50 minutes with me, did a pap smear, and asked me more questions than I can remember a doctor's ever asking me before. Once again, the total came to 800 pesos or about \$61 — including the pap smear and subsequent lab work. I was very impressed, as she seemed to have a good grasp of modern women's medicine.

The gynecologist sent me to have five blood tests — including for cancer antigens — and the total cost was just \$260. I'm still getting bills for lab work done in the States a year ago, so it was great to be able to just go in, have whatever was



KARL GASTON SMITH



# IN LATITUDES



LATITUDE/NICK

**Anchoring off the face of Catalina near Avalon can be tricky because of the deep and often choppy water. The Dana Point-based 'Rubiyat', which appears to be a Columbia 34, fell victim to the conditions in July. She couldn't be pulled free because she was holed. Be careful out there!**

needed done, pay, and have done with it. Dealing with insurance companies in the States is like getting nibbled to death by a duck.

I got my doctor's name through Pamela Thompson at Vallarta HealthCare Resources. You can Google that organization for contact information. Here are some other sample prices: Complete mammogram with a female technician, plus a manual examination by an oncologist, about \$60. Skin clinic check from scalp to toes by an oncologist, about \$20. Colonoscopy — just get it over with! — about \$290, not including the cost of any biopsies, if necessary.

Anyway, we're loving Mexico, and the health care we've both received here.

— gilly 07/19/09

## Cruise Notes:

What to do **if it 'all goes to shit'**? That's the question we asked in last October's issue, when it looked as though the U.S. and global economies

were close to an Armageddon-like meltdown. While it appears that the ultimate meltdown has been at least temporarily avoided, experts agree that neither the U.S. nor global economies are poised for anything resembling a strong post-recession recovery. As such, our advice is the same that we gave last year: If you've got a boat, but don't have a job or family obligations that require you remain in the States, there are three reasons you might want to consider spending the winter cruising in Mexico: 1) It's much less expensive cruising down there than it is trying to survive up here. In fact, we know several folks who cruised like kings last season on unemployment benefits. 2) It's more fun. And, 3) If you take advantage of all the opportunities, it's a much more healthful lifestyle, too.

There's no apparent slump for the 24th running of the **Atlantic Rally for Cruisers**, the 2,700-mile rally that departs the Canary Islands on November 22nd for St. Lucia in the Lesser Antilles. With all 225 ARC slots having been taken, the organizers of the granddaddy of all cruising rallies have started a waiting list. A total of 28 countries will be represented in this year's event. While there is a small racing division where entries aren't allowed to use engines, the overwhelming number of folks are entered in the cruising divisions. Most cruising boats make the crossing, which is almost always downwind in warm trades, in 13 to 21 days. There are only eight U.S. entries this year, which we believe is a record low. To our knowledge none of them is from the West Coast.

A little closer to home, November 2 start will mark the 20th anniversary of Steve Black's **Caribbean 1500**, which takes the cruising fleet from Hampton, VA, to Tortola in the British Virgins. So far 35 boats have signed up, none of them from the West Coast. Entries in this event typically take six to 13 days to finish what's almost always a much more difficult trip to the tropics than is the Ha-Ha.

"It's hard for us to believe that after 5,500+ miles and 18 months, our adventures in the Pacific Northwest and Alaska are coming to a close," report Dick and Sherry Drechsler of the Long Beach-based Catalina 470 **Last Resort**. "It's with a heavy heart that we leave behind the many friends that we made, and the spectacular scenery. At least we managed to backtrack far enough north to visit Princess Louisa Inlet, one of the spectacular fiords that we'd missed last year. It was definitely the highlight of the scenery we've seen this spring, and puts the crown on our voyages in this majestic **Junction Island, near the entrance to spectacularly beautiful Princess Louisa Inlet, the latter being the highlight of the Drechsler's season.**



MILTON FRIEDMAN



# CHANGES

tic wonderland. But at the same time, visions of swaying palm trees and white sand beaches call for us to head south. Our goal over the next six months will be to sail to San Diego, join the Ha-Ha to begin our winter cruise in Mexico, and meet new friends in 2,600-mile distant Puerto Vallarta for New Year's Eve."

One of the interesting things about cruisers is that, as a group, an unusually high percentage have had to overcome physical ailments to pursue their sailing pleasure. Dick is one of them. Although he's a survivor of throat cancer, he was left with a very narrow opening between his mouth and his stomach. As a result, his diet consists entirely of Slim Fast drinks and water. It's something for all of us to remember when we start to wallow in self-pity.

Sailing can be the ticket to seeing the world — even if you don't own a boat or have a lot of money. Just ask **Grant Howerton** of landlocked Fresno, who is seen in the accompanying photo aboard the *Bounty* replica at Hamilton Harbor, Bermuda. Grant learned to sail while attending San Francisco State University,



PHUZZYPHOCUS PERKINS

**Grant Howerton, originally from Fresno, takes a break before being part of the 'Bounty' crew in the Tall Ships Atlantic Challenge.**

and later used the *Latitude* Crew List to score a berth in the '08 Ha-Ha aboard Chad and Caroline Carvey's Sausalito-based Hans Christian 43 **Tambadil**. But that was just the start. Returning to

Northern California, he became a sailing instructor at the Treasure Island Sailing Center. He subsequently signed up for the 2009 Tall Ships Atlantic Challenge aboard *Bounty*, which is why he was in Bermuda last month. Once he's crossed the Atlantic, he'll have punched his ticket for countless other sailing opportunities around the globe. All this is as reported by Mitch 'Phuzzyphocus' Perkins.

It looks as though another **El Niño** — meaning a warming of the water temperatures in the Central and Eastern Pacific — is underway. El Niño conditions have a variety of impacts around the globe, although they are difficult to predict and measure. Often the condition results in the intensification of upper-level westerly winds, which tends to suppress the development of summer hurricanes in the Caribbean/Atlantic. That's a good news. In the winter, however, the intensified westerlies often mean that the trajectory of the North Pacific jetstream is flattened and moves farther south, which usually results in more warm winter storms across Southern California and

## Your Boatyard in the Heart of Paradise



Large, fenced, secure dry storage area

**Tahiti Customs policy has changed!**  
Foreign Flag vessels can stay on dry storage in our yard for up to 12 months out of 24.



A Subsidiary of  
The Moorings Yacht Charter, Ltd.

### Our Services |

#### HAULOUT

- Marine Travelift 25 tons
- Marine railway 120 tons
- Storage in adjustable steel cradles
- Fenced Yard

#### PAINTING

- Topsides, hull, bottom, varnish
- Brush, roller, spray

#### MECHANICAL WORK

- Inboard, outboard, diesel, gas
- All brands

#### REPAIRS

- Electrical repairs
- Refrigeration installation & repair
- Fiberglass & woodwork
- Welding, steel, stainless, aluminum

#### SAIL LOFT

- Sail repairs, biminis, dodgers, covers

#### STORE

- International, Pettit, Epiglass, Devoe
- Spares
- Fill U.S. gas cylinders

#### DO-IT-YOURSELFERS WELCOME!

*BoatUS Cooperating Marina*



Professional boatyard in the heart of Paradise

*Raiatea Carenage will make sure paradise is everything you expected. Call, write, or sail in . . . we're here to serve you.*

B.P. 1111 Uturoa Raiatea 98 735 Polynésie Française

Tel: (689) 600-545 ~ Fax: (689) 600-546 ~ VHF 68

Web site: <http://www.raiatea.com/carenage> ~ email: [raiataecarenage@mail.pf](mailto:raiataecarenage@mail.pf)

the southeastern United States. One of the El Niños about 25 years ago savaged the Southern California coast. On the other hand, the Pacific Northwest is often warmer and drier in El Niño years. For weather forecasters, the puzzling thing about El Niños is that they often seem to have the most severe effects when the El Niño condition itself isn't particularly severe. In other words, our understanding of El Niño is, if you'll excuse the pun, in its infancy.

Capt. Marc Wilson reports he's finally taken delivery, for the owners, of the new Catana 50 **Bright Wing**. True, the boat was supposed to be delivered eight months ago in France, but July in the Pacific Northwest was better than nothing — especially since everyone seems to be happy with the workmanship. Wilson complains that the same can't be said about their new Aqua Pro inflatable. "The transom mounting plate sheered off our less-than-20-minutes-old Aqua Pro inflatable, taking our less-than-20-minutes-old outboard to the bottom with it!" says Wilson. "The best part is

that there is a padeye on the plate to attach the motor to in case the motor comes off! Aqua Pro somehow claims they are not responsible for the failure."

Can you guess what the following numbers — 154, 222, 190, 157, 157, 151, 154, 205, 193, 184, 204, 227 and 186 — represent? The first 12 are the daily runs, with the last one being the average day's run, of Steve and Dorothy Darden's crossing from San Francisco to Hawaii in July aboard their Morrelli & Melvin 52 **Adagio**. Shaun Peck was along as crew. In 18 to 22 knots of wind, the Dardens reported that *Adagio* slid along at between 9 and 13 knots under a main or reefed main and a large reacher. They sailed the whole way with the 'back door'



*Having just made Honolulu, Steve and Dorothy Darden can't wait to get back to the rugged landscape of their adopted home of Tasmania.*

to the large cockpit open day and night, which allowed them to read or socialize while sailing. *Adagio* was launched in Opua, New Zealand, in '00, and the Dardens have since cruised her 30,000 miles in the Pacific. After several wonderful seasons in Tasmania, they sailed to Alaska via New Zealand, Tahiti and

## Pier 32 Marina - Your Cruiser's Headquarters



*We hosted the largest contingent of Baja Ha-Ha Cruisers in San Diego in 2008!*



*Passing through or want to stay in beautiful San Diego forever? Our world class accommodations await you. We also have a business center to check your computer; we'll help you with faxes, copies and information.*

**Baja Ha-Ha Special-Have a free night on us and a pre Ha-Ha party**

- 28' - 60' slips
- Deluxe shower rooms
- Spacious laundry facilities
- Exercise/workout center
- Boater's Lounge
- High speed internet
- BBQ areas

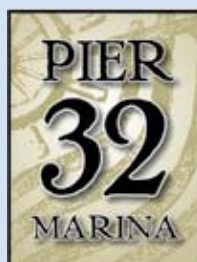

3201 Marina Way  
National City CA 91950  
**Call 619-477-3232**  
**or 800-729-7547**  
office@pier32marina.com  
www.pier32marina.com



# CHANGES

Hawaii. After several seasons in Alaska and the Pacific Northwest, the couple returned to San Francisco Bay for the summer. They are now headed back to Hobart, Tasmania, which they consider to be their homeport.

"We finally left St. Martin and visited St. Barth for a week or so," write former Bay Area residents Mark and Liesbet Collaert of the Tobago 35 **Irie**. "St. Barth is clean, attractive and you can get everywhere on land by foot or thumb, so we can understand why the publisher of *Latitude* likes it so much. In addition, the people are friendly and the island has a pleasant village-like atmosphere. Our favorite anchorage was Columbier, which has free moorings, a nice beach, and quiet surroundings. We did spend one night in Gustavia, and even though we expected to pay something, we were surprised that the fee came to 12 euros—or about \$20. It was so much because they charge by volume of the boat, and our cat is much larger than a monohull. So back we went to Columbier, where the moorings are free. After enjoying St. Barth a lot, we continued on to Antigua, where we had a little episode with our



LATITUDE/NICK

**Our favorite free anchorage at St. Barth is Baie St. Jean — at least as long as none of the planes get snagged in the mast of our boat.**

dog. Our next stop was Guadeloupe, where we spent a great week in the 'suburb' of The Saintes, which are a group of nearby islands. We've just arrived at Dominica, for which we have high ex-

pectations. But a tropical wave has been passing through, so all we've seen so far is rain. We hope to enjoy going inland before having to rush down to Grenada for hurricane season."

In addition to Columbier, visitors to St. Barth can also anchor for free at Shell Beach, Grand Saline and Baie St. Jean. None of these places are as convenient as Gustavia, but they're all sweet. By the way, we've been advised that "all the rooms and hotels are sold out on St. Barth for the first two weeks in November." It's all because of two events. The first, to be held November 6-8, is the 60th anniversary of Marius Stackelborough's **Le Select Bar**, probably the most famous watering hole in the Caribbean. Born in 1923, our friend Marius is a one-of-a-kind. People flew in from all over the world for the 50th anniversary of Le Select, and they'll be doing the same for the 60th. Among the many musicians playing will be Marius' longtime and dear friend **Jimmy Buffett**, who apparently is hosting a free blues festival at about the same time.

It's been a busy nine years for Jim

## Be Safe

### AVOID COLLISIONS



**AIS WatchMate®**

"A really amazing piece of gear. I can tell it was designed by a sailor?"

*John Majewski, Skoier IV*

[www.aiswatchmate.com](http://www.aiswatchmate.com)

vespermarine

(858) 405-5810

## ¡Hola! Baja Ha-Ha Cruisers

Before You Baja Ha-Ha, Stay at Chula!

### Baja Ha-Ha Cruiser's Special

Up to 3 months at \$16 per foot  
**FREE Liveboard for 2**

*Subject to Availability*

First-class yacht marina amenities  
at a reasonable price  
Gourmet restaurants...Heated pool & spa

We're your best value on the Bay in San Diego

## CHULA VISTA MARINA

**619-862-2819**

550 Marina Parkway • Chula Vista, CA 91910

[www.chulavistamarina.com](http://www.chulavistamarina.com)

[boatslips@cvmarina.com](mailto:boatslips@cvmarina.com)



and Jo Patrick of Orinda, as they spent part of the time working and part of the time cruising their 52-ft **Starrlite**. Starting from Bermuda, they have traveled to the following places: In '01, Bermuda, Azores, England, France, Belgium and Holland. In '02, Holland, Germany, Denmark, Sweden, Finland and Norway. In '03, Norway, England, Scotland, Ireland, France, Spain, Portugal and Gibraltar. In '04, Gibraltar, Spain, France, Italy, Montenegro and Croatia. In '05, Croatia, Italy, Tunisia, France, Spain, Bermuda and Maryland. In '06, Maryland, Delaware, and New York. In '07, New York, Canada, Michigan, Wisconsin and Illinois. In '08, Illinois, Missouri, Ohio, Kentucky, Tennessee and Mississippi. And in '09, Mississippi, Alabama, Louisiana, Texas and California. When they passed under the Golden Gate on August 1, it was expected that there would be a large crowd of well-wishers on the bridge to welcome them home, including the Boobah Boys Band, of which Jim is normally a member. The cheering was to be followed by a party at the St. Francis YC to celebrate the completion of their

voyage and Jim and Jo's 44th anniversary.

Congratulations are due the Arnold family — parents Geoff and Karen, and teenage daughters Claire and Alex — for having arrived back in Brisbane following a nearly three-year circumnavigation aboard their Dufour 4400 **Fafner**. The Arnolds started their trip around the world with Ha-Ha 13, and actually tied the knot in the Marquesas a few months ago. An unusual feature of their trip around is that they returned home from the Med via the Straits of Magellan and the Central Pacific as opposed to the Panama Canal. We hope to have more on their trip in the next issue.

"I just want to say 'hi' to everybody," writes Liz Clark of the Santa Barbara-based Cal 40 **Swell**, which is currently



COURTESY SWELL

**One of the neat things about Liz Clark is that she's still got a kid-like quality — as also evidenced by the dorm-like interior of 'Swell'.**

in French Polynesia. "Thanks to \$1,400 in generous donations from *Latitude* readers, I'm well on my way to getting the funds I need to repair *Swell's* slow leak. She's already been hauled and I will undertake repairs as soon as I get back to her from California. I thank all of you so much, and I promise to try to

## OPEQUIMAR

MARINE CENTER ~ CENTRO MARINO

88-ton (max)  
Travelift!  
Length to 100'  
Width to 23'

Puerto Vallarta, Jalisco, Mexico  
Paseo de la Marina Sur #214 • Marina Vallarta, 48354  
Tel: 011 52 (322) 221 1800 Fax: 011 52 (322) 221 1978  
email: [info@opequimar.com](mailto:info@opequimar.com)

Visit Our  
Yacht Club!

Opequimar Yacht Club

First Class • Full Service  
On site dining, Internet, socials

BOAT SALES  
NEW & USED BROKERAGE  
[www.opequimar.com](http://www.opequimar.com)

We make boating more fun!

A KONGSBERG Company

marine paint

Come to Mexico,  
Enjoy the Mexican Riviera,  
Repair your boat at  
**OPEQUIMAR**



# CHANGES

keep the loop of generosity circular in every way that I can."

Ah, the 'loop of generosity.' When we were 15, we hitchhiked from the Bay Area to Canada to work at a camp. The next summer we hitchhiked to another summer job in Colorado and back. You obviously can't do stuff like that today, but people were so generous to us back then that we've never forgotten it. Indeed, it's one of the reasons we try to take as many people as possible sailing — especially younger folks with little money to spare — on *Profligate*.

Last month William Nokes of the Brookings, Oregon-based Gulfstar 41 **Someday** reported that he was in Costa Rica for the summer. We expressed the opinion that Costa Rica, like the rest of the Pacific Coast of Central America, isn't the best place for a boat at that time of year. Noke's most recent report explains why:

"From Puntarenas, Costa Rica, to San Juan del Sur, Nicaragua, the three of us survived several severe thunderstorms. The first night out we were in the throes of a severe rain and wind storm, when



BENNY FRANKLIN

***In the summer, the coast of Central America gets hit by more lightning than almost any place in the world. Be careful!***

a 'wall' of storm appeared in front of us. Radar shows only intense rain, so you have to extrapolate the other information. But when all you can see is a huge storm off your bow an hour ahead of

you, you need to tighten your shorts and make some decisions. My decision was to retreat, so we returned to spectacularly beautiful Bahia de Ballena, which offers pretty good protection. We had no trouble at anchor, so we started out again in the morning. It was no problem until early in the evening when we neared the south end of the Gulf of Papagayo and encountered more storms. The nature of these coastal storms seems to be that they start at the line of hills as the sun heats the land. As long as the daily diurnal winds are blowing onshore, they stay on shore. But once the wind weakens, the storms — which are already throwing a lot of spikes of fire — start to migrate wherever they want to go, usually not more than 10 miles offshore. The huge dark shapes that you have to travel under become scarier as you realize that your boat's mast is by far the tallest thing for miles, and each lightning bolt — which can power a city for several days — can zap you into history in a pico second.

"You make attempts to avoid the worst

**ENJOY 5 STAR  
RESORT AMENITIES  
AT \$10.40 PER FOOT**

	Foot	ANNUAL Price/ft in other Marinas in Southern CA	ANNUAL Price/ft in Hotel Coral & Marina Ensenada, Mexico	ANNUAL SAVINGS!
		\$17.00	\$10.40*	
Slip Size	45	\$9,180.00	\$6,291.00	\$2,889.00
Slip Size	50	\$10,200.00	\$6,990.00	\$3,210.00
Slip Size	55	\$11,220.00	\$7,689.00	\$3,531.00
Slip Size	65	\$13,260.00	\$9,087.00	\$4,173.00
End Ties	64, 79, 95, 99, 109		\$12.00*	

\* Plus tax

The only fuel dock & best launch ramp in Ensenada  
Concrete docks from 30' to 65' with 100v / 220v elect.  
Water, cable tv & phone hookups, free wireless internet  
Laundry, marine chandlery  
Shuttle service available to and from Marina Coral - San Diego (Shelter Island area)

**HOTEL CORAL  
AND MARINA**

Reservations toll free: 1 (866) 302-0066 | F 01152 (646) 175-0058 | VHF 71 | Carretera Tijuana-Ensenada Km. 103, No. 3421 Zona Playitas, Ensenada, B.C. C.P. 22860 | [marina@hotelcoral.com](mailto:marina@hotelcoral.com) | [www.hotelcoral.com](http://www.hotelcoral.com)

**MARINA REAL**  
SAN CARLOS, SONORA, MEXICO

**IN THE SEA OF CORTEZ**  
Located on the Mexican mainland near Guaymas and San Carlos, 265 miles south of Nogales, Arizona.

- 350 slip marina • 20 & 30 amps electrical service
- 24-hour security patrol
- Fuel dock with gasoline/diesel
- Restrooms & showers
- Web email • Fax/copy service
- Port entry clearance
- Book exchange • Video loan library
- Ice & bottled water
- Wet storage for summer months (low prices)

**Now Offering:  
Haulouts, Dry Storage & Service Yard**

  
marina Real

Phone/fax 011-52-622-22700 | I  
Call on VHF #16 when in area  
email: [marinareal@prodigy.net.mx](mailto:marinareal@prodigy.net.mx)  
Visit our website:  
[www.marinareal.bravehost.com](http://www.marinareal.bravehost.com)

of the patches of black ahead of you," Nokes continues, "but to your complete astonishment, one will form over you where a minute before it was clear with stars. Suddenly the wind picks up and the temperature drops at least 20 degrees. The wind strengthens to maybe 30 knots, then vacillates between warm and cold. Then the rain starts with drops, but soon there are sheets of it. It becomes so thick that neither you nor your radar can see through it. It rains maybe an inch a minute! Then the rain eases to a more normal amount for 15 minutes, then quits. Soon it seems as if you were worried about nothing. By midnight the threat seems to be gone."

There are some places in the tropics where the off-season weather usually isn't dangerous. But it can be dangerous in Central America, which is why we advise against off-season travel.

"White sand beaches, towering mountains over quiet harbors, shoreside bars and hopping nightlife — you don't need to head to the Caribbean or Baja to find these things," writes Mike Josselyn of

the San Anselmo-based Ultimate 20 **Uhoo!** "All you have to do is head up to Tahoe. For those with pocket cruisers, Tahoe is a perfect place for a low-budget short vacation. As I was unable to head down to Baja to cruise with my friends, I trailered my Ultimate 20 up to the lake. Although the typically fickle lake winds can rapidly change direction and speed, just a three-hour sail took me to many state parks, lakeside cafes and diners, as well as to the nightlife at Stateline. It's also possible to do a five-day cruise, stopping at a different anchorage each night. While only Emerald Bay has mooring buoys, it's easy to find sheltered bays and coves. And plenty of shoreside amenities can be found at places like Sunnyside Marina, Tahoe City, and Zephyr Cove. The snorkeling at



UHOO!

*Lake Tahoe has many attractions for the economy cruiser with limited time. But tropically warm water, unfortunately, is not one of them.*

Sand Harbor is great — but you need a wetsuit. Hiking up Mt. Tallac from Emerald Bay to touch the snow and returning to the beach for a BBQ is another treat that can't be beat. But beware of low lake levels, because keel boats can be launched at only a few places."

If you're **cruising** this summer, we'd sure love to hear from you. Just email with a note and some high-res photos.

IN SAN DIEGO

# Sun Harbor

Your Green Escape



World's First  
LEED-Certified  
Marina

SLIPS ★ OFFICES ★ LOCKERS

5000 N. Harbor Drive, San Diego, CA 92106

32° 43' 30" N / 117° 13' 31" W

(619) 222-1167 • [www.sun-harbor.com](http://www.sun-harbor.com)

CDI  
Cruising Design, Inc.  
The best value and reliability

- Mainsail and Jib reefing
- The only U.S. patented furling system for Cruising Spinnakers
- Manage all your sails safely from the cockpit!

607.749.4599

[www.sailcdi.com](http://www.sailcdi.com)

[sailcdi@verizon.net](mailto:sailcdi@verizon.net)



Please read before submitting ad

# CLASSIFIEDS

**1. Write your ad.** Describe what you're selling. Indicate category. Don't forget price and contact info. We make final placement determination.

**2. Count the words.** Anything with a space before and after counts as one word. We'll spell-check, abbreviate, edit, as necessary.

**3. Mail your ad** with check, money order, or credit card info; or deliver to our office; or ...

Submit your ad safely online with Visa, MasterCard or AmEx at: [www.latitude38.com](http://www.latitude38.com)

**4. Ad will be posted online,** appear in the next issue of the magazine, and remain online until the following issue is released.

**Latitude 38** 15 Locust Ave, Mill Valley, CA 94941 Questions?: (415) 383-8200, ext 104 • class@latitude38.com

## Personal Ads

1-40 Words: \$40  
41-80 Words: \$65  
81-120 Words: \$90  
Photo \$30

• Personal Advertising Only •  
No business or promo ads except  
Non-Profit, Job Op, Business Op

## Business Ads

\$70 for 40 Words Max

• All promotional advertising •  
1 boat per broker per issue  
No photos or reversals

No extra bold type • Max: 12 pt font  
Artwork subject to editor approval.  
Biz ads will not appear on website.

### 'Trying to Locate' Ads

Searching for lost boats/people: \$10 for 20 words max

### FREE Online Ads

Private party selling boat or gear for under \$1,000 total

All ads will be set to fit **Latitude 38** standard.  
Re-Run Ads: Same price, same deadline.

## DEADLINE

is always the

**18th at 5 pm**

for ad to appear in the next issue.

Due to our short lead time, deadlines are *very strict* and include weekends & holidays.

- No ads without payments
- No billing arrangements
- No ads accepted by phone
- No verification of receipt
- We reserve the right to refuse poor quality photos or illegible ads.

**WHAT'S IN A DEADLINE?** Our Classified Deadline has always been the 18th of the month, and it's still pretty much a brick wall if you want to get your ad into the magazine. But it's not so important anymore when it comes to getting exposure for your ad. With our new system, your ad gets posted to our website within a day or so of submission. Then it appears in the next issue of the magazine. So you're much better off if you submit or renew your ad early in the month. That way your ad begins to work for you immediately. There's no reason to wait for the last minute.

**MAKE OFFERS: 24-FT MELGES.** Hull numbers 15, 14 and 87, for delivery on the West Coast. Pricing starts at \$26,000 US. All are in good condition, ready to race. Fast, easy to trailer. Contact Frank (512) 750-5735 or cabosportsfrank@yahoo.com.



**CAL 20, 1966.** \$1,750. On 4-wheel trailer. Merc 6-hp. Sleeps 4. Roller furling jib, Porta-Potti, fully equipped and in good shape. GPS, VHF included. Dry sailed at Channel Islands Harbor, Oxnard. Call Jeff (818) 889-0898.



**J/24, 1978.** Fort Bragg, CA \$6,000 OBO. In good sailing condition. Recent Halyards, compass, and new winch. Two mains, 100%, 80%, 120%, and two spinnakers, all in fair to good shape. Comes with trailer. (707) 813-7644. jnm@mcn.org.

**22-FT WESTERLY CIRrus,** Morro Bay \$1,776. Trailerable, English twin-bilge keel sloop. Very tough, seaworthy. Fiberglass little oceangoing vessel with a double-axle trailer. Bahamas and Hawaii vet. On trailer. (805) 234-6000 or (928) 753-1375.

**CATALINA 22, 1986.** Petaluma \$4,750. Great shape! 7.5 HP Honda 4 cycle, trailer dry stored 3 sails swing keel, pop top, stove, Porta-Potti, radio/cd, lifelines, swim ladder, nice interior, many extras. Must see! Call (510) 508-2698. cdvolson@prodigy.net.



**22-FT POCKET ROCKET.** \$7,000. Bal-lenger mast and boom. New elliptical rudder. Lots of sails. Radio, depthsounder, autopilot, self-tailing winches, trailer. Fast boat and lots of fun. (408) 245-1387.

**ULTIMATE 20 SPORTBOAT, 2001.** \$21,000. Outstanding condition. Doyle sails in excellent condition. New galvanized trailer w/brakes. Custom shroud adjusters. Carbon Abbott rudder. 2 full top covers. Mast up and down. Zippered jib cover. All safety gear, lifejackets, anchor, rode, etc. Call (415) 543-7333; email: spinnaker.sailing@yahoo.com.

**20-FT ALERION, 1996.** Clearlake, CA. \$16,000. "The best looking girl at the dance." Hull #24. Lightly used in fresh water sailing. Trailer and new electric motor included. Check out the website at: <gallery.me.com/worldaccents#100064> (415) 729-1139. Email: garret.law@sbcglobal.net.

**ULTIMATE 24, 2002.** \$29,950. Hull #2. Custom Sharkskin carbon bottom paint. Still like new. Freshly painted carbon sprit, mast and boom-White LPU. Harken gear throughout. Nav station w/electric panel board. Ridged boomvang-adjustable compressed air spring. Cockpit adjustable headstay (no backstay). Ullman class main, jib & spinnaker. Near new North high-wind main, jib & spinnaker. Hatch spin launch bag. (415) 543-7333; email: spinnaker.sailing@yahoo.com.

**ULTIMATE 24 SPORTBOAT, 2002.** \$29,950. Custom Sharkskin carbon bottom paint. Freshly painted carbon sprit, mast and boom. All Harken gear. Ridged boomvang. Cockpit adjustable headstay (no backstay). Ullman class main, jib & spinnaker. Near new North high-wind main, jib & spinnaker. (415) 543-7333; spinnaker.sailing@yahoo.com.

## 25 TO 28 FEET

**ALBIN VEGA 27, 1974.** Moss Landing, North Harbor. \$15,000. Diesel, new standing rigging, re-wired, jiffy reefing, tabernacle mast, legal head, new upholstery, VHF, GPS, permanent berth. Needs new bottom paint and new owner. (408) 358-1026 or kghemingway@earthlink.net.

## DINGHIES, LIFERAFTS AND ROWBOATS

**8-FT PORTLAND PUDGY, 2008.** Redwood City. \$1,250. Unsinkable, rigid hulled. Serves as a rowboat, motorboat, sailing dinghy, and proactive lifeboat (Motor/sail rig not included). Used only in fresh water and garage stored. Check out manufacturer's website at: <www.portlandpudgy.com> (415) 935-9141 or (650) 804-1818; wvu2@att.net.

## 24 FEET & UNDER

**MOORE 24, 1982.** Richmond Yacht Club. \$10,000. Good condition, includes trailer, new outboard. (510) 418-1630 or algwind@sbcglobal.net.

**Jack D. Scullion**  
Yacht Services  
jdsyachts@att.net  
(510) 919-0001

Rigging  
Electronics  
Troubleshooting  
Electrical Installations  
*We Gladly Install Gear You Provide*

**NEILPRYDE**



**SAILS**

## NOR-CAL COMPASS ADJUSTING

Magneuto™ System Exclusively  
Boat Remains in Berth • Eliminates Deviation  
Authorized Compass Repair • All Major Brands  
**Hal McCormack • Phone/Fax: (415) 892-7177**



## BOAT • LETTERING

alphaboatsue@aol.com • (510) 599-1197 • www.alphaboatgraphics.com

**Creative and durable lettering and artwork for your boat**

**ANTRIM 27, 1996.** Point Richmond. \$40,000. K5, Hull #1. Exciting one-design sport boat. Sails over 15 knots. Carbon mast, new trailer. Barely used Quantum Fusion main and jib, lots of extras. See: <www.u27class.org/> (415) 828-1203 or robdkessel@yahoo.com.



**ALERION EXPRESS 28, 2002.** Bainbridge Island. \$89,500. Classic daysailer/weekender, navy hull, Yanmar diesel, Hoyt jib boom, head, V-berth, full boat cover, sports cover, cockpit cushions, and more. Please visit website: <www.alerion28.blogspot.com/> (206) 780-2660 or (206) 780-2829 or chriswingfield@gmail.com.

**25-FT SANTANA 525, 1980.** Lake Don Pedro. \$3,500/obo. Good condition. New North Sail main and gennaker, new rigging. 24-volt electric motor, solar panels for recharging, no trailer. Fleming Meadow Marina, Slip 25. Call (209) 575-2653 ext. 303 or (209) 471-9968 or email: mb@modestocpas.com.



**27-FT SANTA CRUZ, 1978,** San Pedro \$14,500 negotiable. The interior of this well-maintained sleek racer has been refreshed. Several bags of sails. Great, fast, fun, good-looking boat. Hull #104. 4-hp outboard motor. New tandem axle trailer with disc brakes, ready to roll! More pics online. <wakitu.com/cm/thumbnails.php?album=3> Call (323) 254-7134. Email: wakitu@gmail.com

**27-FT CATALINA, 1978.** Berkeley Marina \$9,000. Beautiful gloss white Lefell mast and boom, standing and running rigging, and North Sails mainsail all new in 2005. 2008 Pineapple 90% jib. Strong Atomic 4. Waterlift muffler. Details at Sailboat listings.com <www.sailboatlistings.com/view/13717> Call (707) 442-7569 home or (707) 362-6749 cell or email: starstrm@suddenlink.net home.

**27-FT O'DAY, 1974.** Berkeley. \$3,000. Hauled 2004, bottom cleaned every 3 months. New running rigging, new wiring, 3 mains, 3 jibs, 2 anchors, radio, inflatable, sleeps 5. Fast, stiff sailer. Berth available at Berkeley Marina with land line. (415) 826-6572 or wswan12001@yahoo.com.

**ERICSON 27, 1973.** Berkeley \$7,500. Good condition. Clean, roomy interior. Westerbeke diesel engine with low hours. New fuel tank. Roller furling, GPS, VHF, dodger, windlass. Bottom paint and survey 02/08, electric head w/holding, Force 10 heater. (510) 780-6475. manukeajason@yahoo.com.

**26-FT INTERNATIONAL FOLKBOAT,** Berkeley Marina \$7,000. Fiberglass, excellent sailer, traditional graceful lines, self-bailing cockpit, sailed to Hawaii and back. No engine, easily sails in and out of Berkeley upwind berth. Less than \$2,000 equips with outboard. Lots of extras. Email: Notions@att.net.

**SANTA CRUZ 27, 1976.** Point Richmond \$10,000. Optimized for shorthanded offshore racing but proven winner in both OYRA and one design. Ready to race. Serviceable double-axle trailer, no outboard, one-design main and other extras available at additional cost. (650) 349-5590. <www.worthyperformance.com/andiamo/> Email contact is: mark@worthyperformance.com.



**EXPRESS 27, 1985.** Richmond Yacht Club. \$19,000. *Salty Hotel* is a superb example of this highly successful racer/cruiser from Carl Schumacher and Alsborg Bros. Great boat for one-design racing including offshore. Always dry sailed from a trailer, in great condition, and with many extras. Recent hull survey available to serious parties. Detailed flyer: <http://www.mpw-llc.com/saltyhotel/> Photos: <http://gallery.me.com/wippich#100017> (650) 868-4602. Email: mark@mpw-llc.com.

**MACGREGOR 26, 2006.** Loch Lomond Marina. \$22,900. Very clean boat. Excellent conditions. Completely equipped. Blue hull, 50HP Evinrude E-Tec, shore power, second battery, GPS/VHS, bottom paint and much more. Leaving for Europe so have to sell. (650) 222-8748.

**CATALINA 28, 1990.** Clipper Marina, Sausalito. \$24,900. Excellent condition, well-maintained. Wing keel; tall rig; Split backstay; 18 hp Universal M3-20 diesel; 36" wheel steering; roller furling jib; dodger; Autohelm; dinghy & OB motor; All lines led aft for easy handling. <www.portlight.com/yamas.html> (415) 435-5059.



**25-FT CATALINA, 1983.** Stockton Sailing Club. \$5,500. Superbly kept and equipped boat, 9.9HP Evinrude, swing keel, roller furling jib. Completely new upholstery and carpet, all lines led aft, lazy jack, knot meter, depth sounder, GPS, compass, two batteries and charger, VHF radio, stereo, head, holding tank, water tank, galley, autopilot and much more. All equipment goes with it from life jackets to microwave! One owner for 15 years. (916) 359-6845. jangwynn@sbcglobal.net.

**RANGER 26, 1974.** Channel Islands Harbor. \$4,900 obo. Excellent cruiser/racer, very good condition. Full race gear, 7 North sails, spin gear, reaching strut, almost new standing and running rigging, faired bottom, new paint 2008, spare boom and tiller. New bronze thru-hull valves. Nissan 8 hp outboard, two anchors, chain and rode, lots of extra equipment. Very clean interior, upgraded cushions. Has won many races plus extensive cruising in Channel Islands and Catalina areas. For complete details email: bmckenna3@gmail.com.



**28-FT PEARSON, 1975.** Alameda. \$7,500. Great Bay or coastal cruiser in nice condition. Since 2006: new standing, running rigging, new Harken roller furler, rebuilt Atomic 4, new prop shaft and prop. Brand new Rooster main and 115% furling jib. Lectrasan head, tiller/pilot. Call (510) 593-8697 or ssnick@gmail.com.



**27-FT HUNTER, 1983.** Stockton Sailing Club. \$9,500. One owner, well maintained; LOA 27'2"; LWL 22'; Beam 9'3"; Draft 4'3"; Displacement 7,000 lbs; ballast 3,000 lbs; cruising sails: main, jibs 110 & 85, Profurl roller furling; Yanmar 1GM inboard diesel, Edson wheel steering; all lines led aft; Combi Total Data Center, VHF; Balmar 80 amp generator, two new 105 amp-hour batteries, Pro-mite 20-amp charger; two epoxy barrier coats 2005; six opening ports, two overhead hatches; fuel 12 gal, holding tank 15 gal, water 30 gal. (510) 796-8424 or hunter27-4sail@comcast.net.

## 29 TO 31 FEET

**J/30, 1981.** Santa Cruz. Best offer. Retired racer. Seaworthy but needs work. Possible Santa Cruz Harbor sublet. (831) 462-2338 or miltgold2000@yahoo.com.



**CAPE GEORGE 31 CUTTER, 1992.** Port Townsend, WA. This CG is one of the finest examples of a yard-completed Cape George 31 in existence. Launched in 1992, carefully maintained, well equipped for extended cruising. Interior layout features laminated Port Orford cedar beams, trim with teak cabinets. Double berth forward, enclosed head with shower, settee-berths amidships, overhead skylight. Aft galley to starboard, nav station to port. Cockpit has two large cockpit lockers, 1 propane locker and 1 lazarette locker. New engine, radar, Trinka dinghy, running backstays, downwind pole, windlass, AGM batteries, Force 10 stove, BBQ, boom gallows, windvane, SSB, VHF, new thru-hulls/seacocks, etc. See at: <www.capegeorgecutters.com/brokerage/infinity.html> (360) 385-3412 or cgmw@olympus.net.

**29-FT ALBIN BALLAD, 1973.** Alameda. \$8,000. Previously cruised sloop, tiller steering, keel stepped mast, skag hung rudder, fin keel. Numerous sails, radar speed-o, VHF, Yanmar 18hp engine. Hydrovane self steering. Autohelm autopilot. Needs some work. (510) 407-2716 or (510) 530-3033. rainethree@aol.com



**31-FT WYLIE, MOONSHADOW.** \$18,000/obo. One of Tom Wylie's best custom-designed yachts for SF Bay and ocean racing. A winner, remains competitive today. Yanmar diesel, 9 Barient winches, stainless rod rigging, Barient backstay adjuster, Quick Vang boomvang, large sail inventory, Martex prop. Sleeps 6. Hauled 10/08, new bottom paint. Excellent condition. Race ready. (415) 435-1006 or (415) 377-6688.

**30-FT BIRD, 1936.** Brisbane, CA. \$5,000. Bird boat. Needs work. Recent refastening, new transom, in water. Call (510) 260-1743 or (415) 518-3914.

Yacht Repair  
Design / Consulting

Custom Interiors  
Exterior Joinery



### STEVE'S MARINE WOODWORK

60 C Libertyship Way, Sausalito  
jonessail@aol.com • (415) 332-2500

### VOLPAR, Inc.

(408) 986-0848 • (800) 258-4545

Parts / Service • Penta Only

10am-7pm PST every day including Sat-Sun  
email: Volpar@Volpar.com

# VOLVO PENTA



### EAST BAY SAIL & COVER CLEANING

mildew, rust, grunge

(510) 523-9011



### MARINE SURVEYS by Captain Alan Hugenot

Naval Architect • Yacht Delivery Skipper

Accredited Marine Surveyor (SAMS)

Bay or Delta • No Travel Charges • MC / VISA / AmEx  
alan@captainhugenot.com • (415) 531-6172



# OUR METALWORK IS A "STEEL"!

## BEST PRICES ON STAINLESS REPAIRS & CRUISING UPGRADES!

Railings  
Pulpits

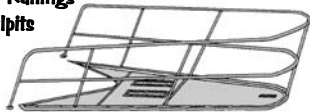

Integrated Bow Rollers



Basic Arch  
as low as  
**\$3,000!**

**Alameda Prop & Machine**  
at the Grand Marina Marine Center  
(510) 522-7899 (800) 774-7899

**CATALINA 30, 1990.** San Francisco Marina. \$37,000. Excellent condition. New Harken and standing rigging. Press. hot-cold water. Wheel steering. Univ. M25XP. New house batteries. Raymarine ST360 depth, speed. Autohelm ST4000. (916) 803-6410 or gkmunoz@gmail.com.

**29-FT FARALLON, 1976.** Berkeley. \$6,000. Ruggedly built for blue water; needs some work. Volvo MD6B 210 hours but very well maintained. (510) 655-4740 or farallon29@hotmail.com.

**30-FT TARTAN, 1978.** Alameda. \$15,000. Well maintained, very clean, classic Sparkman & Stephens design with reliable Atomic 4 engine, many extras. Dodger, furler, BBQ, new head, stainless fuel tank and new prop. (510) 864-9880; email: ejwoollett@aol.com.

### 32 TO 35 FEET

**HUNTER VISION 34, 1984.** Newport. \$29,000. Beautifully maintained boat, 20-hp Yanmar diesel, autopilot, VHF, compass, roller furling jib, cockpit table, new cushions, new marine head, hot shower, plow and Danforth anchors, Avon dinghy. (626) 335-7047 or (626) 347-5349 or nagee20408@aol.com.

**CORONADO 34, 1969.** Loch Lomond. \$16,800. Cruiser, Albin 21 diesel, wheel steering, full keel, furler, 3 newer sails, depthfinder, knotmeter, VHF, clean interior, 6'2" headroom, deck vinyl pads, rail BBQ, 2 new batteries, dinghy on davits. Good liveaboard. (510) 393-7700.

**35-FT J/105, AQUAVIT** is for sale, \$92,500. Fastest 105 on the Bay. Season champion 2007. Number 103 (pre-SCRIMP). Excellent sail inventory. Professionally faired bottom. A steal for \$92,500. Willing to help new owner get up to speed. (415) 302-8926.



**32-FT COLUMBIA 5.5 METER, 1960.** SF Marina. \$7,000. Located in East Harbor, SF Marina. Slip transferrable upon harbor-master approval. Has current sails (main, jib, and spinnaker), refinished/repainted interior, new rigging, new cleats, new adjustments, new bottom (super fair carbon anti-foul), new lines, remotely adjustable jib leads, topsides polished, wire hoisting slings, and a new cover. (415) 244-5422 or cmtozzi@sbcglobal.net.



**34-FT BENETEAU 10R, 2007.** Long Beach. \$135,000. Yanmar 20 hp, Harken furler, main, jib, spinnaker, dodger, canvas, performance and comfort pacs, liferaft storage, multiple NKE electronics and repeaters, loaded, ready to go. Pictures: <www.quivercharters.com> (310) 809-2263 or ddavies@usc.edu.



**HALLBERG-RASSY 35, 1972.** Moss Landing, CA. \$55,000. This is a nice center-cockpit bluewater cruiser. 30k in the last few years. Rebuilt Volvo MD30A. New Ullman sails with Furlux on jib. New rigging. Comnav autopilot, Raymarine plotter, radar, Interphase Outlook and more. (831) 595-2467 or olinjordan@yahoo.com.

**35-FT J/105, 1992.** South Beach Harbor, San Francisco. \$57,500. Tiller boat, La Pavoni. Aggressively priced. Fast (Pre-SCRIMP) boat. Needs some maintenance and priced accordingly. (408) 569-2480 or edoel2@gmail.com.



**35-FT J/BOATS J/109, 2004.** Sausalito. \$185,000. Fast, fun, mint condition racer/cruiser single-hand or with crew. 1st 2008 J/109 Division, 1st 2009 J-Fest Division, 3rd PHRF (72 rating). Quantum Kevlar racing & Dacron cruising sails (2 mains, 2 jibs), 2 asymmetric spinnakers, new rigging, Spectra lines. B&G instruments, VHF radio, GPS, Yanmar diesel, 29 hp, excellent condition. Doubles as performance cruiser with roller furling, all rigging led aft, sleeps 6+ with full galley, head, shower, hot/cold water, fridge. Ready to race one-design, Pac Cup, PHRF or cruise oceans SF Bay and Delta in comfort, style and performance. Must sell. (415) 717-3664 or ahoys@earthlink.net.



**Society of Accredited  
Marine Surveyors®**

**Serving Northern California**

**Jesse Brody, AMS®**

415.342.0757

jesse@baymarinesurvey.com

**Francoise Ramsay, AMS®**

415.497.7409

framsay@comcast.net

**Tom List, AMS®**

415.332.5478

listmarine@yahoo.com

**Randell Sharpe, AMS®**

877.337.0706

rsharpe@sharpesurveying.com

**Jack Mackinnon, AMS®/SMS**

510.276.4351

surveyjack@aol.com

**Rick Whiting, SA**

415.740.2924

captain\_rick@sbcglobal.net

**Chris Nye, SA®**

925.285.9704

nyesurveying@gmail.com



**Fred Andersen Boat & Woodworks**

**Repair,  
Restoration &  
New Construction**  
(510) 522-2705

#### SMALL AD, SMALL PRICES • RIGGING ONLY

Standing and running rigging, life lines, furling gear, winches, line, windlasses, travelers, wire and terminals, blocks, vangs, and much more.

~ ~ ~ Problem solving and discount mail order are our specialties ~ ~ ~

[www.riggingonly.com](http://www.riggingonly.com) • (508) 992-0434 • email: [sail@riggingonly.com](mailto:sail@riggingonly.com)

**32-FT WESTSAIL, 1973.** Pier 39 slip C-11. \$32,000. Factory boat. Documented. Rare rectangular main ports. Hull, spars, sails, engine all sound. Bronze windlass. Achilles. Pictures and detailed description including all known faults on request. Possible boat/slip combo deal. Come view. Low as-is price will rise as refit progresses later in the summer. (707) 494-8931 or dweitzeil@hotmail.com.

**34-FT ERICSON, 1978.** Redondo Beach, CA. \$19,999. Fully loaded with radar, GPS, windpoint/windspeed, autopilot, dual compasses, ICOM VHF radio, and more. Rebuilt engine, new bottom paint, varnish and Awlgrip on the decks. 7 sails, dodger, and bimini. This boat sails fast. (310) 968-3070 or (310) 822-0669. Email: timb@cyayachts.com.



**32-FT BENETEAU FIRST 32S5, 1989.** Sausalito. \$48,900. The First 32s5 is an amazing combination of race-level performance and luxurious Euro-styled elegance. The exterior is a sleek head-turner and the interior's warm mahogany trimmed with brushed aluminum and marble is extraordinary! Everything about the 32s5 is performance oriented; from the deep keel to the tunable mast and deck hardware. But she's also a beautifully easy boat to sail, elegant and comfortable at anchor. Upgrades include a HUGE "smart" battery system and comfort features such as custom teak cockpit table and closed cell foam cushions for on-hook convenience and comfort. Meticulously maintained with all service records. Looks and performs years younger than actual age. (415) 332-5209. Email for pictures and details: JohnWChandler@sbcglobal.net.



**33-FT CUSTOM CUTTER ANNIE, 1981.** Port Townsend, WA. \$108,000. Custom built, full keel, fiberglass hull with Airex core. Wood house, decks and interior, seven Hasse & Petrich sails, Volvo diesel, Autohelm, pressure water, ElectraSan, propane galley stove. A robust and superbly constructed cruising yacht. Shows as new. priatt.annie@gmail.com.

**PEARSON 32 RACER/CRUISER, 1979.** Alameda, CA. \$22,500 or reasonable offer. Fast, easily singlehanded sloop. Featured in August 2007 'Practical Sailor'. 1,250 hours on original M-15 Universal diesel. Gear, vintage 1995: Autopilot, digital depthfinder and gauge, genacker, Harken furler, Navtek backstay adjuster, Hall Spars Quik Vang, Furuno radar, 25w marine radio. New: 19-gallon aluminum fuel tank and electric fuel pump, 2002. 2 batteries 2006. Documentation: All original manuals, '95 survey, maintenance, diving, haul records since my 1995 purchase. (510) 525-2754.

**35-FT ERICSON, 1975.** Emeryville. \$29,500 obo. This boat is one of the best Ericsons on the Bay or out the Gate. Come sail and check it out! Well equipped, well maintained, many upgrades. Priced to sell. (925) 284-4461 or (925) 708-4084.

**34-FT CAL, 1977.** Alameda. \$25,500. Very nice condition & great price! All of the gear you would expect for a Baja vet and much of it newer. Great sailing boat, strong running Westerbeke 30HP Diesel. Call Jay for more info and photos. (209) 617-1384. Email: jay.sousa@sbcglobal.net.

**CAL 34 MK III, 1977.** Emeryville. \$26,000. New bottom, diesel mounts, new dripless stuffing box, wheel steering, good sails + ProFurl, 55G SS fuel, holding tank, lots more. Solid Lapworth design, easy to sail on Bay or cruise. <home.comcast.net/~lewisswan1> (510) 962-6122. Email: sailingman40@gmail.com.

**32-FT WESTSAIL, 1976.** Sausalito, CA. \$60,000. Cared for cruising boat with the cruising gear and lots of upgrade. Please call for full details: (707) 874-0345.

**34-FT COLUMBIA, 1971.** Point Roberts, WA. \$29,900. 2005 refit, 7' headroom, head forward design with pullman berth, sloop/cutter rig, lazy jacks, roller furling, Yanmar diesel, power windlass, wheel steering, autopilot, windvane, radar, dodger, dinghy, propane galley, hot water. Can e-mail photos. columbia1971@gmail.com.

**ERICSON 34, 1981.** South Lake Tahoe. \$30,000. In lake 10 years. Equipped for ocean sailing with Autohelm, radar, heat, refrigeration, battery charger, self-tailing winches, new Harken jib roller furler, spinnaker, Universal diesel, teak cockpit, interior, great condition. Detailed specs/pictures. (530) 906-7883. Email: MarianneBennett@charter.net.

**34-FT SAN JUAN, 1984.** \$39,000. Fast comfortable, blue water cruiser, excellent condition. 6' headroom, galley, sleeps six, rod rigging. Roller furling headsail, 150% genoa, main, working jib, in good condition. 3GMD Yanmar, Achilles dinghy, large bimini. Price reduced. Call (510) 420-8956; nino@access-print.com.

**34-FT ERICSON, 1987.** Berkeley. \$49,500/ Price reduced. Cruiser and fast sailboat in excellent condition. Roller furling jib, spinnaker, autopilot, chartplotter, dodger, beautiful interior, refrigeration, extensive DC/AGM upgrade 2008. Universal diesel, much more. Berkeley slip. Detailed specs and pictures: <www.ericson34.info> (510) 717-5693. jdeboerf@yahoo.com.

**32-FT ERICSON, 1974.** Redwood City. \$18,500. Beta Marine, 220 hours. Alpha3000 autopilot, Horizon depth and knotmeter. Good main with 3 reefs, good storm jib, new UK tapedrive 100 and 125% Ballenger boom, Schaefer roller furling, Harken 2-speed self-tailing winches, mast-top strobe, dodger, singlehanded TransPac vet. (650) 575-2466. Email: PatTuna22@aol.com.



**COLUMBIA 34 MK II CUTTER, 1972.** San Diego, Shelter Island. \$14,500. Beautiful Columbia, roomy, classic. Hull and bottom/deck paint recent. Solid and ready for your gear. Palmer runs great, main/jib, simple, everything works. Sail away or cruise here. She could be ready for the 2009 Baja Ha-Ha. (619) 865-2963. Email: ssoenk@yahoo.com.

**32-FT COLUMBIA, 5.5 METER, 1965** with slip at Berkeley Marina. \$5,000. New traveler and main sheet. Custom teak/holly hatch covers. Main, spinnaker, 150 and working jib. Honda 7.5 hp four-stroke outboard. (925) 366-0089.



**33-FT ALAJUELA, 1979.** Ventura, CA. \$50,000. Bigger than most 35s. Excellent offshore cruiser. Repowered with Perkins Perama M35. Excellent sail inventory. (714) 732-9882; Jablonce@bp.com.

## 36 TO 39 FEET

**RAFIKI 37. \$49,500.** Double ender, good liveaboard. Cutter rig, radar, updated electrical, instruments, plumbing, running rigging, fuel tanks, LPU and cushions. Sound engine. Tom (510) 799-1712.

**JEANNEAU 36, 1997.** Price reduced: \$89,000. Very well maintained. Electric anchor windlass, dodger, refrigerator/freezer, GPS, chartplotter, autopilot, CD player, VHF, B&G instruments, depth/knot/wind, dinghy with 2-hp Johnson. To view call Roy or Brian. (510) 523-4081 or (209) 722-2068 or coolswick@aol.com.

**CATALINA 36 MK II, 1996.** \$93,000/obo. Universal diesel, new StackPack, dodger and bimini, roller furling/3 headsails. New bottom, very well equipped, meticulously maintained. Interior like new including stereo and TV. Must see. No disappointments. (925) 228-2852.

**C&C 36, 1979.** Brisbane. \$33,999.99. Canadian-built racer/cruiser. Atomic 4, Schaefer roller furling, main, jib, wheel steering, self-tailing winches, etc. Call if you'd like to make an offer. You won't offend me. Must sell. See: <http://sfbay.craigslist.org/pen/boa/1246843595.html> (801) 816-1110 or (801) 403-6304 or email: mark.visina@am.sony.com.



**MORGAN 38 CC, 1993.** San Diego, CA. \$80,000. Waterfront living at its best. There is no other option out there that allows oceanfront property at this type of price in San Diego. Morgan is an excellent sailboat and there are 5 currently for sale across the country. The prices range from 93k to 130k. This boat was listed for 110k and is now listed for 80k, well below the market rate. Additionally this boat is located at Humphrey's by the Bay <www.humphreysconcerts.com/>, which has live concerts from May - October for your viewing, listening and entertainment pleasure. Take advantage of this for sale by owner/ no broker offer today. (619) 243-6269 or jdarrochdesign@yahoo.com.

**COLUMBIA 36, 1968.** Port Hadlock Marina, WA. \$35,000. This vintage sailboat has too many upgrades to list. Please email or call for more info, specs and pictures. The most diesel boat for the money on the West Coast. (626) 483-0150 or littleah30@yahoo.com.

**36-FT SABRE, 1998.** Berkeley. \$155,000. Blue hulled with newer main, rigging, topsides, Autohelm and extras. Shallow draft keel perfect for getting to the hard to reach places. She has been a blast to sail, but the kids are keeping me too busy to get on the water enough. (925) 766-2205. dan@deltaexcavating.net.



### August Enterprises

## Marine Surveying and Consulting

Serving the Bay Area since 1995

510-889-8850

## WOODRUM MARINE

Specializing in custom interior cabinetry, tables, cabinets, countertops, cabinsoles. For power or sail.

### CARPENTRY

Mobile cabinet shop  
Contact Lon Woodrum at:

415-420-5970

www.woodrummarine.com



### STARBOARD YACHT DELIVERIES

Over 50,000 sea miles • Pacific, Caribbean, Atlantic  
USCG Master 100 GT STCW • Power & Sail

Rick Whiting • (415) 740-2924 • captain\_rick@sbcglobal.net

### VOLVO PENTA

Specialist Dealer Since 1980

ESKELUND MARINE • (510) 523-7670

1913 Clement Ave • Alameda Marina • Bldg 13 at Pier 2



## Custom Canvas & Interiors

Visit us  
at our new  
location!



The Gianola Family has been designing and fabricating custom canvas and interiors since 1969. Gianola Canvas Products offers you the best in quality, more choices, and personal service.



265-B Gate 5 Road  
Sausalito, CA 94965  
(415) 332-3339  
[www.gianolacanvas.com](http://www.gianolacanvas.com)

**HONDA**  
**MARINE**  
IT'S ALL ABOUT POWER.

**caribe**  
INFLATABLES

**Aquapro**  
INFLATABLES



**TOHATSU**  
outboards

**Achilles**

We've been **THE Bay Area** authority for  
inflatables and outboards for more than 35 years.

Call us today for quotes.

**Voyager Marine**

1296 State St.  
P.O. Box 246, Alviso, CA 95002-0246  
(408) 263-7633 • (800) 700-7633  
Open Tuesday thru Saturday



**38-FT TARTAN 3800, 1995.** Marina Village, Alameda. \$140,000. Classic beauty, well maintained. New mainsail. Raymarine instruments and radar. MaxProp, three blade. Loves ocean sailing. Call (925) 330-1378. [mward@annward.com](mailto:mward@annward.com).

**36-FT BENETEAU FIRST 36.7, 2003.** San Pedro, CA. \$108,000. Bristol condition inside and out. Two sets of sails, cruising and Pentax racing, all in excellent condition. Boat priced below market for fast sale. (213) 280-9764; [charles\\_curnutt@ahm.honda.com](mailto:charles_curnutt@ahm.honda.com).

**36-FT PEARSON 365 CUTTER, 1982.** San Rafael /Loch Lomond Marina. \$35,000 OBO. Good solid boat in good condition. All records and manuals. Lots of equipment. Has new full batten main with Dutchman system, 100% jib with ProFurl roller furling in good cond., staysail older but in good condition, cruising spinnaker with sock, 44 HP diesel. Radar, GPS, VHF, new Achilles inflatable with 9.9 Nissan OB. (707) 578-2661 or (707) 291-1578. [scupperjim@comcast.net](mailto:scupperjim@comcast.net).

**36-FT ISLANDER, 1980.** Berkeley Marina. \$34,000. Low hour Yanmar 38 hp diesel, roller furling, cruising spinnaker, autopilot, radar, chartplotter, VHF, SSB, elect. windlass, bow roller, 2 anchors, hot/cold pressure water, high output alternator, refrigeration. Baja vet, good solid boat goes anywhere. (510) 644-1217 or (510) 684-7388. [michaelgray@comcast.net](mailto:michaelgray@comcast.net).

**CAL 39, 1978.** Alameda. \$65,000. 50 hp Yanmar repower 300 hrs, C-80 Chart plotter/Radar/fishfinder, ProFurl w/100% & 150 jibs. Full dodger, Maxwell 2500 windlass. Full details see website. [www.ideasinmotion.com/cal39](http://www.ideasinmotion.com/cal39) Call (510) 864-0237; [borelimgf@earthlink.net](mailto:borelimgf@earthlink.net).

**36-FT ISLANDER, 1983.** \$49,900. *Silver Shadow*. Boat in excellent condition with many extras including new Doyle "Stack Pac" main and roller furling jib, cruising gennaker, Pathfinder diesel, backstay gimballed Furuno radar, wind indicator, hard dodger/full cockpit canvas. SSB, CNG, & H&C pressure water system. All lines led aft through the dodger, 4-6 volt house batteries and 1-12 volt starter. Large, leather covered wheel, upgraded bronze ports and standing rigging. Well maintained boat with many extras. Call Al (209) 957-3361. <http://www.stocktonsc.org/silvershadow>

**36-FT ISLANDER, 1975.** Sausalito. \$30,000. New bottom 04, new standing rigging 04, new engine 06 (approx. 15 hrs), Max Prop, propane, pressure water, masthead LED tri, Raymarine instruments & autopilot, other upgrades, topsides need TLC. (707) 575-3350 or (707) 291-2020. [guydean@sonic.net](mailto:guydean@sonic.net).

**FREYA 39, 1977.** Antioch City Marina. \$49,500. Serious, quick passagemaker, comfortable cruiser. Sydney-Hobart winning design, one owner. Yanmar 3 cyl, 36 hp, 2,184 hours. Aries vane gear, two autopilots, Avon, Raymarine fathometer, GPS, SSB ready. Sloop, cutter possible. (925) 522-1353; [crowellam@hotmail.com](mailto:crowellam@hotmail.com).

**39-FT BENETEAU 393, 2002.** Sausalito. \$168,000. Well equipped racer/cruiser. 2-cabin 2-head model. Full batten main, 135, 105, spinnaker, pole. Diesel, autoprop. GPS, radar, chart, wind, autopilot. Windlass. Cherry interior, ultra-leather. Sale or partnership. [marigotgroup.com/strider](http://marigotgroup.com/strider) (415) 332-4401 or (415) 331-4900. Email: [393@marigotgroup.com](mailto:393@marigotgroup.com).

**ISLANDER FREEPORT 36, 1979.** Blaine, WA. \$74,000. B model deck salon in outstanding condition, with Tempurpedic mattress in pullman berth, Espar heat, Adler Barber refrigeration, Furuno Radar, Perkins engine, packless gland, wheelpilot, solar panels, Schaefer furler, lazy jacks, 80 fuel, 115 water, 4 anchors, 1 chain & 2 nylon rodes, 5 sails, 2 props, complete Sunbrella boat cover, many spares. 6'7" headroom with large berth and spacious head with shower. Beautiful varnished interior. Excellent cruiser/live-aboard. (360) 371-7577.

**KETTENBURG 38, 1956.** Berkeley/Wilmington. 3 K-38 classics. Each in various stages of renovation. 2 in the water. Please see details. [www.saik38.com](http://www.saik38.com) (916) 847-9064; email: [steve@paradgmpilgrim.com](mailto:steve@paradgmpilgrim.com).



**36-FT PEARSON 365 KETCH, 1977.** Alameda. \$55,000/obo. Beautiful live-aboard. 40-hp Westerbeke diesel. 3 new sails. 2005: Standing rigging, refrigeration, entertainment and electronic systems. Inflatable rigid bottom. Much more. (925) 457-4957; [sailonchap@yahoo.com](mailto:sailonchap@yahoo.com).

### OFFSHORE PASSAGEMAKING INSTRUCTION IN THE SOUTH PACIFIC

John & Amanda Neal are dedicated to providing hands-on, documented instruction aboard their Hallberg-Rassy 46 *Mahina Tiare III*, drawing on their combined 502,000 miles and 66 years of experience.

[www.mahina.com](http://www.mahina.com) • (360) 378-6131



**Custom Sewing**

[www.customsewing4you.com](http://www.customsewing4you.com)

Specializing in:  
Indoor/Outdoor Fabrics  
Marine Cushions & Accessories  
**(415) 305-8485**



**38-FT HANS CHRISTIAN, 1987.** Berkeley, CA. \$162,800. Hans Christian 38T Telstar. Traditional, well-equipped, classic, blue-water cruiser; cutter w/cut-away keel and skeg; loves the SF Bay wind; desirable, upwind slip available in Berkeley; excellent condition w/lots of extras; email for more information and photos: sv.mahayana@gmail.com.

**36-FT CATALINA, 1986.** \$52,000. Radar, below deck autopilot, electric windlass, 45# anchor and all chain, refrigeration, propane oven/stove/BBQ, high output alternator, inverter, dodger, bimini and more. (510) 847-5469.

## 40 TO 50 FEET

**CATALINA 42, 1992.** Alameda. \$127,000. Fully-equipped coastal and Hawaii veteran. New rig, ICOM 802, watermaker, asymmetrical. Excellent condition. See in person to appreciate. (831) 431-0229 or krkrp333@netscape.net.



**SPARKMAN & STEPHENS 45** Seafarer yawl. San Francisco. Around \$96,000. Yacht *Soltura*. Built in Holland of solid fiberglass. Sea-kindly and easily handled by two people. The amazing thing about this classic boat is you can't walk away without taking another look. Contact Jerry (415) 435-3513 or gsrusey@yahoo.com.

**40-FT CUTTER, 1996.** Pt Orchard, WA. \$59,000. Dix Hout Bay 40 steel cutter, built in South Africa. New electrical system, turtle, bowsprit, thruhulls, clamps, hoses, Ford-Lehman 59-hp, new exhaust system, sleeps 5 in two cabins, must sell. Email: jabba7tn@hotmail.com.

**EXPLORER 45, 1978.** San Rafael, CA. \$109,000. Beautiful, lovingly maintained, center cockpit sloop/cutter. Constant upgrades past 15 years. Good performer, bright interior with 2 staterooms/heads. Yanmar 62 hp, LPU, radar. Haul and survey 2008. (415) 265-4418 or email: david@winchmate.com.



**PETERSON 40 TWO-TONNER, 1980.** San Diego, CA. \$58,000/obo. This performance racer/cruiser sailed from San Diego to France in 2005 where she was totally refit: new Yanmar engine, hull/deck/mast paint job, bottom fairing, new head, rigging verification, new MaxProp, etc. After several regattas in France, and months cruising the Caribbean, she was sailed back to San Diego where upgrades continued: New refrigeration, new water heater, bottom job/deck paint, March 2009. Race in SoCal (PHRF 69) then cruise the islands in style. (619) 467-6369 or bruno.bomati@gmail.com.



**44-FT TARTAN 4400, 2004.** \$475,000. Hull #1 of Tartan's newest deck salon. Electric winches, Vacuflush heads, full batten main, roller genoa, cruising spinnaker. Espar central heat, bow thruster. Kato davits, Caribe inflatable. Only 170 hours on diesel engine. New condition. (530) 318-0730 or amjohn@sbcglobal.net.

**SAMSON 40 CUTTER, 1980.** Point Richmond. \$29,500. Great for SF Bay. Traditional wood interior, newer sails and rigging, roller furling, autopilot, Dutchman flaking, refrigeration, shower. Double bunk and two pilot berths. Reliable Volvo diesel. Recent Mexico cruise. See: <www.svpatriarch.com> (707) 961-2080 or email: rich@svpatriarch.com.



**45-FT BENETEAU 45F5, 1991.** Ventura, CA. \$125,000. Racer/cruiser, PHRF-63, with 3 cabins, 2 heads, beautiful wood interior. Price lowered for quick sale. Recent upgrades: New MaxProp 2008, fridge, inverter/charger, anchor, windlass. (559) 696-9653 or (559) 261-9295 or rkrause@rjk-law.com.

**50-FT FD-12, 1981.** Guaymas, Mexico. Wanna go cruising but short on experience or lack the right boat? Our unsinkable 50ft pilothouse FD-12 cutter may be the answer. She's an Alaska, Mexico, & SoPac vet w/3 separate staterooms, 2 heads, superb galley, fully-equipped and ready to go. And Mexico's Pacific Coast and Sea of Cortez are convenient to US and a great place to live aboard and build experience. Sellers willing to provide several weeks of onboard training. Pricing, pics & details at <www.svdaydreamer.com> (928) 848-9705.



**42-FT TAYANA VANCOUVER** center cockpit, 1987. \$149,900. Beautifully maintained, proven safe passagemaker, upgraded comfortable interior, island master bed, electric toilet, separate shower. Watermaker, Max Prop, 3 furling sails, solar panels, wind generator, new batteries, windvane, many upgrades and spares. San Carlos. (520) 803-0240; pacificcruising.blogspot.com.



**41-FT ISLANDER FREEPORT, 1976.** Emeryville, CA. \$35,000. Great boat. Good price. (415) 717-1823 or (978) 356-4268; sbahia@earthlink.net.

**42-FT CATALINA, 1990.** South Beach Harbor, San Francisco, CA. \$112,000. Great condition. New dodger, radar, dinghy, chartplotter, autopilot, etc. Extensive upgrades. Full specs available. Thomas. <http://leluya.blogspot.com> Call (650) 298-9043.

**HUNTER LEGEND 40, 1986.** La Paz, Mexico. \$76,000. Multiple upgrades since 2006 include: radar, chart plotter, SSB, refrigeration, propane conversion, stack pack, solar, and more. Cruising Mexico past two seasons and ready to go again. Email or phone for details and pictures. Call (530) 957-2810; Email: ghimes@mindspring.com.



**FORMOSA 41 KETCH, 1978.** Rio Dulce, Guatemala. \$52,500. Classy boat with excellent cruising inventory. Fiberglass hull, hardwood and fiberglass topsides, aluminum masts. Perkins 4-108 rebuilt 2005. Radar, wind and solar power, hydraulic steering, new fridge 2008. Two single, two double berths. Much more. Moored in fresh water, easy sail to Belize. See: <www.tombuttsmontana.com/dragonlady.html> (406) 431-9582; windseeker10@rocketmail.com.



**45-FT BENETEAU 45F5, 1991.** Ventura, CA. \$125,000. Racer/cruiser, PHRF-63, with 3 cabins, 2 heads, beautiful wood interior. Price lowered for quick sale. Recent upgrades: New MaxProp 2008, fridge, inverter/charger, anchor, windlass. (559) 696-9653 or (559) 261-9295; rkrause@rjk-law.com.

**42-FT VALIANT.** \$295,000. Never used. Never in salt water. Quantum sails, ProFurl on jib, autopilot, microwave, Westerbeke diesel. Boat is as new, location Valiant factory in Texas. Contact Dick May. (480) 513-7136; boatseller@aol.com.



**41-FT X-YACHT, 2001** Pt. Richmond. \$199,000. Built, looks and sails like a Swan; super strong, beautiful and fast-PHRF 60. Disp:16,314 lbs. bal:7,716 lbs. draft:6'9" Loaded boat show purchase, Never chartered, raced or cruised, near Bristol. (775) 233-1803; email: billydd@charter.net.



### MULTIHULL DELIVERIES

30+ years & 150,000 miles on multihulls • Safe, swift, dependable worldwide deliveries by USCG licensed ASA instructor Capt. Ralph Drahos  
**(831) 334-6028 • Owners welcome**

Learn multihull sailing and your boat's systems with a professional

### KNOWLEDGE = CONFIDENCE

Create a customized engineering manual for your boat. Spend a day with a licensed marine professional developing diagrams, parts lists and more made especially for your boat.

Call Tom • (510) 407-7369

### N.E. MARINE TITLE

Coast Guard documentation • Title/lien searches • Transfers • Mortgage filing • Escrow services

Local closing facility for brokers or private transactions

30 years experience of doing it right the first time

**1150 Ballena Blvd, Alameda, CA • (510) 521-4925**

### COMPLETE MARINE WOODWORK

Design / Restoration • Expert European Craftsmanship • Interior / Exterior

Repairs / Maintenance • Marine Windows & Frame Replacement

Wood & Dry Rot Repairs • Varnish Work • Marine Painting

References Available • Reasonable Rates • Call (415) 331-6718



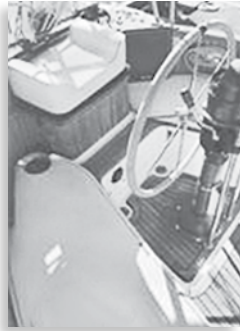

## Save Your Aft!

Using one of our 1400+ patterns or your own pattern, let our craftsmen create a comfortable, durable, and stylish set of all-weather cushions for your cockpit. Find your custom, closed cell foam cushions at [www.bottomsiders.com](http://www.bottomsiders.com)!

### BottomSiders

BottomSiders  
2305 Bay Avenue  
Hoquiam, WA 98550

Call Toll Free: (800) 438-0633  
[cushions@bottomsiders.com](mailto:cushions@bottomsiders.com)  
Fax: 360-533-4474

HAWAII

## LONG TERM DRY STORAGE

*Clear Customs at our dock*

GENTRY'S  
**KONA MARINA**  
HONOKOHAU HARBOR

156°1'30" W  
19°40'20" N

TOLL FREE **888-458-7896**

[www.gentryskonamarina.com](http://www.gentryskonamarina.com)

The friendliest boatyard in Hawaii

*"Lectronic Latitude  
has lots of  
'Unique Visitors'!"*



- 'Lectronic Latitude can be found at [www.latitude38.com](http://www.latitude38.com)
- Four or five great stories with pictures every Monday/Wednesday/Friday
- A damn fine read
- Subscribe today at [www.latitude38.com](http://www.latitude38.com)

Aaron Kennedy, owner/skipper of the Beneteau First 36.7  
*Ay Caliente*, is one of thousands of 'Lectronic Latitude 'Unique Visitors'.



[www.latitude38.com](http://www.latitude38.com)

**44-FT BENETEAU 445, 1993.** St. Thomas, US Virgin Islands. \$129,000. Cruising ready performance cruiser/liveaboard located in the Virgin Islands. Watermaker, wind generator, solar, davits, AGM batteries, newer engine, navigation electronics, dinghy. <[ansano.com/4sale](http://ansano.com/4sale)> (340) 344-6262; [gil@ansano.com](mailto:gil@ansano.com).

**46-FT 461 BENETEAU OCEANIS, 1998.** Oakland Yacht Club Marina. \$215,000. Cruise equip. to include just about anything you can think of. Most equipment age very recent. Yes even air cond and generator. Boat's name is *Perfect* for a reason. Load up your food and go around the world. (510) 502-4828 or (510) 531-8058; [rwoltring@yahoo.com](mailto:rwoltring@yahoo.com).

**42-FT BENETEAU, 2003.** Brickyard Cove. \$165,000. Cruise ready, with solar with large house bank, upgraded windlass and watermaker, conventional sail w/stack pack. This is a well-crafted French-built boat. (510) 847-9854.



**CAPE DORY CUSTOM 40, 1989.** Loreto, Mexico. \$130,000. True blue water cruiser. Alberg design. Hull #15 of 16. Westerbeke diesel. Cutter rigged. Full sail inventory. New watermaker, solar panels, standing and running rigging in fall 2008. Certified liferaft, AB aluminum dinghy, Yamaha 15. Call (425) 327-5225; [jsoulkitchen@gmail.com](mailto:jsoulkitchen@gmail.com).

**47-FT CATALINA, 2002.** Santa Cruz. \$239,000. 460 engine hours. Infurling main. Electric winch. Captain's chairs. Complete nav pac. Professionally maintained. Cleanest Catalina around. A like-new boat at a fraction of the price. Call for specs and pics. (831) 429-1970.

### INTERNET FRAUD

Recently, we've been getting another tidal wave of reports of Internet scams, so we feel compelled to warn you once again about this unfortunate aspect of human nature. If somebody wants to buy your boat sight unseen, and suggests sending you a cashier's check for more than the asking price, trust your instincts. It is too good to be true. Usually they want you to cash the check and return the remainder to them for shipping costs. Then, much later, the bank informs you that the check was no good. We recommend that you don't even respond to the initial email inquiry. For more info on these cons, see: <[www.craigslis.com/about/scams.html](http://www.craigslis.com/about/scams.html)> Brave New World.

## 51 FEET & OVER



**FORMOSA 51 KETCH, 1981.** Documented. 3 br, 2 bath home; adventure included. Loving care by 2nd owner for 24 years. Sitka spruce spars, stainless steel crow's nest. Roller furling main (boomless), staysail. Maroon covers. Teak interior, varnished throughout. Benmar autopilot, radar, VHF, 80-hp Ford Lehman diesel, diesel heater, new propane range, propane water heater, coldplate freezer/fridge. 220 gal. fuel/220 gal. water. 3 staterooms, 2 heads. Set up to singlehand. Price reduced: \$97,500. Lying Santa Cruz. Call (650) 326-1430 or [ewhollandjr@aim.com](mailto:ewhollandjr@aim.com).

## CLASSICS



**32-FT NEW PROTHERO CLASSIC** wood gaff cutter, 2008. Anacortes WA. \$68,000. 32' overall, 26' on deck. Heavily constructed, fine handling, attractive cutter designed and built by Puget Sound master boatbuilder Frank Prothero. Cedar on sawn fir frames. Traditional rigging. Yanmar diesel. 6+' headroom. Sleeps 3. Rare opportunity to own a new traditionally-built classic sailboat. Email or call for photos/details. (360) 707-0588; [seabird@wavecable.com](mailto:seabird@wavecable.com).

**35-FT WALRUS, 1946.** Sausalito. Double-ended ketch. New Zealand built. Triple-planked, kauri pine, copper riveted. 30 hp Sabb diesel. Just back from Panama. Mike. (415) 312-3364.

## MULTIHULLS

**34-FT GEMINI 105M, 2000.** Point Richmond, Brickyard Cove. \$130,000. Get in on the multihull fun with the world's most popular cruising catamaran. Well equipped, three headsails, traveler, davits, 14' beam fits in most 40' berths. Great Bay boat, proven bluewater design. Call (510) 367-0500 or [kirk@seguecon.com](mailto:kirk@seguecon.com).

### CC RIGGING

*Rigging replaced at your slip.*

Watermakers • Autopilots • Anchoring  
Chris (510) 338-2165 • [CC\\_Rigging@hotmail.com](mailto:CC_Rigging@hotmail.com)

### AIRCARDS FOR WIFI SERVICE

Anywhere on land or sea where there is cell coverage. Great prices! Heavy users now need more than one card to save big! Stop limiting yourself and ask about free laptop card offers.  
[yarboat@msn.com](mailto:yarboat@msn.com) • (435) 216-6655



**55-FT CATANA 531.** Newport Beach. \$549,000. Cruise the world in comfort, speed and safety. Excellent condition, many spares, sprit, 2004 Yanmars with sd40s, 8.5kw, 55-gph watermaker, stall shower, 5 electric winches, good sail inventory, many upgrades. 3 autopilots, SSB, radar, Inmarsat mini-M, MicroCommander controls, 12' Caribe with 25 hp, solar array, ProFurl electric jib furler, computer with world charts, new Sealand electric heads, inverter, much much more. High quality. Prime Newport Beach mooring available. Call (949) 295-4116 or (949) 675-0617 or jerrywoods37@hotmail.com.



**CROSS 42, 1982.** Morro Bay. \$90,000. Trimaran ketch, beautiful mahogany and white laminate interior, yard-built cold-molded pressure treated wood/epoxy, Perkins 4-108, Max Prop, SSB radio, 2 symmetrical and 1 asymmetrical chute, roller furling headsail, well equipped. (805) 541-4417 or (805) 704-8613; gabarker@sbcglobal.net.

**31-FT CORSAIR F-31UC TRIMARAN,** 2007. San Diego. \$129,000. New ultimate cruiser purchased in 2007. Spec'd out for long range cruising, loaded with factory options and additional cruising gear; unfortunately, she was never sailed- ever! Offering 'No qual' financing. Details available to serious sailors. (619) 319-0316.



**25-FT TRINADO TRAILERABLE TRI,** 1998. Shilshole Marina Seattle. Brown, Bieker, Irens-designed performance trimaran for sale. Exceptionally well built. Excellent condition. Many pictures & full details on web: <www.ptfoils.com/hum-dinger.html>

**34-FT GEMINI 105MC, 2005.** Redwood City, CA. \$160,000. Shipped August 2005. Screecher, hammock seat, microwave, Furuno NavNet GPS/radar/target tracking/fishfinder, ProSine 2000W inverter/charger, NewMar battery monitor, 200AH gel batts, AB RIB/8HP Honda 4 stroke, Fortress F28, Honda EU2000 gen., new upholstery & bottom 6/09, more! <loona-sea.gibbons.web.stanford.edu> (650) 380-3343; brian.j.gibbons@gmail.com.



**38-FT ATHENA CATAMARAN, 1995.** La Paz, Mexico. \$169,000. Fully equipped cruising boat with numerous upgrades. Pack a bathing suit and go. Go to website for pics and specs. <home.mindspring.com/~kkcordes/id22.html> (510) 708-9671; kkcordes@mindspring.com.

**31-FT CORSAIR F31 AFT-CABIN, 1999.** Alameda. \$92,000. Hull #143, Excellent condition, rotating mast, full roach main, furling jib, screecher, spinnaker, carbon bowsprit, galley, head, Raymarine depth and autopilot, custom stern arch, solar panel, bimini, 9.9 Yamaha, Trailax aluminum trailer. (650) 465-2206; denismcarroll@hotmail.com.

## POWER & HOUSEBOATS

**28-FT PROTECTOR, 2001.** Lake Tahoe. Beautiful center console Protector. 99% fresh water use. Two 225-hp Yamahas, under 400 hours. Teak sole. Rear seat. GPS/chartplotter. VHF. Excellent condition and very fast. (530) 583-4000 or (530) 518-8500 or GD@DorlandProperties.com.



**PRICE REDUCED. 30-FT WILLARD** Vega Searcher. Excellent little ship for 2, good for 4. Super condition in/out. All systems in excellent condition. Full electronics. All safety gear, full head, 100 gals fuel, 100 gals water. See to appreciate. Call (650) 207-6898 or (650) 851-3402.



**65-FT WOOD CLASSIC, 1939.** Heavy built ex-trawler. GMC 12V-71, 21-kw generator. Full electronics. Lots of equipment. Ready to go. Would make great conversion. More pics/details: ancona@mcn.org. Will consider any reasonable offer. Call (707) 964-5423.



**43-FT DELTA COUNTRY BOAT, 1979.** Sausalito. \$85,000. This is a great boat for comfortable living aboard. She has a full galley with propane 3-burner stove/oven, head, double-bed stateroom aft, long V-berth in bow, sitting room and living room. There is a flying bridge with new bimini cover where a 360 view is gorgeous. There is a full 27-in TV/entertainment center. Loads of storage all over the boat. Two 225-hp Mercruiser engines. Boat well maintained. New paint. (415) 331-7480.

**43.5-FT LABELLE TRAWLER.** Sausalito. Outstanding view berth. Volvo diesels, 500 hours, 7.5 Onan. Roomy glass-enclosed sundeck. Full canvas. Large custom galley. Master with walkaround queen, tub + comfortable guest stateroom with large bed, head. Excellent workmanship/condition. Will sacrifice. May finance, rent or trade. (415) 331-5251.



**24-FT BAYLINER-CIERRA, 2002.** Oyster Point Marina, San Fran. Bay Area. \$30,000. Hardtop cruiser with Pacific trailer, 5-liter Mercruiser, full galley with microwave, head, inverter for 110 volt, fully equipped, Eagle Intellimap GPS, new radio, Garmin fishfinder, new boat cover, full canvas, new interior, new stainless Magma BBQ and color 5 in TV. All manuals. Excellent condition. Call or email Stephanie for details: (650) 342-8535; s.kiewlich@comcast.net.

## PARTNERSHIPS



**35-FT J/109, 2004.** Belvedere, CA. J/109 sailboat partnership. Mint condition J/109. Active SF racer/cruiser. 1st in SF Bay J/109 Division, 3rd in 2008 PHRF. Also, great family cruiser, sleeps 6+, full kitchen, for Delta, Bay or coast. Interested parties only: (415) 717-3664 or (415) 819-4589 or ahoys@earthlink.net.

**44-FT BENETEAU.** Sausalito Marina. 3 cabins. 3 heads. Perfect shape. Flexible equity or non-equity partnerships. (415) 472-1992 or (415) 713-9515; bob.irby@microfocus.com.



**ONE-THIRD EQUITY SHARE.** South Beach Harbor, San Francisco. \$17,500. 1988 34-FT BENETEAU 350, 2 cabins/1 head. New standing rigging & safety lines. Haul 'out done spring '09. 2 sets of sails, furling jib/main, asymmetric spinnaker. Solid coastal sailboat. (925) 640-4226; r.d.green1@comcast.net.

**CATALINA 30 SHARE.** Sausalito. Best Sausalito slip with parking. 5 min. to Bay, 30 to Angel Island. Walk to bars/restaurants. Upgrades: Wheel, diesel, cushions, jib furler, mast, more. Non-equity use 7 days max/month. 1 year, \$270/month. Call (415) 332-5442; Leeloves2sail@hotmail.com.

**BENETEAU 39.** Sausalito. Quarter usage \$500/mo. Downtown Sausalito slip. Well maintained 2002 cruiser/racer. Fine sailing, beautiful interior. Full electronics, classic main, furling jib. Equity or 1/8 usage also possible. <marigotgroup.com/strider> (415) 332-4401 or (415) 331-4900; Email: 393@marigotgroup.com.

**CATALINA 380, 2001.** Sausalito, CA. 1/8 to 1/4 equity share starts at \$325 month plus buy-in. Loaded with equipment & electronics. In-mast furling main. Easy to sail. Maintained in excellent condition. Very organized partnership. <http://picasaweb.google.com/sailbarca/2001Catalina380> (415) 235-6033; sailbarca@gmail.com.

## MARINE ENGINE CO.

Complete Engine Services • Gas & Diesel  
30 Years Experience • Reasonable Rates  
Tune-Ups • Oil Changes • Engine Rebuilding, etc.  
(415) 332-0455

## PROFESSIONAL DELIVERY CAPTAINS

San Diego based, USCG Master 100 GT. Sail and power. ASA-certified instructional deliveries. Panama Canal and Hawaii crossing experienced.  
(619) 913-7834 • davidhbrotherton@yahoo.com

Classy  
Idea!!

www.latitude38.com

Place your Classified Ad on our Website with your credit card. Fast, easy, convenient and secure. Deadline is always the 18th at 5pm. Your ad will run in the magazine, then be posted on the Website. Try It!

## MULTIHULL YACHT DESIGNER • MARINE SURVEYOR

John R. Marples, CMS • Certified, National Association of Marine Surveyors  
Multihull Design Specialist • Pleasure and Commercial  
Design office for Jim Brown Searunner, Seaclipper & Constant Camber Multihulls  
www.searunner.com • (707) 343-1378 • marplesmarine@comcast.net



**FAST SHIPPING!**

## NEW AND USED SAILS!

Specializing in production boats and featuring the largest selection of stock sails available anywhere! Save with warehouse volume discounts on Stock Sails, Custom Sails, Sail Covers, Furlers and Accessories. All top Quality.

**All Fully Guaranteed!**

- Full Batten Mains
- Furling Genoa's
- Storm Jibs
- Trysails
- Furling Units
- Custom Canvas
- Used Sails

**THE SAIL WAREHOUSE**

VISA **THE SAIL WAREHOUSE** MasterCard

Ph. (831) 646-5346 www.thesailwarehouse.com

**"YOUR DESTINATION FOR A FULL SERVICE MARINA"**  
**800 SLIPS 20-60 FT**

## Clipper Yacht Harbor

Sausalito, Ca

**BRAND NEW CONCRETE DOCKS!**

- Dry Storage Available
- Fuel Dock
- Salty's Bait & Tackle
- Sport Fishing
- Restaurant
- West Marine
- Launch Ramp
- Pump Out
- Laundry Facility
- Private Restrooms and Showers
- Anderson's Boat Yard
- Guest Slips Available

**310 Harbor Drive, Sausalito, CA 94965**  
**(415) 332-3500** • [www.clipperyacht.com](http://www.clipperyacht.com)

**BLUE PELICAN MARINE**  
 Nautical Consignments

[www.bluepelicanmarine.com](http://www.bluepelicanmarine.com)

*A Sailor's Consignment Chandlery*

Official Sponsor  
 2009  
 BAJA  
 HA-HA

**510-769-4858**  
 Located at Grand Marina  
[www.bluepelicanmarine.com](http://www.bluepelicanmarine.com)

# VOLVO PENTA

ENGINES • PARTS • SERVICE

**1-800-326-5135**

We Ship Anywhere

Call us for your nearest Volvo Penta dealer  
**1-800-326-5135**

**HELMUT'S MARINE SERVICE INC**  
 AUTHORIZED POWER CENTER

(415) 453-1001  
 FAX: (415) 453-8460  
[www.helmutsmarine.com](http://www.helmutsmarine.com)  
 619 Canal Street  
 San Rafael, CA 94901

**25-FT SANTANA 525, 1978.** 1/2-1/3 partnership. Alameda Marina. \$2,000-\$3,000. Great condition. Trailer, new 5 hp Honda, spinnaker, genoa, 90% main, new radio/CD player, newly covered cushions, new battery, mostly dry sailed. Need experienced, reliable sailor to enjoy this fast and roomy daysailer – share storage/upkeep expenses. (510) 790-2145; ravandenbergl@sbcglobal.net.

## SOUTH OF THE BORDER

**CONDO RENTALS NEAR VALLARTA** yacht club. Two adjacent condos overlooking Paradise Village Marina. Each 2 br, 2 bath with Jacuzzi, pool and amenities. Access to Sports & Beach Club. Rent one or both. Call (925) 208-1601 or 011-52 (322) 297-7559 or nwardmoore@gmail.com.



**CHARTER DIRECT & SAVE \$\$\$\$.** Owner's time available for discount charter. Beautiful Moorings 4600 cat, *Hope*, featured in *Latitude 38*. Based in beautiful Belize. Book direct and save big bucks. dpetty@thoratec.com.



**PLAN YOUR MEXICAN GETAWAY NOW** at the brand-new, gorgeous Cielo Y Mar condos. Located in Punta Mita, 35 minutes from Puerto Vallarta, available to rent from private owner. Right on the beach, 10 feet from the water, they offer spectacular views of ocean and mountains, the biggest infinity pool in the area, an endless beach, great surf breaks, great fishing, tremendous views of whales, bird life and the islands. While uncrowded and tranquil, just a five-minute walk to several waterfront restaurants. Choose from a spacious, beautifully furnished one or three-bedroom unit, or an amazing two-story penthouse with lovely shade trellis on the top floor. See details: <[www.puntamitabeachfrontcondos.com](http://www.puntamitabeachfrontcondos.com)> To reserve, call (415) 599-5012.

## GEAR

**SAILOMAT 601S2 WINDVANE** self steer. Oakland. \$950. Two vanes, works good, for 27'-35' boat. Also 8'6" West Marine RU-260 dinghy, good condition \$350. (650) 303-0560; p\_pady@hotmail.com.

**74-FT MAST DESIGNED** for catamaran. Best offer. (415) 269-5165.

**HARKEN FURLER.** \$900. Harken MKIII Unit 1 furler & manual. Pin to Pin: 31'7"; tack to clew: 29'11" Installed on stays'l in 2006 on Westsail 32 but NEVER used. KKMI just removed it; paid \$1600. Located Point Richmond. Email valerioce@yahoo.com or call (408) 813-0964 or (408) 377-5115.

**FOULIES.** Henri Lloyd offshore foul weather coat and pants built in harness used once, great shape. \$200. Size men's lg. Standard Horizon VHF handheld radio 12 volt charger \$150 best offer. Email Vonnien@Canby.com or call (503) 266-2257.

**SAILS.** San Francisco. Nearly new North sail (used 15/20 times) 7 oz. soft Norlom from Ranger 29. Hoist 37 ft; foot 15 ft. \$500. Spinnaker hoist 37 ft; foot 22 ft. \$300. (415) 566-5401.

**FLEMING GLOBAL 501 WINDVANE.** Beautifully engineered Fleming Global Equipe 501 windvane in great condition. Read about it at the Fleming website: [www.flemingsselfsteer.com](http://www.flemingsselfsteer.com); complete with carbon fiber paddle, wheel adapter, and instructions. \$2,900 or best reasonable offer. (253) 265-6234; ericstephan@pelicandental.net.

**55-FT ALUMINUM MAST, RIGGING,** boom, sails, from 40' freshwater sloop. Main, furling 135, furling gear, working and staysail. Also Perkins 4-108, Viking-40 aluminum anchor, chain and rode, winches, bosun's chair and more. Lake Tahoe. Call Douglas for list and prices. (775) 588-1881.

**VOLVO MD6B.** Berkeley. Single owner. 210 actual hours. Well maintained. Can hand crank. All parts and manual. Best offer over \$2,000. Call (510) 655-4740; farallon29@hotmail.com.

**PARANCHORS, DROGUES, SURVIVAL** suits, Powersurvivor35 watermaker, Trace inverter, Garhauer RT-8 radar/windmill pole, deluxe heavy stainless davits, BBQ, electric windlasses, marine SSB, automatic tuner, Outbacker Marine antenna, Avon, heaters: SIG270 diesel, Shipmate kerosene, Colestove. Hatches, Delta 44, CQR25, dive gear, CNG water heater, sails! Contact (415) 497-3731; brad-low@sbcglobal.net.

**BLUE PELICAN MARINE**

A sailor's consignment store located at Grand Marina, Alameda  
 Sails • Winches • Instruments • Blocks • Sailing Books  
 Charts • Outboards • Rigging • Hardware • Safety Gear • More  
**(510) 769-4858** • [www.bluepelicanmarine.com](http://www.bluepelicanmarine.com)

*Going Somewhere?* **Mexico • Caribbean • South Pacific**

Stop by our office and take a bundle of *Latitude 38* along with you.  
 We promise you'll be a hero for sharing them with other cruisers!  
**Latitude 38 • 15 Locust Ave • Mill Valley, CA • (415) 383-8200 • Open M-F 9-5**

## MISCELLANEOUS

**MOTOROLA IRIIDIUM SATELLITE** phone. \$1,200. Once used but still in original box. Many extras; external antennas, converter, charger, rechargeable batteries, more! Worldwide service. Was \$1,600. (650) 563-9164.

**LOST INFLATABLE REWARD.** Berkeley Marina. \$Reward. Please help me find my late model West Marine/Avon R310 RIB inflatable and blue 9.9 Nissan outboard, lost/stolen Berkeley Marina, this May. Couple of unique patches, repaired blue seat. Thanks, Paul. Call anytime. (510) 508-0151; pfertherston@sbcglobal.net.

## TRAILERS

**2007 TRIPLE-AXLE TRAILER.** \$5,500. Bow ladder, spare tire, eight supports, good tires. Used once to transport Nor'sea 27 (8,000 lbs. plus) from Florida to California. (650) 787-9428; m.y.nagayoshi@gmail.com.

## CLUBS & MEMBERSHIPS

**SINGLE SKIPPERS AND CREW** of all abilities are invited to join the Single Sailors Association. Membership includes daysailing, raft-ups, invaluable onboard training, social events. Meetings held 2nd Thursday, Ballena Bay Yacht Club <www.bbvc.org> Social 6:30 pm. Meeting 7:30 pm. Guests welcome. <www.singlesailors.org/> (510) 233-1064.

## NON-PROFIT

**MARIN POWER & SAIL SQUADRON:** 50 years offering tuition-free safe boating classes. America's Boating Class starts September 15, Tuesdays and Thursdays, 7 to 9 pm in Novato. Textbook \$40. For registration and information, call (415) 924-2712.

**SAILING SKILLS AND SEAMANSHIP.** A 13-week classroom-only course offered by USCG Auxiliary. Class meets Tuesdays 7:30 p.m. beginning Aug. 11 at the Sausalito Cruising Club. \$75 fee includes a textbook. Enrollment is limited. Contact Margrit; margritkeyes@sbcglobal.net or (415) 924-3739.

**BOATING SKILLS AND SEAMANSHIP** (power) Sailing Skills and Seamanship (sailors) courses offered by USCG Auxiliary Flotilla 17. Learn: Essentials of boating/sailing and seamanship; Navigation; Weather; Communications; Knots. Tuesdays and Thursdays, September 8-November 5, 7:30-9:30 at YBI. \$75. (415) 285-1100; FSO-PE@flotilla17.org.

## PROPERTY SALE/RENT



**LIVE, WORK, PLAY.** Anacortes, WA. \$1,995,000. Two hours North of Seattle. Zoned maritime commercial, waterfront building. Ground level 3,500 sq. ft. offices, two 60' slips, private elevator to 2BR/2Bath 1,780 sq. ft. condo. Photos/info at <www.maritimebldg.info> American Dream Real Estate (360) 588-1515; Leslie Freeman. <www.maritimebldg.info> (360) 661-2136.

**HAWAIIAN OCEANFRONT: BUY/RENT.** Oahu's north shore. 3br/2br totally remodelled home, 32 feet from water. Unique, secluded enclave offering expansive sandy beaches, water sports, historic towns, small harbor nearby. Rent to Latitude 38 readers starts at \$185/night. Some conditions apply. Creative sale possible. Let me help you find your Hawaiian dream. (415) 999-5626.

## BERTHS & SLIPS

**BERTH AVAILABLE.** San Francisco. 36-ft berth at Pier 39. Very close in. Rental by month or annually. (415) 474-2474.

**50-FT PRIME SLIP, PIER 39, SF.** \$46,000. F-Dock, Slip 11, east side. Protected from wind. Close to gangway, showers and marina office. Covered parking across street with special rates for owners. Call (559) 355-6572 or email: scorch@tempest-edge.com.

**SAUSALITO SIDE-TIE BERTHS** for 25 to 35-ft boat. Water, power, tile bathrooms with shower. Good prices. Special deal for boat being sold. (415) 999-5626.

**PIER 39, SF, 36-FT SLIP FOR SALE.** \$8,500/obo. Great location on C-dock, double finger slip. All amenities: parking, utilities, showers and more. Hurry - at this price, it won't be available for long. For more information contact Myra (415) 495-7130.

## CREW

**J/105 CREW.** SF Marina. New 105 Capitan looking for crew to do beer can races this season and move into one design by next. (650) 534-6742; marcvcayn@gmail.com.

**LOOKING FOR CREW.** Owner of Formosa 51 needs able-bodied M/F to help sail on S.F. Bay. Would like to sail weekdays, twice per week, weather permitting, from berth right on the Bay. Two or three sailors best, however, room for more if interested. John (510) 388-5534.

**I AM LOOKING FOR** an ocean crossing opportunity. I have two years racing experience on boats ranging from 25-50 feet. I work pit, mast and foredeck. Preferably a CA-Hawaii passage and back. Any Pacific crossing will do. Mike: (310) 821-4392; catshadowzoo@yahoo.com.

**PROFESSIONAL PHOTOGRAPHER** Dan Merkel, 'Surfing' magazine, 'Big Wednesday', 'Endless Summer II', 'Free Ride', etc. Travel 9/10; South Pacific, etc; monohull 48-ft-up. Power 62-ft up. Photography islands, beaches, waves. Check out: www.danmerkeldmedia.com.

## PERSONALS

**PERSONAL ASSISTANT AND/OR** boatworker. One or two people, pt or ft, help with business, organization, upgrading boats. Interests in mortgage and real estate brokerage, boat remodeling, sales. Sausalito. Ability to travel a plus. Lodging possibly included. (415) 331-5251.

## TRYING TO LOCATE

**LOOKING FOR Celeste 42'** steel sailboat. Old friend looking to pay respects. Hope you are well. Barrett, Hawaii. Email: dbarrett@hawaii.rr.com or call (808) 385-2613.

**LOOKING FOR DESTINER,** 36-ft double gaff schooner. In Bay Area 1970s, owner Karn(?). Would love to know what's become of her. ken@skookumpeak.com.

## JOB WANTED

**MARINE JOB** or work wanted. Strong 18-year old, some experience in boat repair (apprentice carpenter, sanding, painting, rigging). Also experience in customer service. Lifelong sailor, good refs, College of Marin student. Available full-time through 8/16, part-time after. Contact Baylis: (415) 389-9378.

## JOB OPPORTUNITIES

**F/T SALES POSITION** in Marine Electronics. Must have a minimum of two years in the marine industry, sales experience, car, and the ability to work with customers. Send resume via email to: Donatini@comcast.com or mail to: Johnson Hicks, 333 Lake Ave., Santa Cruz, CA 95062 Att: Joe Donatini.

## TOO LATE TO CLASSIFY

**1979 CHB 45** Europa bluewater trawler. Previously used as a research vessel and well maintained. GPS color chartplotter. Radar. Sedan style. Beautiful vessel. Twin 165 turbo Perkins - so very fuel efficient. needs a bit of care but a steal at \$79,000. (831) 915-8190.

**TARTAN 34 CLASSIC.** 1978 S&S design. Olin Stephens said one of his best. Hull 505; one of last produced. Fully equipped. refrig., auto steer. Priced right. See it now if you want more than a playing! (916) 257-2910.



## SEVERAL LARGE END-TIE BERTHS ARE NOW AVAILABLE!

*Easy access to the rest of the Bay.*

Available sizes are 37-, 42-, 68- and 94-foot long. Ideal for large yachts or multihulls. (510) 236-1013 • Info@mbayharbor.com • www.MarinaBayYachtHarbor.com

## LIVEBOARD SLIPS AVAILABLE ON THE NOYO RIVER

Fort Bragg, CA. Minutes from Mendocino

*Includes water, power, wifi, bathrooms, showers, laundry.*

Dolphin Isle Marina • Toll free: 866-964-4113

## THIS COULD BE YOU...

*Let the Classy Classified business ads work for you.*

Submit online at:

[www.latitude38.com](http://www.latitude38.com)

*Need Crew?* **Latitude 38 Crew List** *A Boat to Crew on?*

Visit our website and sign up as Skipper or Crew • It's Free  
Find out about our next Crew Party: Wed. Sept. 9 at Encinal Yacht Club  
More info: [www.latitude38.com/crewlist/Crew.html](http://www.latitude38.com/crewlist/Crew.html) or call (415) 383-8200



# COMPUTER ABOARD?

CAPN & Digital Charts  
 AIS • WiFi • Cellular Amps  
 SatPhones: Iridium & Globalstar  
 HF SSB Radio & Pactor Modems  
*Wireless E-mail*



**SEATECH SYSTEMS™**  
 800.444.2581 • 281.334.1174  
 info@sea-tech.com • www.sea-tech.com

Call for Info on SeaTech Packages and CAPN Demo Disk

## ATLANTIC 57 CATAMARAN™



THE ORIGINAL PILOTHOUSE CATAMARAN  
 • Designed for easy shorthanded cruising  
 • Spectacular windward performance  
 • Cored epoxy/glass/carbon construction  
**CHRIS WHITE DESIGNS**  
 TEL: 508-636-6111  
 www.chriswhitedesigns.com

## GOLDEN STATE DIESEL MARINE

PARTS  
 YANMAR • UNIVERSAL • WESTERBEKE  
 PERKINS • ISUZU • PATHFINDER • ATOMIC 4  
 SERVICE  
 DIESEL ENGINES

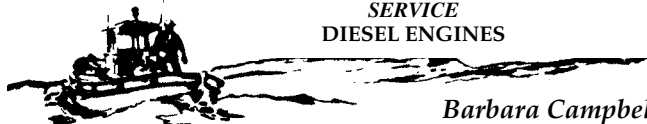

Barbara Campbell

351 EMBARCADERO  
 OAKLAND, CA 94606

(510) 465-1093

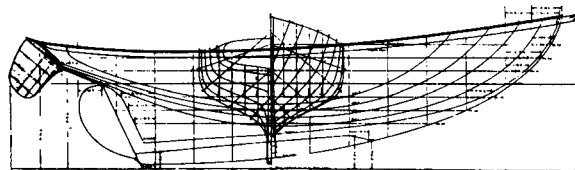

## MAKELA BOATWORKS

Family owned since 1948

Wooden Boat Building • Repair and Restoration

19280 South Harbor Drive • Fort Bragg, CA 95437

(707) 964-3963

email: howard@makelaboatworks.com • www.Makelaboatworks.com

weatherguy.com

## Worldwide Marine Forecasts Cruising, Racing & Commercial

Packages Starting at \$65.00 USD

(866) 882-WXGY (9949) toll free  
 (808) 291-WXGY (Mobile)  
 (808) 254-2525 (Office)  
 (808) 443-0889 (Fax)



970 N Kalaheo Ave  
 Suite C-104  
 Kailua, Hawaii 96734  
 info@weatherguy.com

www.weatherguy.com

## Ryan's Marine

Specializing in Marine Electrical Services  
 for Your Boat

- Electrical system installations from inverters to electronics packages
- Troubleshooting of existing systems
- Dealer for the complete Balmar product line
- Head and holding tank installations



(510) 385-3842

Ryan Schofield  
 Owner since 1997

email:  
 rssailor@yahoo.com

## Bilge Steam Cleaning Oil Changes

Professional service at your slip!!!



877 744-2244  
 www.MarineLube.biz



Fuel Polishing

Tank Cleaning



## PRIME FABRICATION

Marine Hardware and  
 Custom Metal Fabrication

- Stainless Anchors - Plow, Fluke, Claw & Ace
- Table Pedestals • Flopper Stoppers
- Helm Seats • Handrails



Ph 949.496.1348  
 Fax 949.496.1341  
 www.primefabrication.com  
 33081 Calle Perfecto, Suite B  
 San Juan Capistrano CA 92675



**1,000 Used Sails**  
Listed at  
[minneysyachtsurplus.com](http://minneysyachtsurplus.com)

**We Buy Good Used Sails  
and Marine Equipment**

**MINNEY'S YACHT SURPLUS**  
1500 Newport Bl., Costa Mesa, CA  
949-548-4192 • [minneys@aol.com](mailto:minneys@aol.com)  
*"We keep boating affordable!"*



Norman Diego's  
**THE MEXICAN INN**

CABO SAN LUCAS

Abasolo y 16th Septiembre  
Next to the Port Captain's Office

**UNPRECEDENTED OFFER FOR BAJA HA-HA:**  
*1st nite FREE with 2 nites paid - for all entrants!*  
*Call us today!*

[www.themexicaninn.com](http://www.themexicaninn.com)

U.S.: (866) 434-3467 • Cabo: (624) 143-4987

**MARINE OUTBOARD COMPANY**

Johnson  
Evinrude  
Mercury  
Nissan



Tohatsu  
Mariner  
Honda  
Yamaha

(415) 332-8020

Our certified technicians have repaired, rebuilt, repowered and serviced outboards and boats since 1990 for less than anywhere else in the Bay Area. How? Less overhead... All repairs and parts come with a 1-year warranty; 3-year warranty on new Nissan engines.

35 Libertyship Way • Sausalito, CA 94965

The NEW NOW UNDER CONSTRUCTION

**MARINA**  
nuevo vallarta  
*habia de banderas ayuria!*

Official Sponsor  
2009  
BAJA  
HA-HA

- 230 Mooring Spaces 22'-130' long
- 15-year long-term lease available

Contact Dockmaster: Juan Sebastian Estrada  
Ph/Fax from US: 011 52 322 297 7000  
[juan@marinanuevovallarta.com](mailto:juan@marinanuevovallarta.com)  
[www.marinanuevovallarta.com](http://www.marinanuevovallarta.com)

**Mathiesen Marine**

For All Of Your Electrical & Electronic Needs

Not just quality installations...

**We are your source for  
Marine Electronics!**

All major brands at great prices!

Experience the professional difference by hiring a ABYC Certified Master Technician

Electronics, PC & Mac based Navigation Systems Integration, Radar, Autopilots Corrosion Issues, Inverters, Battery Banks



-Fully Insured-

(510) 350-6622 [www.MathiesenMarine.com](http://www.MathiesenMarine.com)

**RPARTS**

REFRIGERATION PARTS SOLUTION

WE MAKE YOU THE EXPERT



"Do-It-Yourself" with RParts at unbeatable prices. We can help you fix a system or build it new.

Assembled Water-Cooled DIY Kit shown

[www.rparts.com](http://www.rparts.com)

**ADVERTISERS' INDEX**

AB Marine.....58	Baja Ha-Ha Sponsors .....	Blue Pelican .....	BVI Yacht Charters.....141	Coyote Point Marina.....49
Adventure Cat Charters.....142	.....113,114,115	Blue Water Yacht Insurance ..64	Cal Marine Electronics.....61	CPT Autopilots.....172
Aeolian Yacht Club.....120	Ballena Bay Yacht Brokers.....174	Bluestorm.....121	Call Of The Sea.....12	Cruising Yachts.....12
Aeolian Yacht Club.....67	Ballenger Spars.....97	Bluewater Network.....174	CDI/Cruising Design .....159	CYOA Yacht Charters .....141
Alameda Prop & Machine ....162	Bay Island Yachts.....10	Bo'sun Supplies.....172	Charlie's Charts .....68	Dept. of Boating &
Allstate .....70	Bay Marine Boatworks.....63	Boat US .....18	Chula Vista Marina .....156	Waterways/Clean Vessel.....15
Almar Marinas .....17	Bay Marine Diesel .....172	BoatSmith Marine Carpentry	City Yachts .....11	Desolation Sound Yacht
American Battery.....172	Bellhaven Yacht Sales &	and Boatbuilding.....10	Clipper Yacht Harbor.....168	Charters.....142
Anacortes Yacht Charters....142	Charters.....142	Boatswain's Locker .....18	Coast Marine .....124	DeWitt Studio.....125
Anderson's Boat Yard .....19	Berkeley Marina.....73	Boomkicker.....173	Conch Charters.....141	Diesel Fuel Filtering.....173
Annapolis Performance	Berkeley Marine Center.....35	Bottom Siders.....166	Costa Baja Resort & Marina .39	Downwind Marine.....42
Sailing .....95	Beta Marine Engines.....133	Brisbane Marina.....14	Cover Craft .....124	Doyle Sails.....31



**Marine Diesel Specialists  
AT YOUR SLIP!**



30 years experience • Universal/Westerbeke dealers  
Repairs/Tune-ups all models • Engine Surveys, Instruction

**BAY MARINE DIESEL 510-435-8870**

[baymarinediesel@comcast.net](mailto:baymarinediesel@comcast.net)

**QUALITY CRUISING SAILS FOR LESS!**



**MAINSAILS  
MIZZENS  
STAYSAILS  
HEADSAILS  
SPINNAKERS  
SAILCOVERS  
STRONGTRACK**

(510) 523-3337 • [leesailsnc@yahoo.com](mailto:leesailsnc@yahoo.com)

2021 Alaska Packer Pl. • Grand Marina • Alameda, CA 94501

**SAILMAKER TO THE WORLD**

**TIRED OF HAND STEERING?  
GET THE CPT—THE RELIABLE, POWERFUL WHEEL PILOT**

- Dependable ♦ Built for Immersion
- Affordable ♦ Easy Owner Installation
- Quiet ♦ Low Power Consumption

The Delivery Skipper's Favorite

**CPT  
AUTOPILOT**

831-687-0541

*See it in Action!*

[www.cptautopilot.com](http://www.cptautopilot.com)



**MARINE BATTERIES**

**LIFELINE**  
...the heart of your system®

Available at the following local marine chandleries and service distributors:



**ALAMEDA**

- Alameda Prop & Machine
- Fortman Marina Store
- The Boatyard at Grand Marina
- Star Marine
- Svendsen's Chandlery

**BENICIA**

- Cruising Seas Services

**MARTINEZ**

- Diablo Marine

**OAKLAND**

- Golden State Diesel
- Outboard Motor Shop

**OAKLEY**

- Big Break Marina

**RICHMOND**

- Swedish Marine

- Bay Marine

**SAUSALITO**

- Sausalito Marine

**AMERICAN BATTERY • Hayward, CA • (510) 259-1150**

**STAINLESS STEEL  
RATCHET BUCKLE & STRAP**

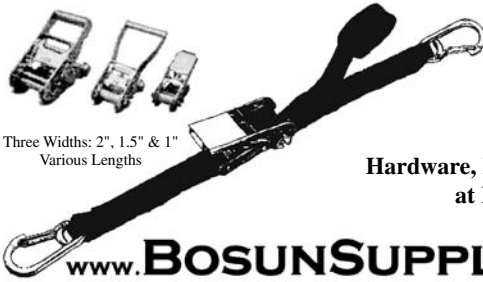

Three Widths: 2", 1.5" & 1"  
Various Lengths

*Strength, Quality  
& Dependability...  
with a Lifetime Warranty!*

**Stainless Steel  
Hardware, Rigging & Fittings  
at Reasonable Prices.**

[www.BOSUNSUPPLIES.COM](http://www.BOSUNSUPPLIES.COM)

Or call toll-free for catalog and to order

See our complete catalog & order on the Web **1(888) 433-3484**

**DONATE YOUR VESSEL**



- Donate your boat or equipment for a tax deduction
- Learn about our For Sale by Owner program plus tax deduction
- Topside cleaning service, \$2.00/foot



**Fundraiser for Ship 65 Sea Scouts  
and Maritime Learning Center**  
[www.seaeagle.homestead.com](http://www.seaeagle.homestead.com)

**650-380-5535**

**ADVERTISER'S INDEX - cont'd**

Easom Rigging .....107	Gianola Canvas Products....164	Hotel Coral & Marina .....158	Boatyard .....180	Lowrie Yacht Harbor .....125
Elliott/Pattison Sailmakers....94	Glen Cove Marina .....135	Hotwire Enterprises .....173	Landfall Navigation .....133	Lunasea Lighting .....94
Emery Cove Yacht Harbor.....71	Golden State Diesel Marine 170	Hydrovane .....118	Landing School, The .....8	Makela Boatworks .....170
Emeryville Marina .....96	Grand Marina .....2	J22 Fleet .....37	Larry R. Mayne Yacht & Ship Broker .....25	Marina Bay Yacht Harbor.....59
Essex Credit Corp .....121	Hansen Rigging .....97	JK3 Nautical Enterprises .....176	Last Call Marine .....69	Marina de la Paz .....173
Farallon Electronics .....70	Helms Yacht & Ship Brokers/ West Coast Multihulls .....55	Johnson Marine, C. Sherman .....66	Lee Sails .....172	Marina Nuevo Vallarta .....171
Farallone Yacht Sales .....7	Helmut's Marine Service....168	Johnson-Hicks .....10	Leukemia & Lymphoma Society .....41	Marina Puesta Del Sol .....142
Flying Cloud Yachts .....176	Heritage Marine Insurance .121	Key West Race Week.....47	Lifeline Batteries.....18	Marina Real .....158
Fortman Marina .....62	Hidden Harbor Marina .....103	Kissinger Canvas .....16	List Marine Enterprises.....125	Marina Riviera Nayarit .....119
Fusion Catamarans .....103	Hogin Sails .....40	KKMI - Brokerage .....177	Loch Lomond Marina.....69	Marina Village .....27
Garhauer Marine .....57	Hood Sails .....45	KKMI - Full Service		Marine Emporium .....50
Genry's Kona Marina .....166				Marine Lube.....170

**MARINA DE LA PAZ** FULL SERVICE MARINA  
S.A. DE C.V.

*Friendly, helpful, fully bilingual staff*

All new hardwood docks • Wireless Internet  
Dinghy landing with potable water  
New protective piling & sheetpile breakwaters • And more!

TEL: 01152 612 122 1646  
email: [marinalapaz@prodigy.net.mx](mailto:marinalapaz@prodigy.net.mx)  
[www.marinelapaz.com](http://www.marinelapaz.com)  
Apdo. Postal 290, La Paz, 23000, Baja California Sur, Mexico

**MORE ENERGY!**

**KEEP BATTERIES CHARGED!**

- KISS wind generators
- Solar panels and MORE

**USE BATTERIES EFFICIENTLY!**

- LED lights
- Engel fridge/freezers
- Port fans and more



[www.svhotwire.com](http://www.svhotwire.com) **727.943.0424**

**Vessel Electric**

*Mobile marine navigation installations and expansions of existing systems*

- Class A, Class B AIS systems and digital TVs
- Raymarine® warranty dealer and certified installer
- NMEA-certified Marine Electronics Installer • Insured

**Raymarine** Milltech Marine AIS **NAVPOD**

**Brian Theobald • (415) 424-2204**  
[vesselelectric@yahoo.com](mailto:vesselelectric@yahoo.com)

**WEDLOCK, RAMSAY & WHITING**  
Marine Surveyors

Vessel surveys, consulting, deliveries.

*Serving the Bay Area since 1980*

[www.norcalmarinesurveyors.com](http://www.norcalmarinesurveyors.com)  
**(415) 505-3494**

**DF DIESEL FUEL FILTERING**

*Purify Diesel Fuel & Flush Tanks*

Process scrubs, polishes, removes algae, dirt, sludge, rust, water, and foreign particles from diesel fuel. Includes internal tank washdown. Save your injectors, costly engine repair and down time.

*Since 1989. Fully insured. Your berth or boat yard.*

**(510) 521-6797 Fax: (510) 521-3309**  
[www.dieselfuelfilterings.com](http://www.dieselfuelfilterings.com)

**EASYSTOW FENDERS®**

Easy to use and easy to stow. 6", 8", 10" and 12" diameters. Other sizes and models available. Guaranteed tough.

**PERFECT FOR THE BAJA HA-HA!!**

[www.easystowfenders.com](http://www.easystowfenders.com)  
**(800) 437-7654 • (708) 482-8801**

*Practical Sailor Rated BEST CHOICE*

ADVERTISER'S INDEX - cont'd

Marine Outboard Co.....171	Napa Valley Marina .....175	Oyster Point Marina .....132	Raiatea Carenage Services .154	Scanmar International.....107
Mariner's General Ins.....46	Nelson's Marine .....71	Pacific Crest Canvas .....67	Randall Burg Yacht & Ship...176	Schaefer Marine.....135
Maritime Institute .....68	Norpac Yachts.....179	Pacific Yacht Imports.....9	Richardson Bay Marina.....134	Schoonmaker Pt. Marina ....106
Marotta Yachts .....178	North Beach Marine	Passage Yachts .....5	Rooster Sails .....97	Sea Scouts .....172
Mathiesen Marine .....171	Canvas.....61	Peter Crane Yacht Sales.....175	Ryan's Marine .....170	Seashine .....73
Mazatlan Marine Center/ La Paz Yachts.....14	North Direct Sails.....12	Pier 32 Marina .....155	Sail California .....21	Seatech.....170
McDermot Costa Insurance ..72	North Sails - San Francisco...51	Pineapple Sails.....3	Sail California .....20	Seawind USA .....55
McGinnis Insurance.....118	North Winds Canvas .....67	Prime Fabrication .....170	Sail Warehouse, The.....168	Seaworthy Goods.....16
Milltech Marine Inc.....28	Opequimar Marine Ctr.....157	Punta Mita Beachfront Condos .....143,174	Sailrite Kits.....26	Shadetree Fabric Shelter .....69
Minney's Yacht Surplus.....171	Orange Coast College .....43	Pusser's Rum.....4	Sal's Inflatable Services .....107	Society of Accredited Marine Surveyors/SAMS .....162
Modern Sailing School & Club.....33	Outboard Motor Shop .....65	Quantum Pacific.....23	San Francisco Boat Works.....16	Solidnav.com.....56
	Owl Harbor.....102	R-Parts .....171	Sausalito Marine Electrical Shop/Artisan Marine .....72	South Beach Harbor .....60



# JUST YOU AND THE SEA...



...and the jacuzzi,  
the 80-ft long pool, the surf,  
the Punta Mita anchorage, and the 4-mile distant  
Tres Marietas Islands

## Punta Mita Beachfront Condos

Call now for reservations!

1.415.599.5012

[www.puntamitabeachfrontcondos.com](http://www.puntamitabeachfrontcondos.com)

**Avalon Cabo Rico 38'**  
Price Adjusted to \$169K

[info@ballenabayyachts.com](mailto:info@ballenabayyachts.com) 510.865.8600

## Donate your Boat

**Cars, Trucks, RVs, & Real Estate**

We handle all DMV & Smog

Running or Not (restrictions apply)

**Tax Deduction**

**BLUEWATER** | 800-324-7432  
NETWORK

"Proceeds help **Bluewater Network** reduce greenhouse gases, clean up our air and water, and protect marine mammals and wildlife."

### ADVERTISER'S INDEX - cont'd

South Beach Riggers.....61	TMM/Tortola Marine Management.....141	Voyager Marine.....164	Wooden Boat Foundation/ Festival .....65
South Beach Yacht Club.....53	Tradewinds Sailing .....112	Weatherguy.com .....170	Wright Way Designs .....134
Starbuck Canvas .....8	Trident Funding .....6	Wedlock, Ramsay & Whiting	Wyliecat.....135
Sun Harbor Marina .....159	Twin Rivers Marine	Marine Surveyors .....173	Yachtfinders/Windseakers.....8
Svendsen's Boat Works .....29	Insurance .....44	West Marine.....30,32,34,36	
Svendsen's Marine .....38	UK-Halsey Sails.....54	West Marine Rig .....52	
Svendsen's Marine .....132	Ullman Sails.....65	Westwind Precision	
Swedish Marine.....73	Vallejo Marina.....103	Details .....61	
Swiss Tech America .....71	Velas de Loreto/El Don.....140	Whale Point Marine	
The Boatyard at Grand Marina.....13	Ventura Harbor Boatyard....142	Supply.....48	
The Mexican Inn.....171	Vesper Marine .....156	White, Chris Designs .....170	
The Yacht Exchange.....175	Vessel Electric.....173	Wichard, Inc.....24	
		Windworks Sailing Center ..140	

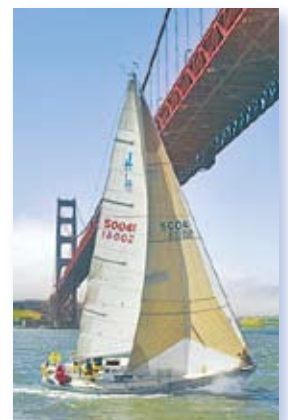



# Peter Crane Yacht Sales and Charters

We can help you find the right vessel to begin exciting adventures experienced in power and sail

call with your ideas we will search, preview assess and photograph possibilities

805 963-8000  
pc@petercraneyachts.com

## CELEBRATING OUR 50<sup>TH</sup> ANNIVERSARY



35' SANTANA  
1979, clean • \$16,500



37' IRWIN CENTER COCKPIT  
1972 • \$19,900



37' PROUT SNOWGOOSE CAT  
1985 • \$79,000



37' ISLANDER  
1968, nice interior • \$24,900



40' MARINER KETCH  
1973 • \$34,900



41' MORGAN OUT ISLAND SLOOP, 1974 • \$34,900



41' ATKINS INGRID FERRO CUTTER, 1971 • \$29,000



47' COLIN ARCHER STEEL PH KETCH, 1972 • \$79,000



51' ATLANTIC PH STEEL KETCH  
1995 • \$119,000



58' CUSTOM TRI  
2008, unfinished • \$58,000



45' ROUGHWATER KETCH  
\$44,900



## NAPA VALLEY MARINA

1200 Milton Road • Napa, CA 94559

(707) 252-8011 • Fax (707) 252-0851

[www.napavalley marina.com](http://www.napavalley marina.com)

Marina • Boatyard • Chandlery • Brokerage

Dealers for **YANMAR**

**Interlux**  
yachtpaint.com

Distributors for *Brownell*  
Boat Stands



THE YACHT EXCHANGE

"It's about the boat"

Marina del Rey, CA  
(310) 305-9192

[www.theyachtexchange.net](http://www.theyachtexchange.net)



PACIFIC SEACRAFT 37, 1999  
Full cruise ready. \$219,000



KELLY PETERSON 46, 1984  
Bristol and cruise equipped. \$249,000



HUNTER 466, 2002  
Full cruise ready. \$249,000

If you're thinking of the Baja Ha-Ha and beyond, these three boats are fully equipped for offshore blue-water sailing. They are turnkey: fuel, food and leave.

For full specifications, see [www.theyachtexchange.com](http://www.theyachtexchange.com)



SWAN 371  
Race winning record, great decks, new engine. \$109,900

SEEKING  
QUALITY SAIL  
LISTINGS





# Flying Cloud Yachts



**Hans Christian**



Sail • BROKERS • Power

6400 Marina Drive  
Long Beach, CA 90803

www.yachtworld.com/fcyachts  
flyingcloud@verizon.net

Phone (562) 594-9716  
Fax (562) 594-0710



54' HUNTER SLOOP, '81 \$94,500



47' GILS CATAMARAN, '02 \$395,000



44' GULFSTAR CC SLOOP \$104,500



44' HARDIN KETCH, '78 \$119,000



HANS CHRISTIAN 43T ketch \$165,000



43' SPINDRIFT PH CTR, '81 \$109,000



41' CHEOY LEE KETCH, '79 \$74,000



40' CATALINA 400 MkII, '02 \$179,000



35' SCHOCK SLOOP, '89 \$29,500



35' CHALLENGER SLOOP, '74 \$29,000



NEW GEMINI 105Mc, '09 \$162,500



33' HANS CHRISTIAN CTR, '85 \$120,000

MANY MORE LISTINGS ON OUR WEB SITE: [www.flyingcloudyachts.com](http://www.flyingcloudyachts.com) • Some boats shown may be sisterships.

## JK<sup>3</sup> BROKERAGE



38' TRUE NORTH EXPLORER, 2002 \$269,000



40' J/122, 2007 • \$440,000



40' DELPHIA, 2007 New, incredible value. \$199,000



40' J/120, 1998 • \$199,500

94' R/P Custom Maxi, '04...1,250,000	40' J/120, '99.....Sale Pending	34' Formula PC, '00.....95,000
79' Sparkman & Stephens, '79.....395,000	40' J/120, '94.....159,000	33' CrossCurrent, '07.....249,000
65' J/65, '06.....2,475,000	40' C&C 121, '02.....230,000	32' C&C, '84.....SOLD
55' Fairline Squadron, '00.....SOLD	38' True North, '05.....SOLD	32' J/32, '00.....118,500
53' J/160, '02.....679,000	38' True North, '04.....345,000	32' J/32, '98.....128,500
53' J/160, '97.....559,000	38' True North Explorer, '02.....two 269,000 & 279,000	31' Catalina 310, '01.....SOLD
52' TP52, '05.....525,000	37' Santa Cruz, '09.....New 399,900	30' Sabre Mk III, '87.....54,900
46' Moody, '00.....SOLD	36' Tiara 3600, '88.....80,000	29' Back Cove, '09.....New 232,000
46' Baltic, '76.....139,000	35' J/109, '06.....SOLD	29' Back Cove, '07.....199,000
45' Rivolta Coupe 4.5, '08.....745,000	35' J/109, '05.....215,000	29' Raider RIB 900 Sport, '08.....SOLD
43' J/130, '93.....239,000	35' J/109, '04.....209,000	29' J/29, '83.....25,900
41' J/125, '00.....399,000	35' J/105, '02.....115,000	26' J/80, '95.....32,900
41' J/124, '06.....329,000	35' J/105, '01.....118,000	26' Raider RIB 790, '03.....69,000
40' J/122, '07.....440,000	35' J/105, '97.....SOLD	22' Raider RIB 680, '07.....New 49,690



SAN DIEGO: 2330 Shelter Island Dr. #106  
(619) 224-6200 • FAX: (619) 224-6278  
NEWPORT BEACH: 251 Shipyard Way, Suite A  
Toll-Free: (866) 376-7761  
Tel: (949) 675-8053 • Fax: (949) 675-0584

Jeff Brown, (619) 709-0697 John Zagorski, (310) 947-2092

www.jk3yachts.com

YACHTWORLD.COM

## Randall Burg YACHT AND SHIP, INC.

info@rbyachts.com

www.rbyachts.com

Richmond (510) 232-1490  
Marina del Rey (310) 574-9449  
Newport Beach (949) 675-5940  
San Diego (858) 208-8888

### ◆ BANG FOR THE BUCK ◆



53' BENETEAU 523, 1996  
Marina del Rey \$539,000



51' BENETEAU 510, 1993  
Newport Beach \$229,000

### YOUR SHOPPING LIST: START HERE

SIZE	TYPE	LOCATION	PRICE
80'	COOPER QUEENSHIP MOTOR YACHT, '91	DELTA	\$695,000
60'	CUSTOM HOUSEBOAT, '78	SAUSALITO	\$295,000
57'	NORTHERN MARINE TRAWLER, '04	ANACORTES	\$1,650,000
53'	BLUEWATER, '80	SACRAMENTO	\$116,500
50'	GULFSTAR CC, '79	SAN RAFAEL	\$124,000
50'	OCEANSTAR TRAWLER, '07	MARINA DEL REY	\$499,000
50'	CSK CAT, '70	BERKELEY	\$99,500
48'	DEFEVER TRI-CABIN, '80	EMERYVILLE	\$185,000
47'	BENETEAU 473, 3-stateroom, '06	SAN DIEGO	\$299,000
46'	HUNTER 460, '00	SAN PEDRO	\$217,500
45'	MORGAN by CATALINA center cockpit, '92	SAN DIEGO	\$159,000
43'	PETERSON SERENDIPITY, '81	BRISBANE	\$76,500
42'	MARINE TRADER TRAWLER	DELTA	INQUIRE
41'	HUNTER AC standard interior, '04	SAN DIEGO	\$165,000
38'	MORGAN 38.5 SLOOP, '78	NEWPORT BEACH	\$42,500
37'	O'DAY, '79	RICHMOND	\$24,995
37'	RAFIKI, '78	ALAMEDA	\$58,000
33'	TARTAN, '80	ALAMEDA	\$28,000
32'	ISLANDER, '77	SAN DIEGO	\$22,000
31'	HUNTER, '00	MARINA DEL REY	\$52,900
29'	HADLEY NICOLE CAT, '68	RICHMOND	\$22,500

Details at [www.rbyachts.com](http://www.rbyachts.com)

**\$50,000,000 IN PRE-OWNED BOATS**

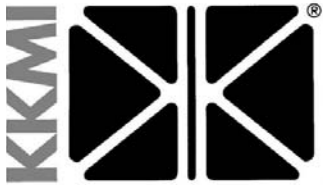

# Maritime Yacht Brokerage

☎(510) 236-6633 • fax: (510) 231-2355

yachtsales@kkmi.com • www.kkmi.com

530 W. Cutting Blvd., Pt. Richmond, CA 94804

## LIST WITH US!

Ask us about our  
Maritime Protection  
Program to find out what  
a warranty can do for  
the sale of your yacht!



### Nelson Marek Custom

A 92-ft aluminum world cruiser. Recently repowered. Immaculate throughout and in perfect condition. **\$2,850,000**



**Herreshoff 'Mobjack' Ketch** (1989) This classic wooden ketch took more than 8 years to complete. Exceptionally well maintained w/a very comfortable and appointed interior layout, she has excellent sailing characteristics for cruising in all weather conditions. **\$180,000**



**Sydney 36 CR** (2006) w/fractional rig, 4 swept-back spreaders, non-overlapping head sail, high aspect ratio & very long waterline. Competitive IRC racer. Fitted w/all factory options incl. electric winches, ideal for short-handed sailing. Consider trade such as 'picnic' style powerboat. *Encore's* fast, fun & easy to sail. **\$295,000**



### Beneteau First 40.7 (2001)

*White Dove* has just won the 2008 West Coast IRC Championship and is in top condition. Asking **\$160,000**



### DeVries 86' Motor Vessel (1949/1999)

'Elegant', 'Exceptional', 'Exquisite' are just a few words that easily characterize this vessel. *MV Far Niente* clearly defines the term 'Classic Motor Yacht'. Asking **\$1,950,000**



### Custom Steel Pilothouse LRC 63 (1976)

Ready-to-go global cruiser just completed \$100,000 maintenance/upgrade service. Twin 185hp Perkins for economy and dual gensets. Three cabins + crew's quarters. Asking **\$389,000**



**Swan 53 Blue Swan** Hydraulic lifting daggerboard, twin-rudder version. Extensively equipped and ready for bluewater cruising. The three-cabin layout makes her one of the most versatile and comfortable Swans ever built. Asking **\$1,350,405**



### Swan 53 (1987)

*Mistress* has been exceptionally well maintained by a professional crew and is a beautiful Swan 53. Her factory-installed aft companionway makes her much more accessible than the standard 53. She has a new teak deck and is in excellent shape. **Sale Pending**



### Swan 43 (1977)

Designed by S&S and with the Nautor Swan pedigree for engineering and construction, this one-owner center cockpit yacht is exceptionally maintained, fully outfitted and ready to go offshore cruising. It is a 'Must See'. Asking **\$189,000**



### Swan 45 (2003)

Race or cruise. *Rancho Deluxe* won her class in the TransPac and was second twice in the Big Boat Series. This boat has all the gear to go cruising and is in perfect condition. **\$625,000**



### Swan 371 (1981)

A Ron Holland design which is very well equipped with newer electronics, sails and has been well maintained. Asking **\$120,000**



### Santa Cruz 52 (1993)

Beautiful, fast cruiser, set up for shorthanded sailing. Maintained to very high standards, the hull has been repainted in stunning red with new bottom paint. Asking **\$490,000**





# Marotta Yachts of Sausalito

Brokers of Fine Sail and Motor Yachts

415-331-6200 • info@marottayachts.com

See at: [www.marottayachts.com](http://www.marottayachts.com)



45' HUNTER 450, 1998

All the amenities one would expect from Hunter with two spacious staterooms, two heads, very functional galley area and HUGE comfortable salon. This low time vessel is in nice shape overall and lying in a transferable Sausalito Yacht Harbor slip. She'll make an ideal Sausalito pied-a-terre. All in all a great turn-key package and competitively priced to boot!

\$169,500

See at: [www.marottayachts.com](http://www.marottayachts.com)



TWO 38' HANS CHRISTIANS, 1984 & 1979

The 38 Traditional is a lovely modern classic and these particular examples are very nice inside and out. Some highlights: new main in 2003, new roller furler in 2001, all new electronics in 2001, epoxy barrier-coated bottom painted 2001.

\$134,900 & \$99,000

See at: [www.marottayachts.com](http://www.marottayachts.com)



37' HUNTER 376, 1999

Very spacious, light and airy, one of Hunter's most successful designs. Vessel shows as new, must see to appreciate. She's also very competitively price, out-of-country owners motivated and offers encouraged. In addition, note Sausalito Yacht Harbor slip can be arranged; there is a significant waiting list to get into this marina.

\$99,000

See at: [www.marottayachts.com](http://www.marottayachts.com)



36' CASCADE CUTTER, 1989

Custom-built raised cabintop cutter that was designed specifically for a cruise that was never taken, almost \$30,000 spent over the past couple of years. She shows very nicely today — new electronics, new sails and rigging, low time on the Yanmar diesel and a hard dodger that's a work of art. She's ready to head anywhere you see fit.

\$89,000

See at: [www.marottayachts.com](http://www.marottayachts.com)



34' SUNSET SLOOP, 1967

This full keeled little jewel was designed as the ultimate Bay daysailer and built like a piano by Al Silva shortly after he left the legendary Stone Boat Yard. Fully restored, she's one of the finest boats of this era we've ever seen; everything's done to showboat standards.

\$69,500

See at: [www.marottayachts.com](http://www.marottayachts.com)



34' HANS CHRISTIAN CUTTER, 1978

The rare Robert Perry-designed HC 34 is a classic cutter that's a very capable offshore boat; with a full keel, high ballast-to-weight ratio, deep cockpit (note it's a bigger, more comfortable cockpit than that on the more common HC 33) and a big rudder placed far aft, she's safe and sea kindly under power or sail. Great shape, transferable Sausalito YH slip.

\$69,000

See at: [www.marottayachts.com](http://www.marottayachts.com)



30' NONSUCH ULTRA, 1987

Professionally maintained late-model example in super nice shape (the interior is flawless and the exterior comes close), and lying in a transferable Sausalito Yacht Harbor slip that has a great Richardson Bay, Angel Island and San Francisco views. All in all, a nice turn key package that must be seen to be appreciated.

\$59,000

See at: [www.marottayachts.com](http://www.marottayachts.com)



20' PACIFIC SEACRAFT FLICKA, 1985

Never cruised, this late-model example was factory built and finished to Pacific Seacraft's exacting standards. She's been updated stem to stern, including new Yanmar diesel, and today shows bristol — one of the nicest Flickas on the market.

\$43,500

See at: [www.marottayachts.com](http://www.marottayachts.com)



32' DREADNAUGHT, 1978

Built down in Carpinteria, these stout double-enders will go anywhere in safety and comfort, plus they have all the charm in the world! This particular example is in very nice shape and lying in a transferable Sausalito Yacht Harbor slip — all in all a very nice, turn key package.

\$29,000

100 BAY STREET • SAUSALITO • CALIFORNIA 94965

# NORPAC YACHTS

1150 Brickyard Cove Rd., B9, Pt. Richmond, CA 94801  
**(510) 232-7200 • FAX (510) 232-7202**  
 email: [info@norpacyachts.com](mailto:info@norpacyachts.com)

**HAPPY DAYS ARE HERE AGAIN!  
 LIST YOUR BOAT NOW: WE HAVE BUYERS!**

**FOR MORE  
 SEE OUR  
[norpacyachts.com](http://norpacyachts.com)  
 WEBSITE**



**CALIFORNIA HISTORICAL VESSEL**  
**43' D.M. CALLIS CLASSIC** 1923 Cust. Express Cruiser, *Marradain*. TEAK masterpiece. Famous from roaming '20s/on: Catalina, Hollywood, etc. Now exquisitely & totally refit w/modern everything discretely incorporated & true to designer's original intent. Exceedingly rare opportunity; AND she is fast! Ask **\$695,000**



**PERFORMANCE**  
**40' X-YACHTS X-119 SLOOP.** Famous Danish builder, Racer-Cruiser one design by Neils Jeppesen. Loaded with gear, radar, New Volvo Penta diesel in 2000 and MORE! Proven ocean winner in Melbourne-Osaka Race. Asking **\$109,000**



**39' FREYA, STRONG STEEL DOUBLE-ENDED CRUISER.** Diesel, dink and outboard. New paint, solar, furling, RADAR, AP, cruise equipped, comfortable, well appointed. A world-class cruiser and MORE! Asking **\$48,950**



**35' COLUMBIA SLOOP.** Very nice and highly desirable "10.7" design. Dsl, full galley, shower, wheel, dodger, bimini, RADAR, AP, Teak and Holly sole & MORE! Cruise equipped and well maintained and upgraded. Asking **\$30,950.**



**STROMA OF MEY**  
**38' CLASSIC ENGLISH KETCH.** Award winning beauty in fine condition. Pitch pine over oak, copper riveted. Dsl, dodger, new teak decks, RADAR, gorgeous interior & MORE! Designed by Reg Freeman, built 1936 by Wm King & Son. Ask **\$124,950**



**REDUCED**  
**40 SAMPSON C-Ghost Cutter, F/C, Mexico.** Vet and ready to go again. Excellent cruiser. Diesel, wheel, dodger, enclosed marine head, shower, galley, AP, GPS, + MORE! Very nice condition and a GREAT VALUE! Asking **\$29,500/offers**



**REDUCED**  
**40' CHALLENGER** Ketch. Gorgeous, Sparkling Performance Cruiser in excellent condition. Dsl, furling, spinn., full galley, encl. head & shower, hardwood interior, wheel, pedestal, full lifelines & pulpits, inverter, Avon & o/b. MUCH MORE! Shows pride of ownership. Asking **\$58,950**



**BARGAIN CLASSIC CRUISER**  
**65' CLASSIC, '31 MOTORYACHT BY WHEELER.** 16' beam, recent 40k hull refurb. She's ready for you to finish restoration. 3 db/stems, pilothouse, twins, 3 heads, huge salon, crew's quarters and more. **\$39,500/offers**



**REDUCED**  
**50' TRUMPY** raised pilothouse TRAWLER. Strong, comfortable, seakindly & economical. RADAR, AP, Detroit 671-N main, 2 heads, shower, tub, dbl & queen stms, full galley, lg salon, dbl plank. Built by famous John Trumpy Yard. Project boat. MUST SEE. **\$44,950/offers**



**UNIQUE**  
**48' DUTCH CANAL BARGE** by DeVries. STEEL. Unique cruising liveboard for Bay and Delta. Comfort and character. Diesel, tub, galley, fireplace, salon, convertible aft enclosure, beautiful decor, plus MORE! Asking **\$219,000**

**SAIL**

100' MEGA SLOOP Custom Offshore Performance Cruiser. Comfort & luxury, spacious, sleeps 17, loaded and near new. GREAT CHARTER POTENTIAL!!!... Asking 975,000  
 43' STEEL Custom Cutter. Built by Bechtel Corp. for Pan Am Airlines. An exquisite canoe-stern, center cockpit gem. Just refit & BEAUTIFUL. Aft S/R, wheel, breathtaking... Ask 78,950  
 42' Sparkman & Stephens Performance Cruising Sloop. Diesel, dodger, F/G, many upgrades & new rig... Asking 41,950  
 40' TRIMARAN by Piver. Ketch, dsl, fast, nice, clean. Insures as F/G... Asking 33,900  
 38' INGRID Ketch by Atkins. Great extra STOUT BLUE WATER CRUISER. Glass double-ender, refit & upgraded, vane, diesel, furling, RADAR & MORE!... Asking 51,950  
 37' ISLANDER Sloop. Inboard, ever popular "Plastic Classic"... Asking 18,950  
 37' GULFSTAR Center Cockpit Slp. Dsl, dodger, aft S/R & MORE. This VESSEL MUST BE SOLD NOW! REPO!... Ask: 29,950/Make Offers  
 34' FELLOWS & STEWART Ketch. Diesel... Asking 19,500  
 33+ ROYAL HUISMAN ALUMINUM Cutter by Alan Gurney. World class builder and designer. Yanmar diesel, new standing rig, nav station, liferaft & MORE!... Ask 38,500  
 31' PACIFIC SEACRAFT MARIAH cutter. Strong, F/G double-ender bluewater cruiser. Dsl, wheel, furl, dodger, radar ++. Great, beautiful boat... Ask 68,950  
 30+ STEEL SPRAY Replica by Bruce Roberts. This is a NEW BOAT, never launched. Joshua Slocum's famous Spray design w/diesel, spars, sails & more! Exterior looks ready to launch. Interior started, but not finished. AHoy BARGAIN HUNTERS!!! This looks like a good one... Asking only 14,900  
 30' PT 30 Mk II / 2-ton Britton Chance design. 5 berths, full headroom, solid F/G hull, furling, dsl, 3 headsails (135% & #4 gennies, 3/4 & 1.5 oz kites), spinn., main... 7,450  
 30' SAGITTA Sloop. F/G, diesel, fine Danish double-ender... Reduced... Ask 14,950  
 30' CATALINA Slp. Dsl, wheel, nice... 22,000  
 29' PEARSON TRITON. Diesel, much refitting recently done, some left to do, very nice pocket cruiser... 15,950/offers  
 27' BALBOA Sloop. Diesel auxiliary, wheel, standing headroom, 2-axle EZ-loader trailer. Lyle Hess design, GPS, VHF, extra clean & MORE!... Reduced! Asking 10,475  
 27' CAL 2-27 Slp. Extra nice, 1/B. Ask 5,750

**100' STEEL HIGH ENDURANCE ADVENTURE/CHARTER SHIP & Business in Panama. Successful & turn-key operation. Great opportunity! MOTIVATED! ... 2,250,000/offers**

62' TRUMPY Classic 1946 Ocean Cruising Yacht. Gorgeous interior & super comfortable layout. Exterior refinish/restore due. Economical twin 4-71s ++. OFFERS ENCOURAGED... Asking 149,500  
 62' ELCO 1929 CLASSIC Twin diesel, beautiful yachting in the classic Gatsby style... Ask 129,500  
 49' CLASSIC 1928 STEPHENS Raised Deck Express Cruiser. Twin 671 dsls, much recent prof. upgrading, fire damaged aft cockpit. Great opportunity... 24,950/offers  
 45' STEPHENS 1929 classic. Beautiful Gatsby-era motoryacht waiting to transport you back to the days of yachting in the grand style... Try 75,000  
 43' MATTHEWS, '65, diesel. A gem! Loaded and beautiful... Asking 69,450  
 42' GRAND BANKS Tvl. Aft cabin, F/B, Onan, twin dsls, radar. Excellent... 121,000  
 41' CHRIS CRAFT Const. Twins, aft S/R, bridge up and more. A good cruiser or liveboard... 13,950/offers

**34' CLASSIC LAKE UNION DREAMBOAT, 1928.** Dsl, full aft convert, enclosure and much more!... A BARGAIN @ 17,500 Asking

32' BOWPICKER, aluminum. Commercial (herring) license... 49,000  
 32' GRAND BANKS Trawler. Classic '70. Dsl, dual helms, full electronics, TEAK decks, economical + MORE!... BARGAIN! 19,500 Ask  
 29' WELLCRAFT 2900 EXPRESS. Twin screw (not outdrives). Super clean & nice! Bright red... REDUCED! Asking 19,950  
 28' CARVER. Dual steering stations. Unusually roomy for this size class, the Carvers are known for their good construction & creature comforts. Nice boat with exquisite restoration... REDUCED! GREAT BUY! 11,950  
 27' FARALON Pilothouse, '86. F/G, twin 5L V8s, fast and seaworthy. Just detailed and very nice... Asking 51,950  
 26' PACEMAKER, cabin cruiser/V8, nice!... 8,500  
 24' COUNTER-STERM TRADITIONAL YACHT TENDER/LAUNCH with Cuddy. Copper bottom. A BEAUTY. YANMAR diesel... 12,950/obo  
 19' CHRIS CRAFT CONCEPT 119 Bowrider Runabout, '93. With canvas, inboard 40 mph low hours, dry-stored inside. Good looking fiberglass fun machine... A BARGAIN @ 3,950



**GREAT BUY**  
**34' DUFOUR** sloop. Diesel, enclosed head and shower. Full galley, spinnaker, nav. station, wheel steering. TEAK and holly sole and more. Excellent performer with quality construction and lots of room (6'6"+headroom). Asking **\$27,500/offers**



**48' C&C**  
 Beautiful, comfortable and immaculate BLUE WATER PERFORMANCE CRUISER with all the bells and whistles & a great Sausalito berth. Ready to go to sea. Low hours 80 hp diesel. Wonderful interior and MORE. Asking **\$174,500**



**READY TO CRUISE**  
**39' SANTANA** by Gary Mull & W.D. Schock. Great designer & builder. Exceptional cond. Perfectly set up for cruising. Strong, seaworthy & comfortable. Wheel, dodger, radar, VHF, GPS, AP, depth, spinnaker, etc. VERY NICE! Ask **\$55,500**



**REDUCED!**  
**22' ALUMINUM BUFFLEHEAD TUG** by MacNaughton Assoc. Dsl, radar, GPS, shower, private S/R, Zodiac & O/B, inverter, seaworthy & trailerable. Near new & excellent. Berthed in Vancouver, BC. Fun with character & practicality & MORE! Ask **\$108,250**

**POWER**

130' CAMCRAFT Passenger Ship. Certified for 33 passengers overnight. Booked for the season. Virtual turnkey: Money and opportunity, working PNW... 2,200,000

**CALL (510) 232-7200 OR FREE (877) 444-5087  
 OR CALL GLENN DIRECT AT (415) 637-1181  
 FOR INFORMATION & INSPECTION APPOINTMENTS**





**KKMI** **KEEFE**  
**KAPLAN**  
**MARITIME, INC.**

Your Complete Maritime  
Service Center

Yeah, we're flippin' crazy

**FREE HAULOUTS**

with Bottom Painting Packages, the  
price we quote is the price you pay!

Got a Saildrive?

**7** Things you  
should know  
about how to  
properly main-  
tain it, [kkmi.com](http://kkmi.com)

**ELECTRONICS**  
**MECHANICS**  
**RIGGING**

If you own a yacht and it needs attention, KKMI is the place to go. Not only do they have the best professional talent, it is delivered in a timely manner. What more can you ask for!

Thanks, KKMI for the great service,  
Charles Rixford, 'Widgeon' Bird Boat

**UNBEATABLE VALUE...**  
**TEST US! CALL TODAY**

530 W. Cutting Blvd. Pt. Richmond, CA 94804  
Office (510) 235-5564 Chandlery (510) 237-4141  
email [yard@kkmi.com](mailto:yard@kkmi.com) • [www.KKMI.com](http://www.KKMI.com)